

CDSF4148-HF(RoHS Device)

High Speed

Features

Halogen free.

Designed for mounting on small surface.

Extremely thin/leadless package.

High mounting capability, strong surge withstand, high reliability.

Use in sensitive electronics protection against voltage transients induced by inductive load switching and lighting on ICs, MOSFET, signal lines of sensor units for consumer, computer, industrial, automotive and telecommunication.



Mechanical data

Case: 1005(2512) standard package, molded plastic.

Terminals: Gold plated, solderable per MIL-STD-750, method 2026.

Polarity: Indicated by cathode band.

Mounting position: Any

Weight: 0.006 gram(approx.).

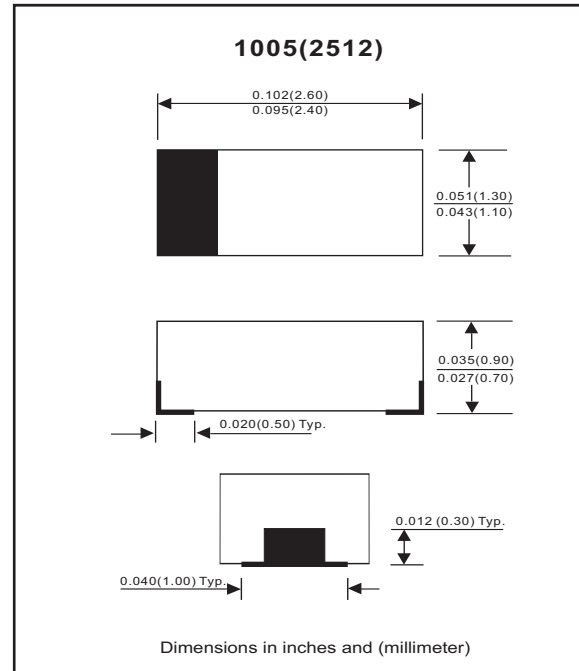

Maximum Rating (at TA=25°C unless otherwise noted)

Parameter	Conditions	Symbol	Min	Typ	Max	Unit
Reverse voltage		V _{RRM}			100	V
Reverse voltage		V _R			75	V
Average forward current		I _O			150	mA
Forward current,surge peak	T _P = 1μS T _P = 1mS	I _{FSM}		4 1		A
Repetitive peak forward current		I _{FRM}			300	mA
Power dissipation		P _D			350	mW
Thermal resistance junction to ambient air		R _{θJA}			286	°C/W
Storage temperature		T _{STG}	-40		+125	°C
Junction temperature		T _J			+125	°C

Electrical Characteristics (at TA=25°C unless otherwise noted)

Parameter	Conditions	Symbol	Min	Typ	Max	Unit
Reverse breakdown voltage	I _R = 100 μA	V _{BR}	75			V
Forward voltage	I _F = 50 mA DC	V _F			1.0	V
Reverse current	V _R = 20 V V _R = 75 V	I _R			25 2.5	nA μA
Capacitance between terminals	f = 1 MHz, and 0VDC reverse voltage	C _T			4	pF
Reverse recovery time	I _F = I _R = 10 mA, R _L = 100 ohms, I _{rr} = 1 mA	T _{rr}			4	nS

RATING AND CHARACTERISTIC CURVES (CDSF4148-HF)

Fig. 1 - Forward characteristics

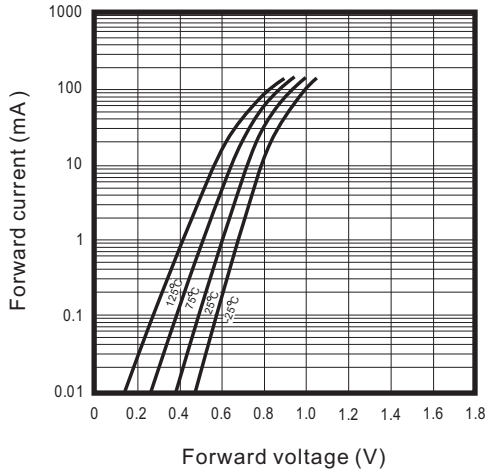

Fig. 2 - Reverse characteristics

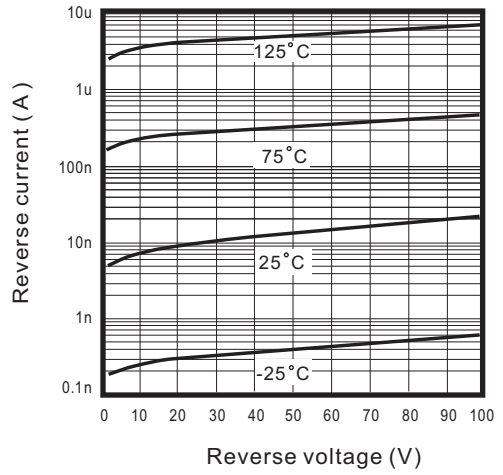

Fig. 3 - Capacitance between terminals characteristics

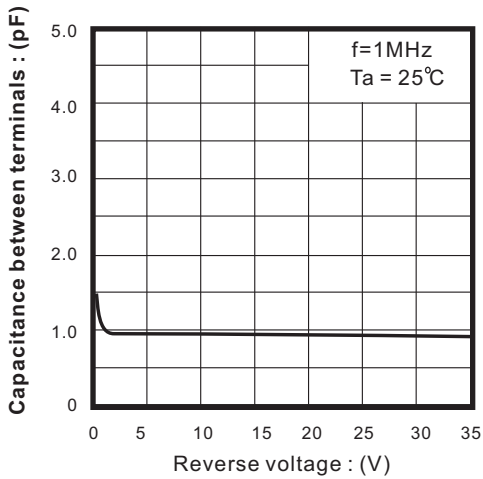
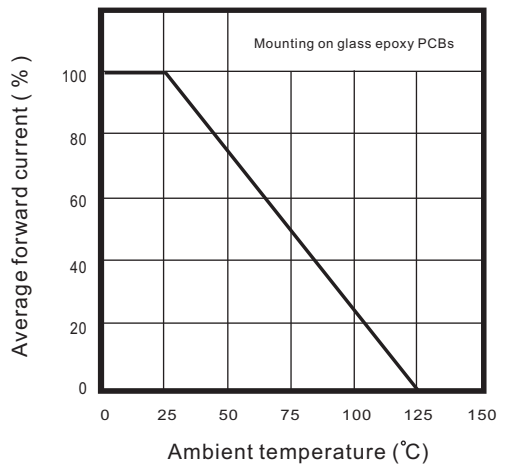
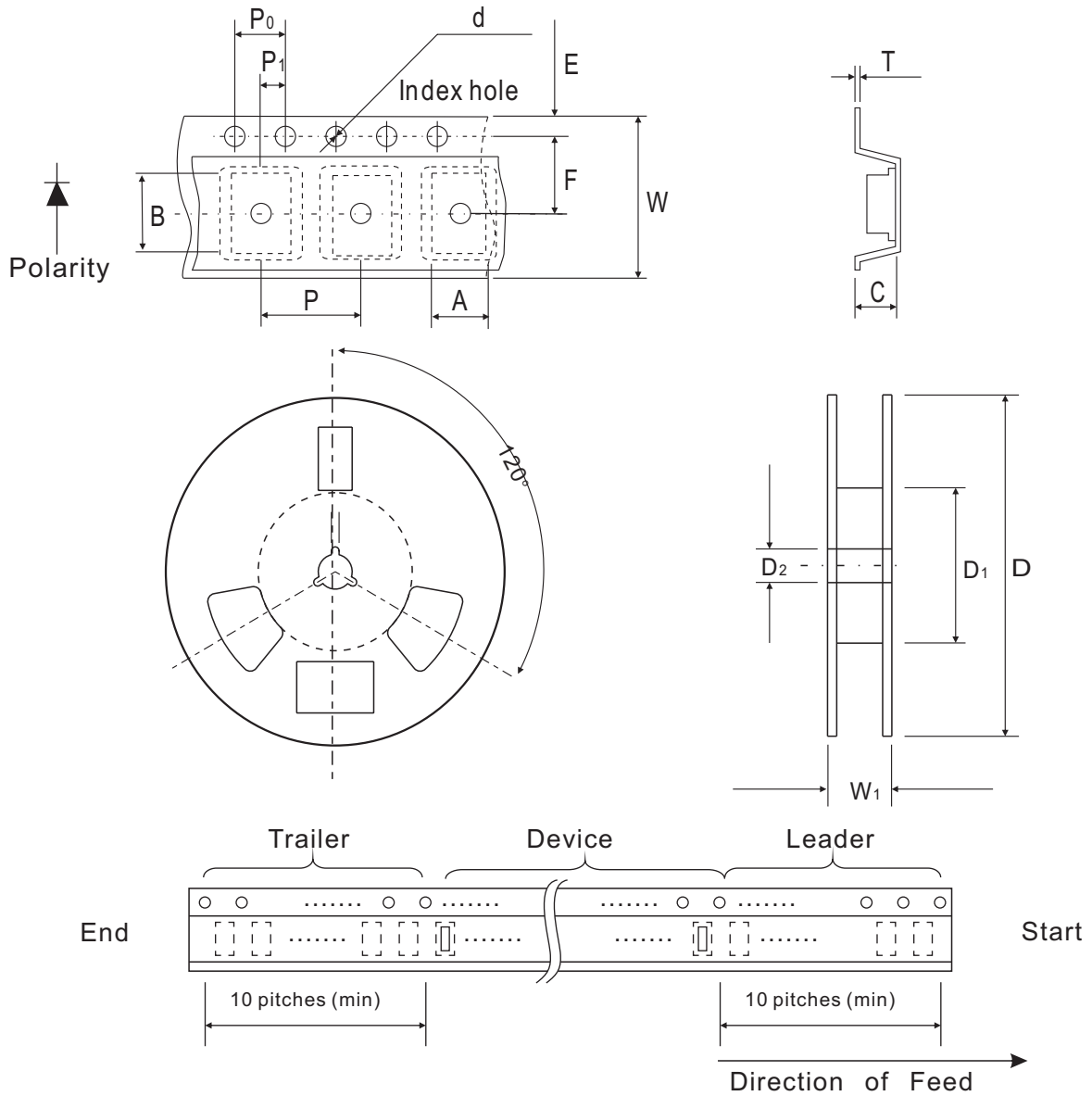

Fig. 4 - Current derating curve



Reel Taping Specification



F/1005	SYMBOL	A	B	C	d	D	D ₁	D ₂
	(mm)	1.55 ± 0.10	2.65 ± 0.10	1.05 ± 0.10	1.55 ± 0.05	178 ± 1	60.0 MIN.	13.0 ± 0.20
	(inch)	0.061 ± 0.004	0.104 ± 0.004	0.041 ± 0.004	0.061 ± 0.002	7.008 ± 0.04	2.362 MIN.	0.512 ± 0.008

F/1005	SYMBOL	E	F	P	P ₀	P ₁	T	W	W ₁
	(mm)	1.75 ± 0.10	3.50 ± 0.05	4.00 ± 0.10	4.00 ± 0.10	2.00 ± 0.05	0.23 ± 0.05	8.00 ± 0.20	13.5 MAX.
	(inch)	0.069 ± 0.004	0.138 ± 0.002	0.157 ± 0.004	0.157 ± 0.004	0.079 ± 0.004	0.009 ± 0.002	0.315 ± 0.008	0.531 MAX.

Suggested PAD Layout

SIZE	F/1005	
	(mm)	(inch)
A	2.10	0.083
B	1.20	0.047
C	1.20	0.047
D	3.30	0.130
E	0.90	0.035

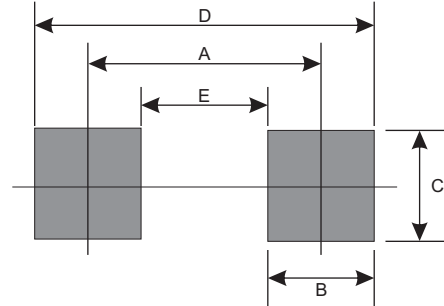

Standard Package

Case Type	Qty per Reel	Reel Size
	(Pcs)	(inch)
F/1005	4000	7