

FEATURES

- * SELECTED TO SPECIFIC ON-LINE INTENSITY AND RADIANT INTENSITY RANGES
- * LOW COST MINIATURE PLASTIC SIDE LOOKING PACKAGE
- * MECHANICALLY AND SPECTRALLY MATCHED TO THE LTR-5888DH SERIES OF PHOTOTRANSISTOR

PACKAGE DIMENSIONS

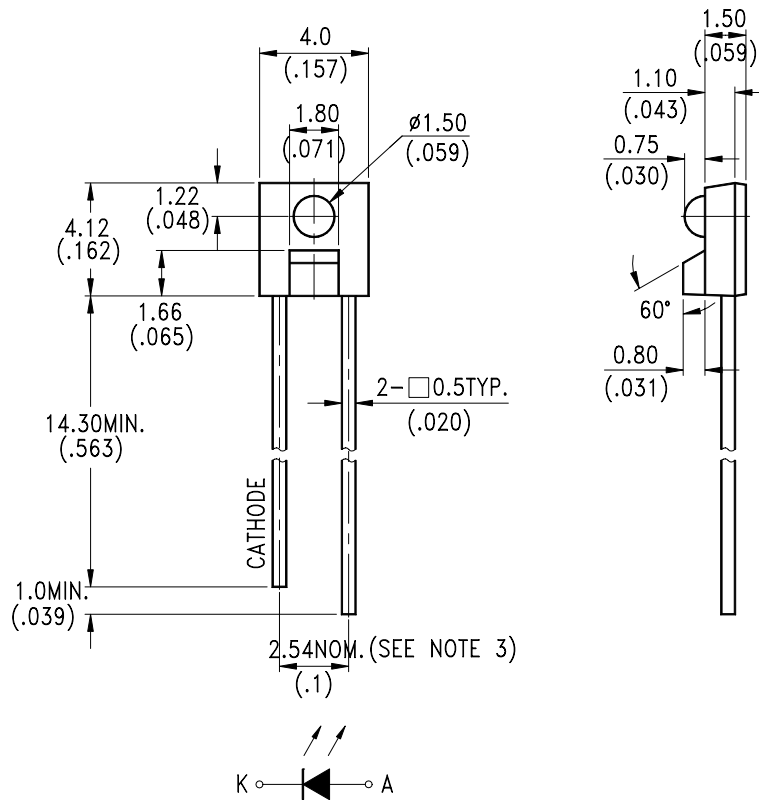

NOTES:

1. All dimensions are in millimeters (inches).
2. Tolerance is $\pm 0.25\text{mm}(.010\text{'})$ unless otherwise noted.
3. Lead spacing is measured where the leads emerge from the package.
4. Specifications are subject to change without notice.



LITE-ON TECHNOLOGY CORP.

LITE-ON INTERNAL DATA

ABSOLUTE MAXIMUM RATINGS AT TA=25°C

PARAMETER	MAXIMUM RATING	UNIT
Power Dissipation	75	mW
Peak Forward Current (300pps, 10 μ s pulse)	1	A
Continuous Forward Current	50	mA
Reverse Voltage	5	V
Operating Temperature Range	-10°C to + 50°C	
Storage Temperature Range	-55°C to + 100°C	
Lead Soldering Temperature [1.6mm(.063") From Body]	260°C for 5 Seconds	

ELECTRICAL / OPTICAL CHARACTERISTICS AT TA=25°C

PARAMETER	SYMBOL	MIN.	TYP.	MAX.	UNIT	TEST COND.	BIN No.	Color Marking
Peak Emission Wavelength	λ_P		940		nm	$I_F = 20\text{mA}$		
Spectral Line Half-Width	$\Delta \lambda$		50		nm	$I_F = 20\text{mA}$		
Forward Voltage	V_F		1.2	1.6	V	$I_F = 20\text{mA}$		
Reverse Current	I_R			100	μA	$V_R = 5\text{V}$		
Average Axis Intensity (Light Current) Setting of LITE-ON Production $(I_{L1}+I_{L2})/2$	I_L	0.25		0.35	mA	$I_F = 4\text{mA}$ $V_{CC}=3.5\text{V}$	BIN C	Blue
		0.35		0.45			BIN D	Green
		0.45		0.55			BIN E	Black
		0.55		0.65			BIN F	Red
		0.65		0.75			BIN G	Gold
		0.75		0.85			BIN H	Silver
		0.85		-			BIN I	Yellow
Average Axis Intensity (Light Current) Q.C Limits $(I_{L1}+I_{L2})/2$	I_L	0.20		0.42	mA	$I_F = 4\text{mA}$ $V_{CC}=3.5\text{V}$	BIN C	Blue
		0.28		0.54			BIN D	Green
		0.36		0.66			BIN E	Black
		0.44		0.78			BIN F	Red
		0.52		0.90			BIN G	Gold
		0.60		1.02			BIN H	Silver
		0.80		-			BIN I	Yellow
Viewing Angle (See FIG.6)	$2\theta_{1/2}$		40		deg.			

INFRARED AXIS INTENSITY TEST METHOD

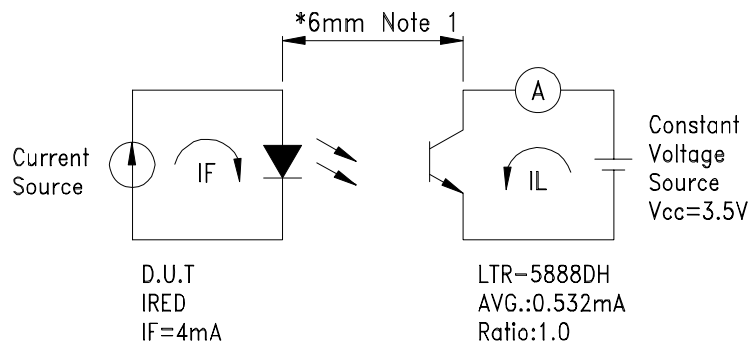

NOTE: 1. Lead frame to Lead frame

TYPICAL ELECTRICAL / OPTICAL CHARACTERISTICS CURVES

(25°C Ambient Temperature Unless Otherwise Noted)

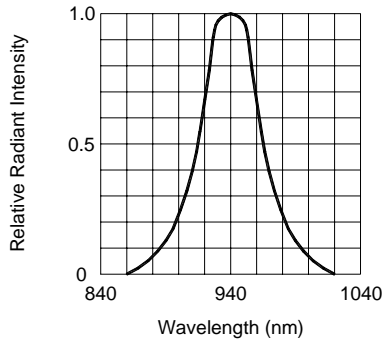

FIG.1 SPECTRAL DISTRIBUTION

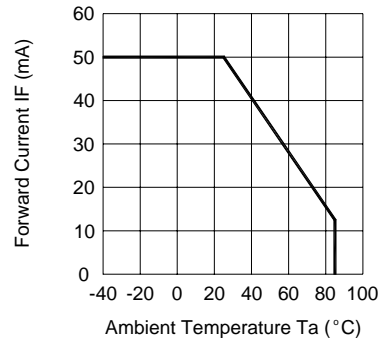

FIG.2 FORWARD CURRENT VS. AMBIENT TEMPERATURE

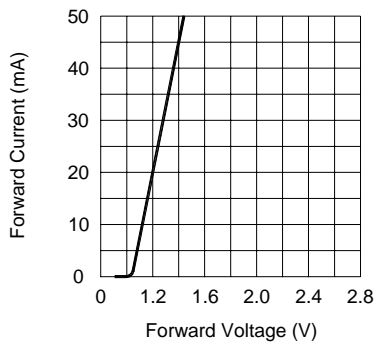

FIG.3 FORWARD CURRENT VS. FORWARD VOLTAGE

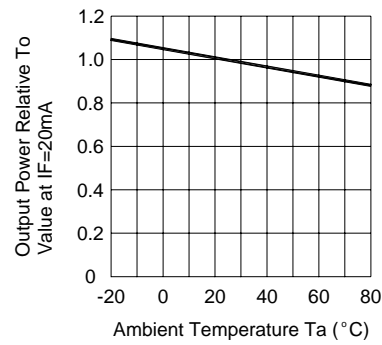

FIG.4 RELATIVE RADIANT INTENSITY VS. AMBIENT TEMPERATURE

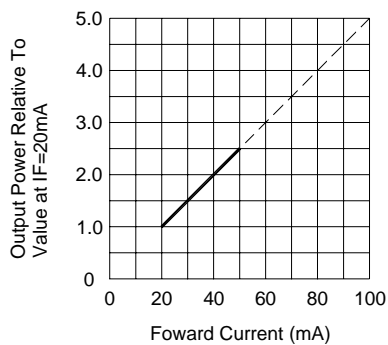

FIG.5 RELATIVE RADIANT INTENSITY VS. FORWARD CURRENT

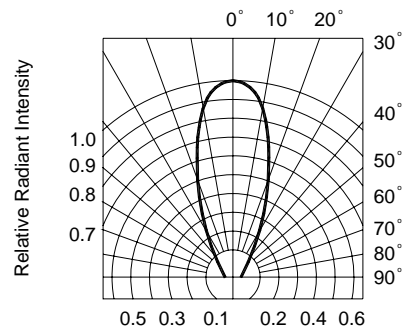

FIG.6 RADIATION DIAGRAM