

1SS315

SILICON EPITAXIAL SCHOTTKY BARRIER DIODE

Applications

- UHF Band Mixer

PINNING

PIN	DESCRIPTION
1	Cathode
2	Anode

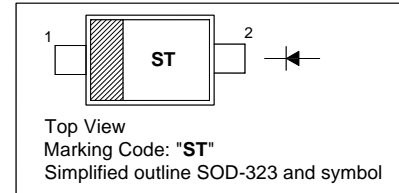

Absolute Maximum Ratings ($T_a = 25\text{ }^\circ\text{C}$)

Parameter	Symbol	Value	Unit
Peak Reverse Voltage	V_{RM}	5	V
Forward Current	I_F	30	mA
Junction Temperature	T_J	125	$^\circ\text{C}$
Storage Temperature Range	T_{stg}	- 55 to + 125	$^\circ\text{C}$

Electrical Characteristics at $T_a = 25\text{ }^\circ\text{C}$

Parameter	Symbol	Min.	Typ.	Max.	Unit
Forward Current at $V_F = 0.5\text{ V}$	I_F	30	-	-	mA
Reverse Current at $V_R = 0.5\text{ V}$	I_R	-	-	25	μA
Total Capacitance at $V_R = 0.2\text{ V}$, $f = 1\text{ MHz}$	C_T	-	0.6	-	pF

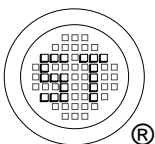

SEMTECH ELECTRONICS LTD.

(Subsidiary of Sino-Tech International Holdings Limited, a company listed on the Hong Kong Stock Exchange, Stock Code: 724)



ISO/TS 16949 : 2002 Certificate No. 05103
ISO 14001:2004 Certificate No. 7116
ISO 9001:2000 Certificate No. 0506098

Dated : 01/09/2006

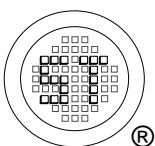
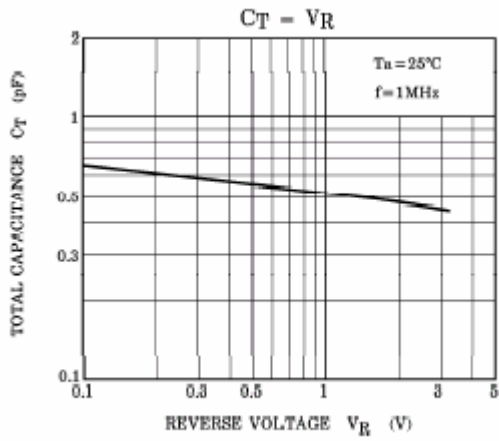
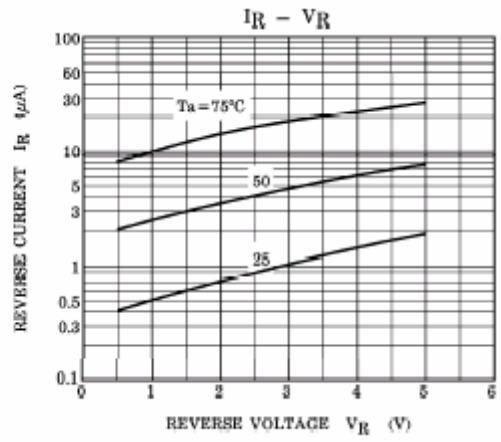
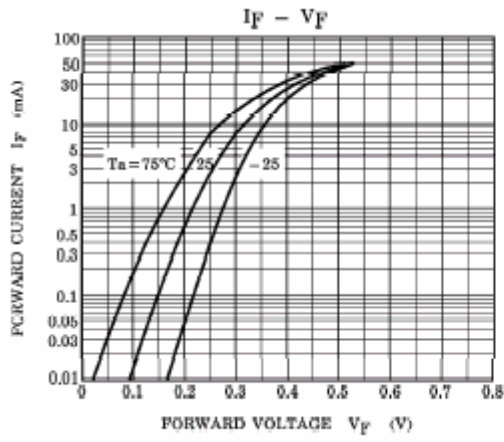

SEMTECH ELECTRONICS LTD.
 (Subsidiary of Sino-Tech International Holdings Limited, a company listed on the Hong Kong Stock Exchange, Stock Code: 724)



PACKAGE OUTLINE

Plastic surface mounted package; 2 leads

SOD-323

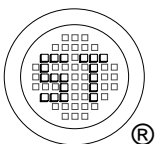
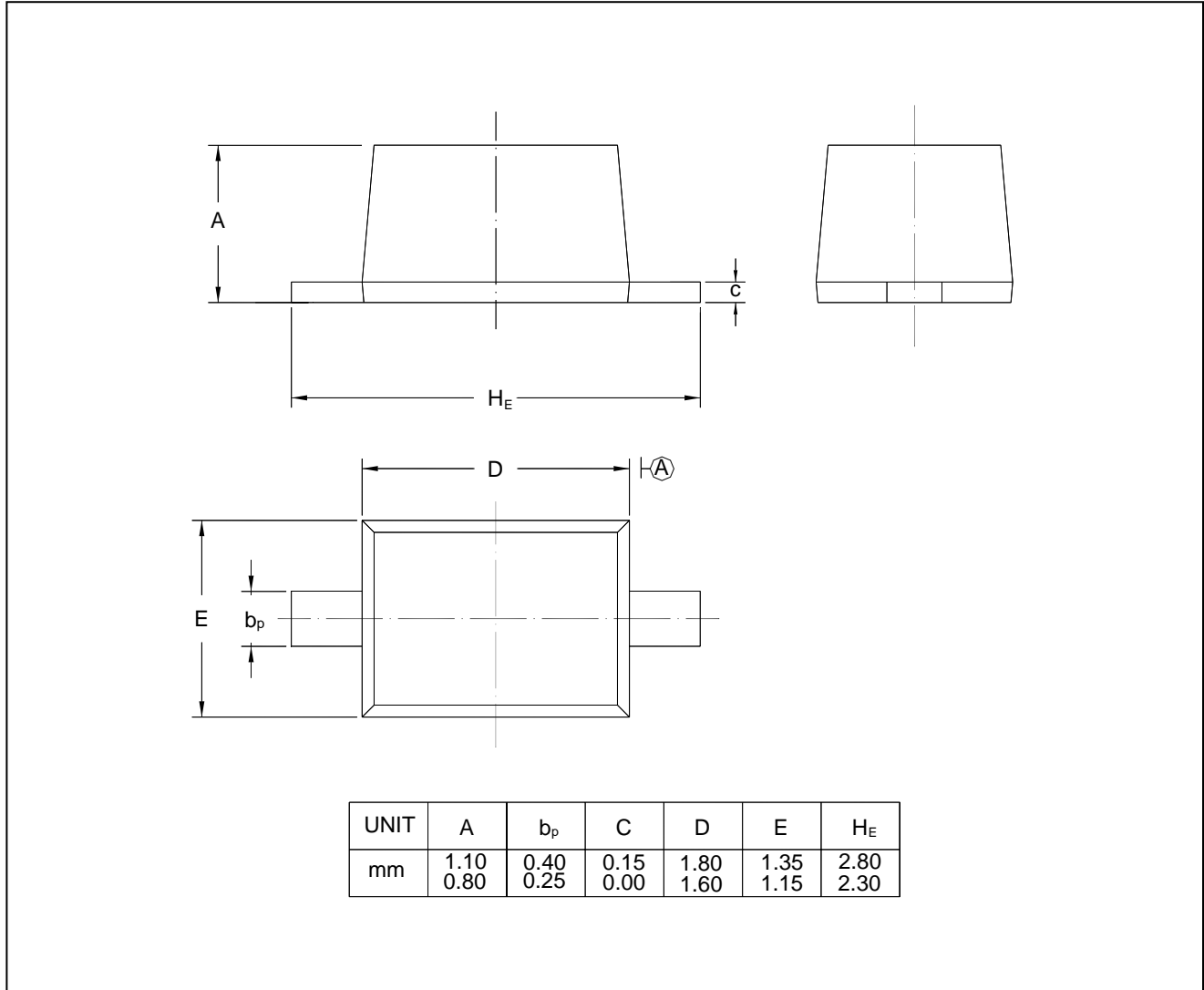

SEMTECH ELECTRONICS LTD.
 (Subsidiary of Sino-Tech International Holdings Limited, a company
 listed on the Hong Kong Stock Exchange, Stock Code: 724)



Dated : 01/09/2006