

MZ9313 / MZ9313C

Triple-Balanced Mixer

Rev. V3

Features

- LO 2 TO 18 GHz
- RF 2 TO 18 GHz
- IF 0.03 TO 5 GHz
- LO DRIVE: +13 dBm (NOMINAL)
- MINIATURE PACKAGE
- WIDE BANDWIDTH
- AVAILABLE WITH FIELD REPLACEABLE CONNECTORS

Description

The MZ9313 is a triple balanced mixer, designed for use in military, commercial and test equipment applications. The design utilizes Schottky ring quad diodes and broadband soft dielectric baluns to attain excellent performance. The use of high temperature solder and welded assembly processes used internally makes it ideal for use in manual, semi-automated assembly. Environmental screening available to MIL-STD-883, MIL-STD-202 or MIL-DTL-28837, consult factory.

Product Image

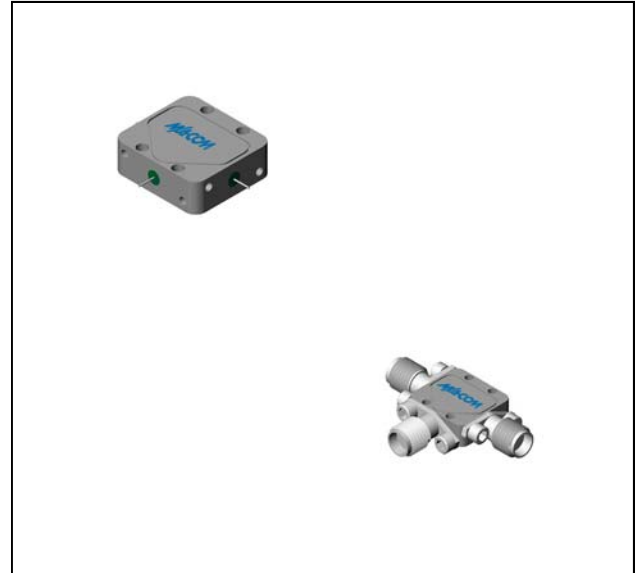

Ordering Information

Part Number	Package
MZ9313	Versapac
MZ9313C	SMA Connectorized

Electrical Specifications: $Z_0 = 50\Omega$ $Lo = +13$ dBm (Downconverter application only)

Parameter	Test Conditions	Units	Typical	Guaranteed	
				+25°C	-54° to +85°C
SSB Conversion Loss (max) & SSB Noise Figure (max)	fR = 4 to 18 GHz, fL = 2 to 18 GHz, fl = 0.03 to 3 GHz	dB	6.5	9.0	9.5
	fR = 2 to 18 GHz, fL = 2 to 18 GHz, fl = 0.03 to 5 GHz	dB	7.5	10.5	11.0
Isolation, L to R (min)	fL = 2 to 4 GHz	dB	17	12	10
	fL = 4 to 18 GHz	dB	30	15	13
Isolation, L to I (min)	fL = 2 to 18 GHz	dB	30	17	15
1 dB Conversion Comp.	fL = +13 dBm	dBm	+8		
Input IP3	fR1 = 3 GHz at -10 dBm, fR2 = 3.01 GHz at -10 dBm, fL = 5 GHz at +13 dBm	dBm	+19		
	fR1 = 17.99 GHz at -10 dBm, fR2 = 18 GHz at -10 dBm, fL = 14 GHz at +13 dBm	dBm	+15		

Typical Performance Curves

Conversion vs. LO Power

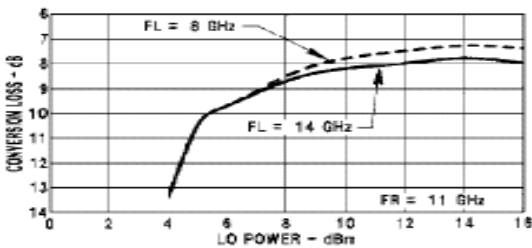

Conversion vs. Frequency

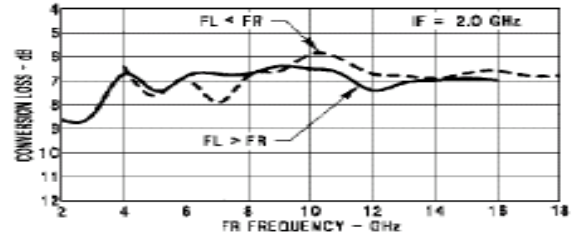

Conversion vs. Frequency

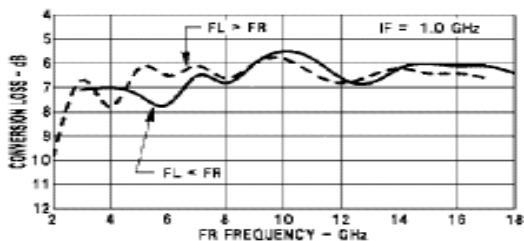
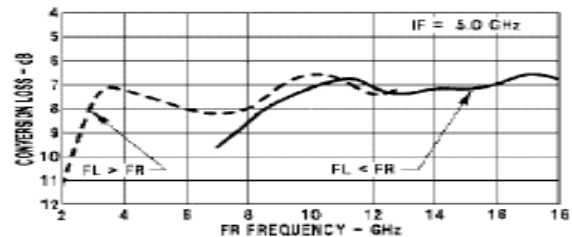
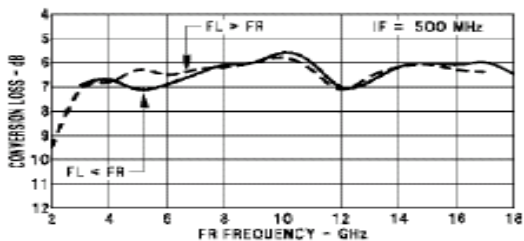
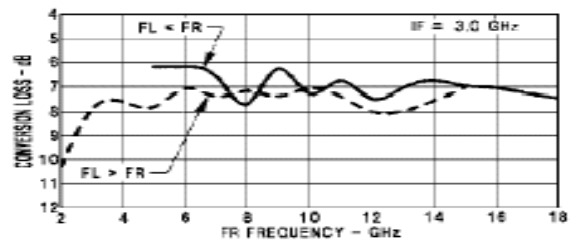
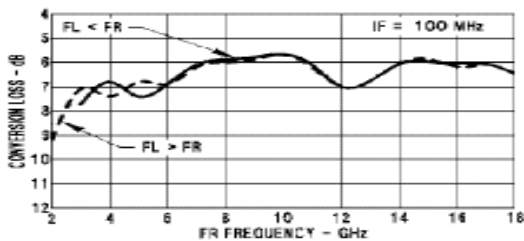

L-Port VSWR vs. Frequency

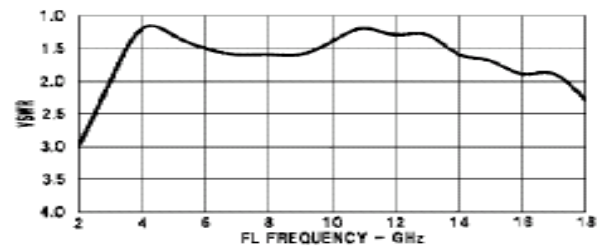

MZ9313 / MZ9313C



Triple-Balanced Mixer

Rev. V3

Absolute Maximum Ratings

Parameter	Absolute Maximum
Operating Temperature	-54°C to +100°C
Storage Temperature	-65°C to +100°C
Peak Input Power	+26 dBm max @ +25°C +23 dBm max @ +100°C
Peak Input Current	mA DC

Outline Drawing: Versapac *

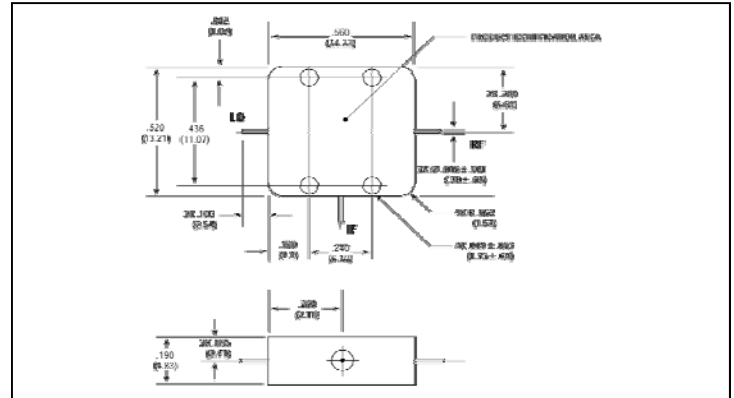

Weight: 4 grams (0.14 oz.) max

Outline Drawing: SMA Connectorized *

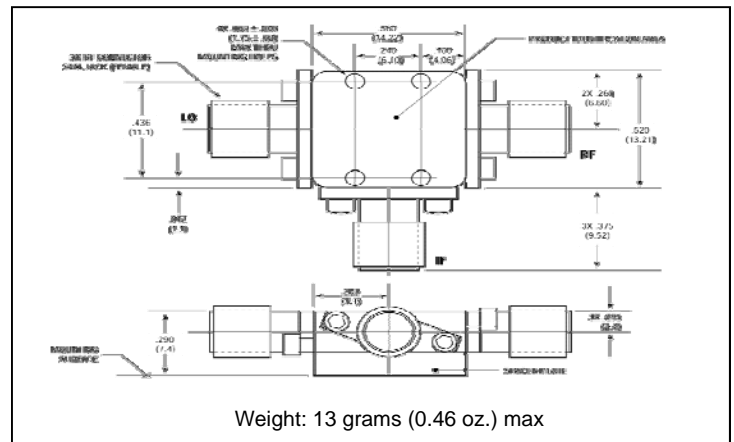

Weight: 13 grams (0.46 oz.) max

Isolation vs. Frequency

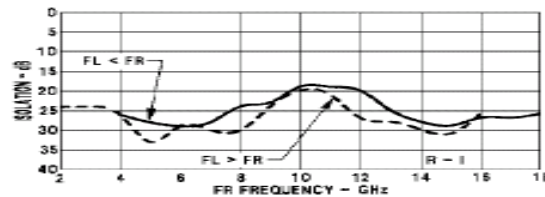
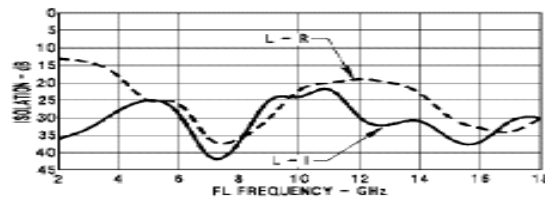

R-Port VSWR vs. Frequency

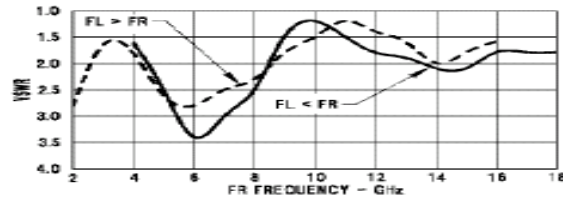

I-Port VSWR vs. Frequency

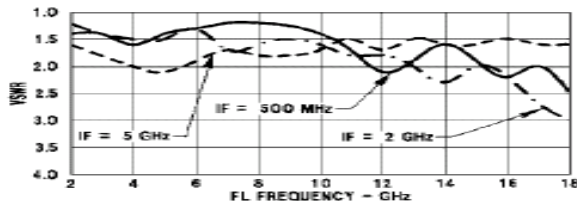

* Dimensions are inches (millimeters) ±0.015 (0.38) unless otherwise specified.

ADVANCED: Data Sheets contain information regarding a product M/A-COM Technology Solutions is considering for development. Performance is based on target specifications, simulated results, and/or prototype measurements. Commitment to develop is not guaranteed.
PRELIMINARY: Data Sheets contain information regarding a product M/A-COM Technology Solutions has under development. Performance is based on engineering tests. Specifications are typical. Mechanical outline has been fixed. Engineering samples and/or test data may be available. Commitment to produce in volume is not guaranteed.

• **North America** Tel: 800.366.2266 • **Europe** Tel: +353.21.244.6400
 • **India** Tel: +91.80.4155721 • **China** Tel: +86.21.2407.1588
 Visit www.macontech.com for additional data sheets and product information.

M/A-COM Technology Solutions Inc. and its affiliates reserve the right to make changes to the product(s) or information contained herein without notice.