



**ELECTROSTATIC SENSITIVE DEVICE**  
OBSERVE HANDLING PRECAUTIONS

MITSUBISHI RF POWER MOS FET

# RD15HVF1

RoHS Compliance, Silicon MOSFET Power Transistor, 175MHz520MHz,15W

## DESCRIPTION

RD15HVF1 is a MOS FET type transistor specifically designed for VHF/UHF High power amplifiers applications.

## FEATURES

High power and High Gain:  
 $P_{out} > 15W$ ,  $G_p > 14dB$  @  $V_{dd} = 12.5V$ ,  $f = 175MHz$   
 $P_{out} > 15W$ ,  $G_p > 7dB$  @  $V_{dd} = 12.5V$ ,  $f = 520MHz$   
 High Efficiency: 60%typ. on VHF Band  
 High Efficiency: 55%typ. on UHF Band

## APPLICATION

For output stage of high power amplifiers in VHF/UHF Band mobile radio sets.

## RoHS COMPLIANT

RD15HVF1-101 is a RoHS compliant products. RoHS compliance is indicate by the letter "G" after the lot marking.

This product include the lead in high melting temperature type solders.

How ever,it applicable to the following exceptions of RoHS Directions.

- 1.Lead in high melting temperature type solders(i.e.tin-lead solder alloys containing more than85% lead.)

## OUTLINE DRAWING

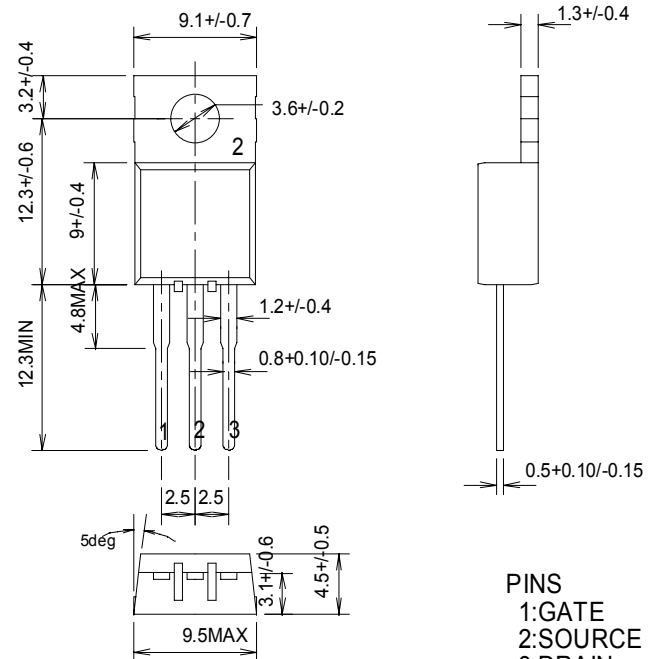

note:

Tolerance of no designation means typical value.  
Dimension in mm.

PINS  
 1:GATE  
 2:SOURCE  
 3:DRAIN



**ELECTROSTATIC SENSITIVE DEVICE**  
OBSERVE HANDLING PRECAUTIONS

MITSUBISHI RF POWER MOS FET

# RD15HVF1

RoHS Compliance, Silicon MOSFET Power Transistor, 175MHz520MHz,15W

## ABSOLUTE MAXIMUM RATINGS

(Tc=25°C UNLESS OTHERWISE NOTED)

SYMBOL	PARAMETER	CONDITIONS	RATINGS	UNIT
Vdss	Drain to source voltage	Vgs=0V	30	V
Vgss	Gate to source voltage	Vds=0V	+/-20	V
Pch	Channel dissipation	Tc=25°C	48	W
Pin	Input power	Zg=Zl=50Ω	1.5(Note2)	W
ID	Drain current	-	4	A
Tch	Channel temperature	-	150	°C
Tstg	Storage temperature	-	-40 to +150	°C
Rth j-c	Thermal resistance	junction to case	2.6	°C/W

Note 1: Above parameters are guaranteed independently.

Note 2: Over 300MHz use spec is 6W

## ELECTRICAL CHARACTERISTICS (Tc=25°C , UNLESS OTHERWISE NOTED)

SYMBOL	PARAMETER	CONDITIONS	LIMITS			UNIT
			MIN	TYP	MAX.	
Idss	Zero gate voltage drain current	Vds=17V, Vgs=0V	-	-	100	uA
Igss	Gate to source leak current	Vgs=10V, Vds=0V	-	-	1	uA
VTH	Gate threshold Voltage	Vds=12V, Ids=1mA	1.5	2.0	2.5	V
Pout1	Output power	VDD=12.5V, Pin=0.6W,	15	18	-	W
ηD1	Drain efficiency	f=175MHz, Idq=0.5A	55	60	-	%
Pout2	Output power	VDD=12.5V, Pin=3W,	15	18	-	W
ηD2	Drain efficiency	f=520MHz, Idq=0.5A	50	55	-	%
	Load VSWR tolerance	VDD=15.2V, Po=15W(PinControl) f=175MHz, Idq=0.5A, Zg=50Ω Load VSWR=20:1(All Phase)	No destroy			-
	Load VSWR tolerance	VDD=15.2V, Po=15W(PinControl) f=520MHz, Idq=0.5A, Zg=50Ω Load VSWR=20:1(All Phase)	No destroy			-

Note : Above parameters , ratings , limits and conditions are subject to change.



ELECTROSTATIC SENSITIVE DEVICE  
OBSERVE HANDLING PRECAUTIONS

MITSUBISHI RF POWER MOS FET

# RD15HVF1

RoHS Compliance, Silicon MOSFET Power Transistor, 175MHz520MHz,15W

## TYPICAL CHARACTERISTICS

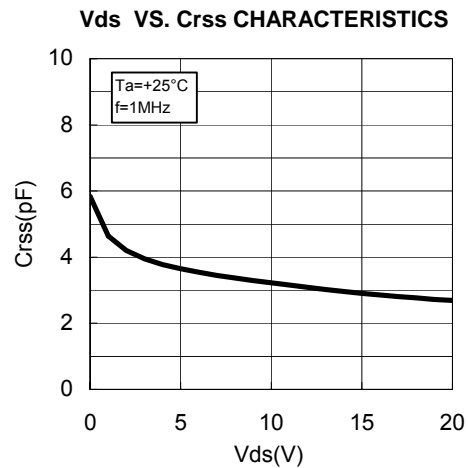
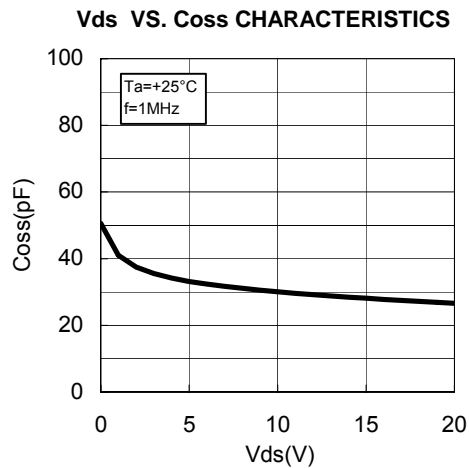
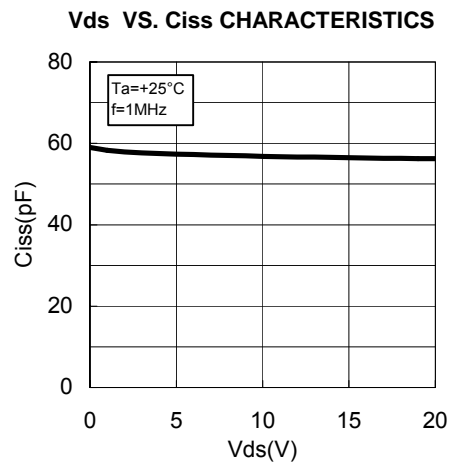
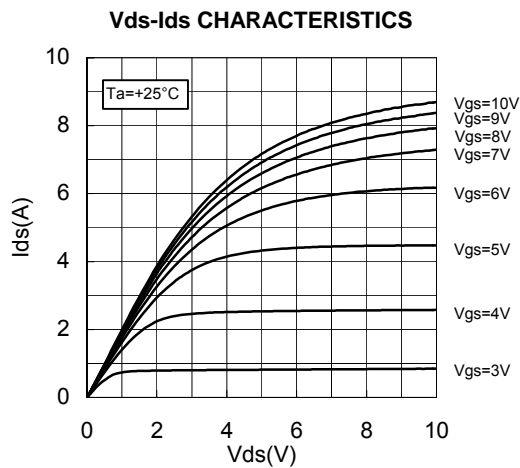
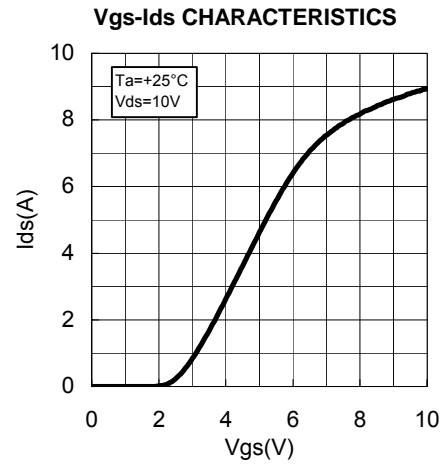
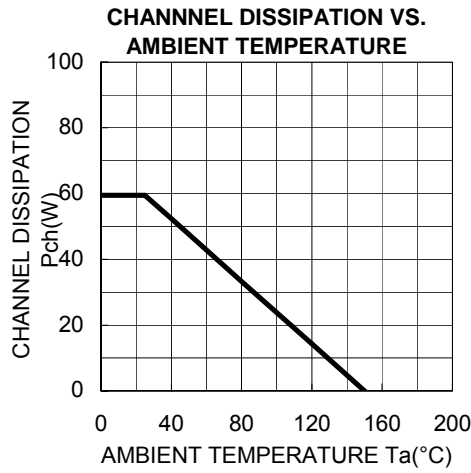



**ELECTROSTATIC SENSITIVE DEVICE**  
OBSERVE HANDLING PRECAUTIONS

MITSUBISHI RF POWER MOS FET

# RD15HVF1

RoHS Compliance, Silicon MOSFET Power Transistor, 175MHz520MHz,15W

## TYPICAL CHARACTERISTICS

**Pin-Po CHARACTERISTICS**

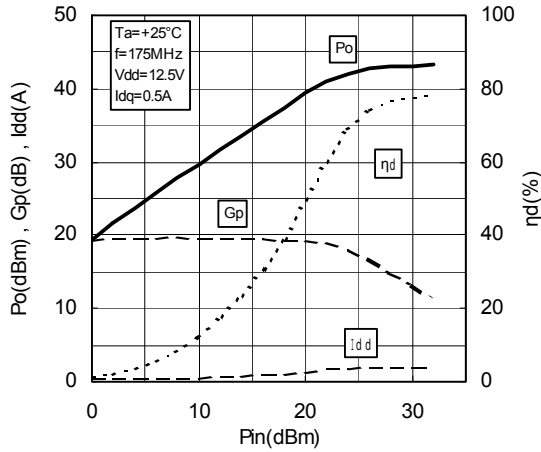

**Pin-Po CHARACTERISTICS**

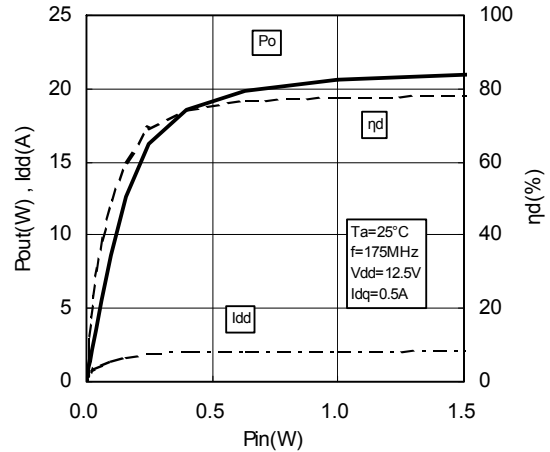

**Pin-Po CHARACTERISTICS**

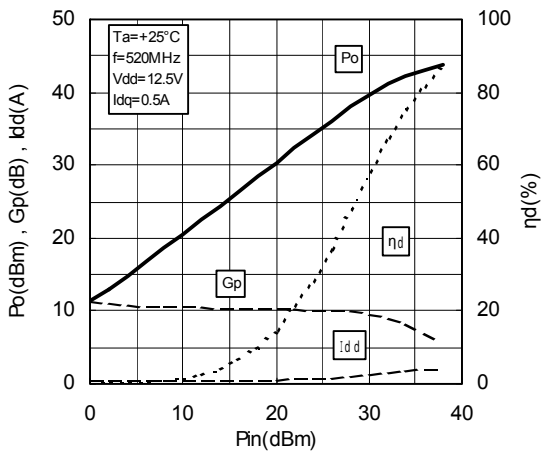

**Pin-Po CHARACTERISTICS**

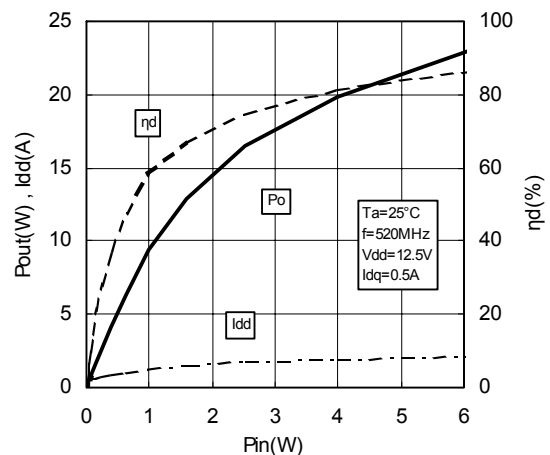

**Vdd-Po CHARACTERISTICS**

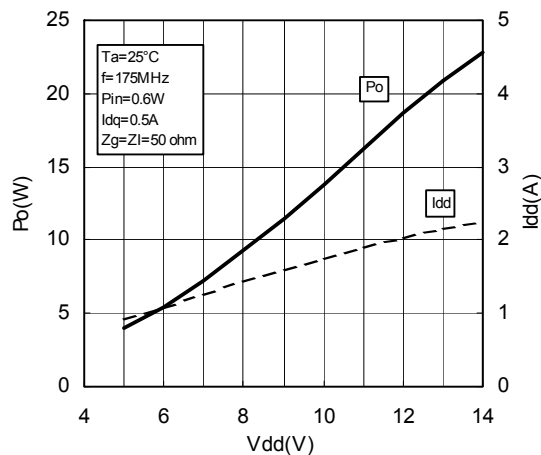

**Vdd-Po CHARACTERISTICS**

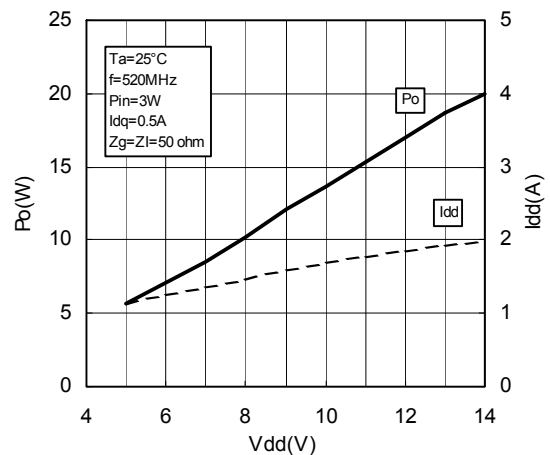



**ELECTROSTATIC SENSITIVE DEVICE**  
OBSERVE HANDLING PRECAUTIONS

MITSUBISHI RF POWER MOS FET

# RD15HVF1

RoHS Compliance, Silicon MOSFET Power Transistor, 175MHz~520MHz, 15W

## TYPICAL CHARACTERISTICS

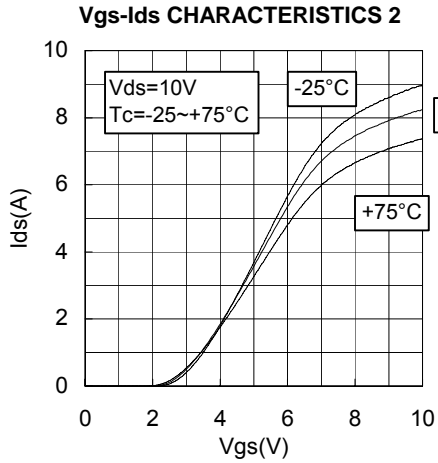

## TEST CIRCUIT(f=175MHz)

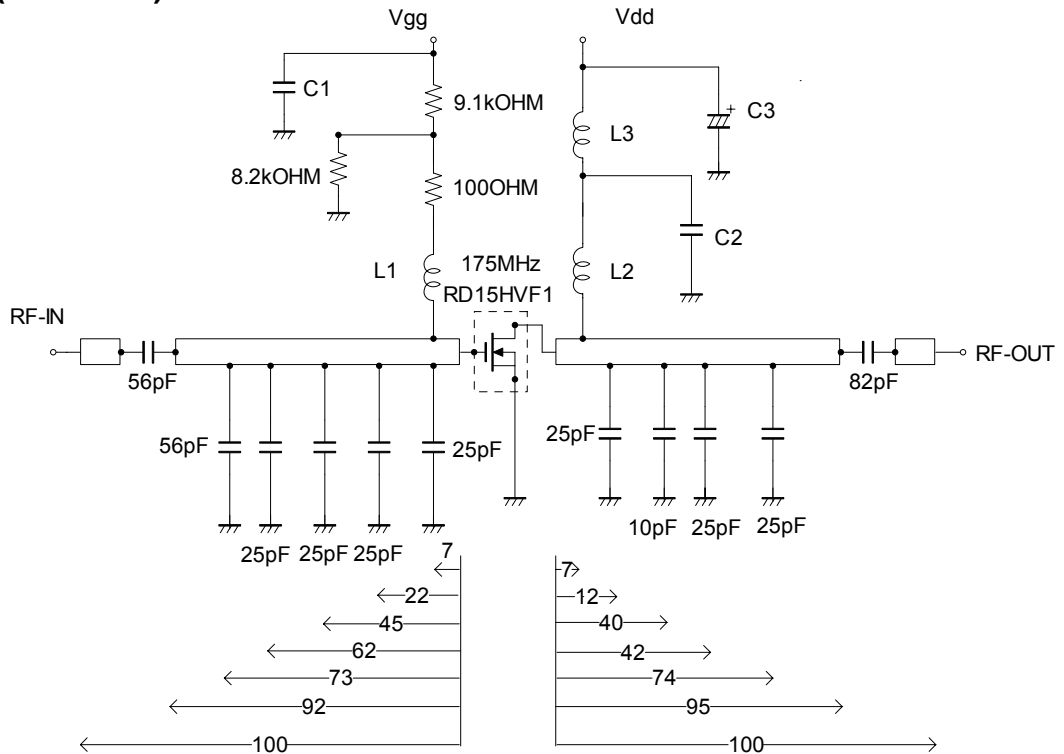

- C1:2200pF 10uF in parallel
- C2:2200pF\*2 in parallel
- C3:2200pF,330uF in parallel

- L1:4Turns,I.D6mm,D1.6mm P=1 silver plated copper wire
- L2:5Turns,I.D6mm,D1.6mm P=1 silver plated copper wire
- L3:4Turns,I.D6mm,D1.6mm P=1 silver plated copper wire

Note:Board material-Teflon substrate  
micro strip line width=4.2mm/50OHM,er:2.7,t=1.6mm

Dimensions:mm



**ELECTROSTATIC SENSITIVE DEVICE**  
OBSERVE HANDLING PRECAUTIONS

MITSUBISHI RF POWER MOS FET

# RD15HVF1

RoHS Compliance, Silicon MOSFET Power Transistor, 175MHz520MHz,15W

## TEST CIRCUIT(f=520MHz)

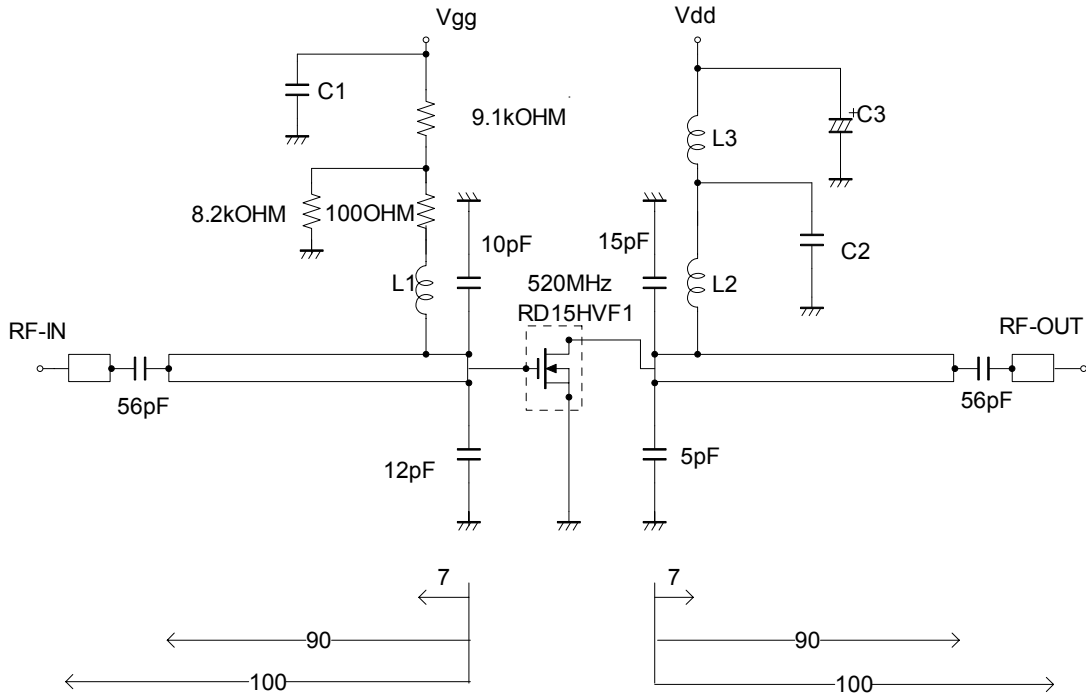

C1:2200pF 10uF in parallel

C2:2200pF\*2 in parallel

C3:2200pF,330uF in parallel

L1:4Turns,l.D6mm,D1.6mm P=1 silver plateted copper wire

L2:2Turns,l.D6mm,D1.6mm P=1 silver plateted copper wire

L3:4Turns,l.D6mm,D1.6mm P=1 silver plateted copper wire

Note:Board material-Teflon substrate

micro strip line width=4.2mm/50OHM,er:2.7,t=1.6mm

Dimensions:mm



**ELECTROSTATIC SENSITIVE DEVICE**  
OBSERVE HANDLING PRECAUTIONS

MITSUBISHI RF POWER MOS FET

**RD15HVF1**

RoHS Compliance, Silicon MOSFET Power Transistor, 175MHz520MHz,15W

**INPUT/OUTPUT IMPEDANCE VS.FREQUENCY CHARACTERISTICS**

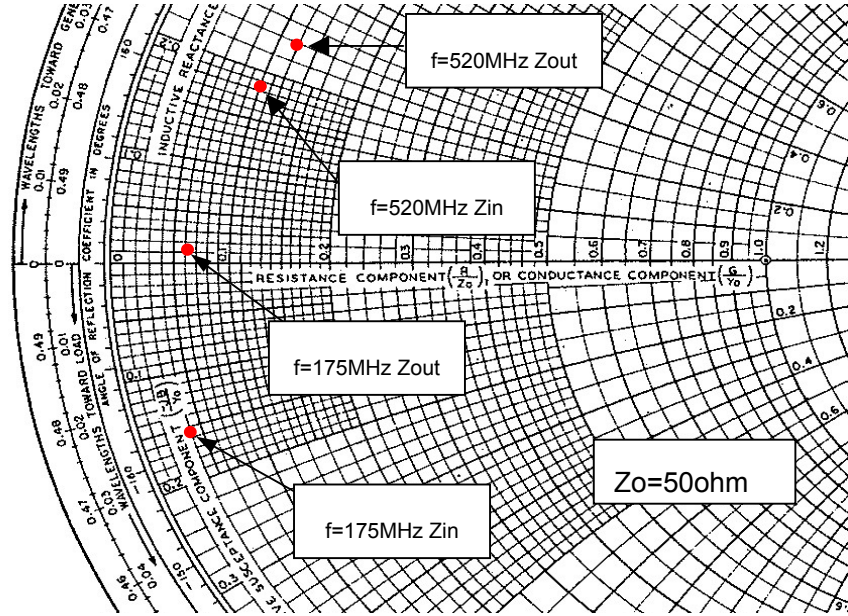

Zin , Zout

f (MHz)	Zin (ohm)	Zout (ohm)	Conditions
175	2.34-j8.01	3.06+j0.74	Po=15W, Vdd=12.5V, Pin=0.6W
520	5.42+j9.22	6.02+j12.34	Po=15W, Vdd=12.5V, Pin=3.0W



**ELECTROSTATIC SENSITIVE DEVICE**  
OBSERVE HANDLING PRECAUTIONS

**MITSUBISHI RF POWER MOS FET**

# RD15HVF1

**RoHS Compliance, Silicon MOSFET Power Transistor, 175MHz520MHz,15W**

RD15HVF1 S-PARAMETER DATA (@V<sub>dd</sub>=12.5V, I<sub>d</sub>=500mA)

Freq. [MHz]	S11		S21		S12		S22	
	(mag)	(ang)	(mag)	(ang)	(mag)	(ang)	(mag)	(ang)
50	0.717	-145.9	23.274	101.8	0.023	26.0	0.556	-130.2
100	0.726	-163.9	12.054	85.7	0.024	27.7	0.547	-150.4
150	0.744	-171.1	8.049	74.7	0.025	36.1	0.560	-157.8
175	0.748	-173.6	6.804	70.2	0.025	41.8	0.571	-160.1
200	0.755	-175.9	5.886	66.3	0.026	48.1	0.588	-161.8
250	0.770	-179.0	4.622	58.6	0.030	57.7	0.625	-164.3
300	0.787	177.6	3.731	51.5	0.036	65.3	0.647	-167.5
350	0.804	174.6	3.092	45.3	0.044	70.3	0.683	-170.9
400	0.821	171.2	2.623	39.1	0.053	73.5	0.716	-173.7
450	0.838	168.2	2.229	33.2	0.062	74.6	0.734	-176.8
500	0.849	165.1	1.938	28.3	0.072	73.9	0.765	179.4
520	0.854	163.7	1.845	26.1	0.076	73.9	0.777	178.0
550	0.862	161.7	1.695	22.9	0.082	72.6	0.788	176.3
800	0.900	145.0	0.971	4.2	0.135	62.8	0.859	159.0
850	0.904	141.3	0.864	0.0	0.143	59.6	0.870	155.7
900	0.909	137.9	0.790	-1.4	0.153	57.8	0.877	152.4
950	0.910	134.6	0.738	-4.4	0.163	54.8	0.880	149.0
1000	0.910	131.2	0.662	-6.8	0.170	51.4	0.886	145.7
1050	0.911	127.5	0.612	-8.4	0.178	49.4	0.892	142.1





**ELECTROSTATIC SENSITIVE DEVICE**  
OBSERVE HANDLING PRECAUTIONS

MITSUBISHI RF POWER MOS FET

# RD15HVF1

RoHS Compliance, Silicon MOSFET Power Transistor, 175MHz520MHz,15W

---

—————Keep safety first in your circuit designs! —————

Mitsubishi Electric Corporation puts the maximum effort into making semiconductor products better and more reliable, but there is always the possibility that trouble may occur with them. Trouble with semiconductors may lead to personal injury, fire or property damage. Remember to give due consideration to safety when making your circuit designs, with appropriate measures such as (i) placement of substitutive, auxiliary circuits, (ii) use of non-flammable material or (iii) prevention against any malfunction or mishap.

————— **warning !** —————

Do not use the device at the exceeded the maximum rating condition. In case of plastic molded devices, the exceeded maximum rating condition may cause blowout, smoldering or catch fire of the molding resin due to extreme short current flow between the drain and the source of the device. These results causes in fire or injury.