

CPDV5-5V0U

RoHS Device

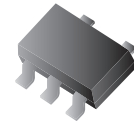

Features

- IEC61000-4-2 8kV(Contact), 15kV(air).
- Surface mount package.
- High component density.

Mechanical data

- Case: SOT-353 Standard package, molded plastic.
- Terminals: Gold plated, solderable per MIL-STD-750D, method 2026.
- Mounting position: Any.
- Weight: 0.0070 gram (approx.).

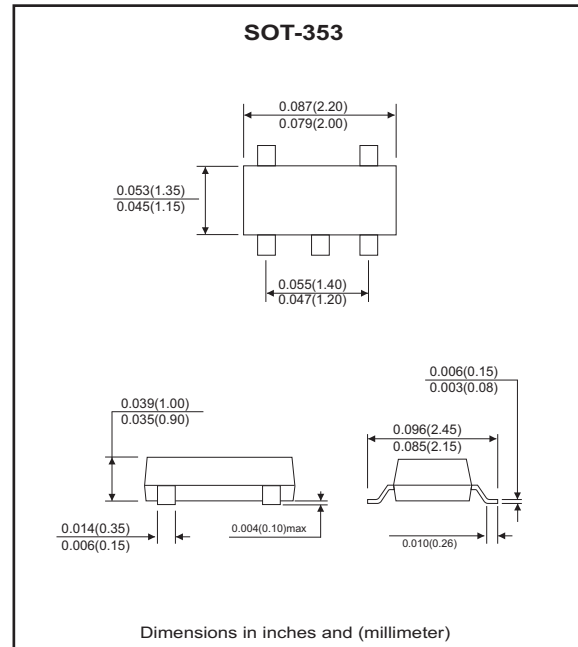

Marking: E5U

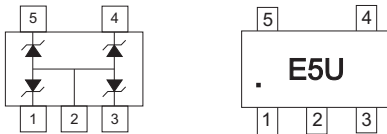

Maximum Rating and Electrical Characteristics (at TA=25°C unless otherwise noted)

Parameter	Symbol	Conditions	Min	Typ	Max	Unit
Diode breakdown voltage	V _{BD}	I _R = 1mA	6.1		7.1	V
Leakage current	I _L	V _R = 3V		0.1	1.0	uA
Forward voltage	V _F	I _F = 5uA			1.2	V
Junction capacitance	C _T	V _R = 0V, f = 1MHz		60	80	pF
Clamping voltage	V _C	I _{PP} = 1A, T _P =8/20us I _{PP} = 8A, T _P =8/20us			8 10	V
ESD capability	ESD	C = 150PF, R = 300ohm, forward and reverse 10 pulses	8			kV
Peak pulse power	P _{PP}				80	W
Operation temperature	T _J				125	°C
Storage temperature	T _{STG}		-55		150	°C

RATING AND CHARACTERISTIC CURVES (CPDV5-5V0U)

Fig. 1 - 8/20us Peak pulse current wave form acc. IEC 61000-4-5

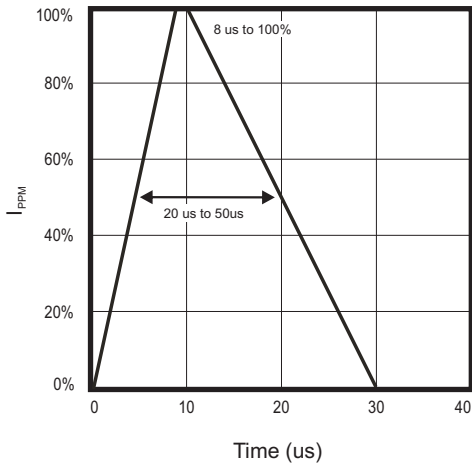

Fig. 2 - Power rating derating curve

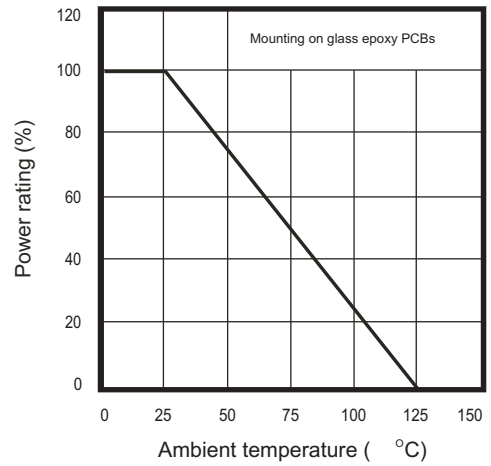

Fig. 3 - Clamping voltage vs. peak pulse current

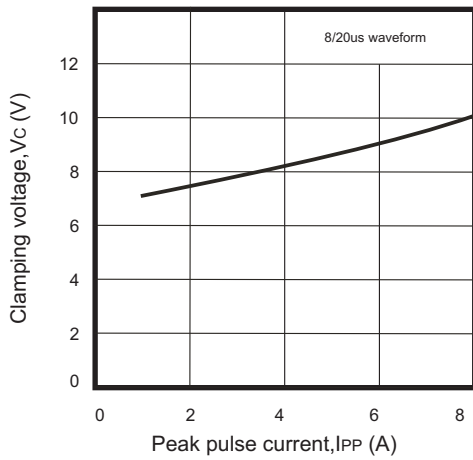
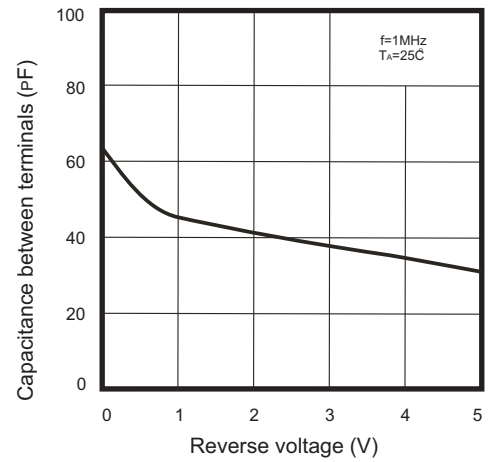
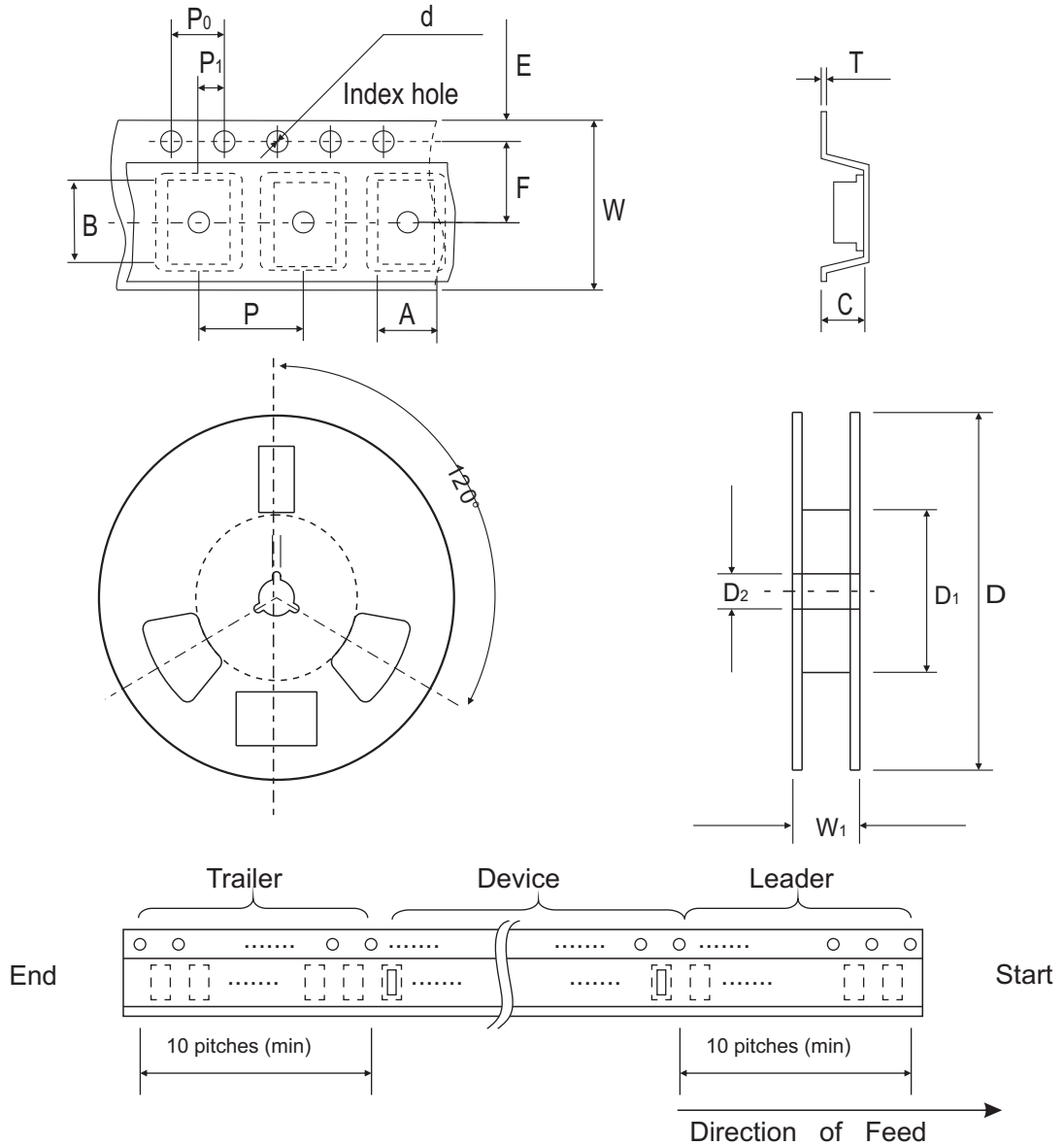

Fig. 4 - Capacitance between terminals characteristics



Reel Taping Specification



SOT-353	SYMBOL	A	B	C	d	D	D ₁	D ₂
	(mm)	2.20 ± 0.10	2.40 ± 0.10	1.35 ± 0.10	1.55 ± 0.10	178 ± 1	50.0 MIN.	13.0 ± 0.20
	(inch)	0.087 ± 0.004	0.094 ± 0.004	0.053 ± 0.004	0.061 ± 0.004	7.008 ± 0.040	1.969 MIN.	0.512 ± 0.008

SOT-353	SYMBOL	E	F	P	P ₀	P ₁	W	W ₁
	(mm)	1.75 ± 0.10	3.50 ± 0.05	4.00 ± 0.10	4.00 ± 0.10	2.00 ± 0.05	8.00 ± 0.30	14.4 MAX.
	(inch)	0.069 ± 0.004	0.138 ± 0.002	0.157 ± 0.004	0.157 ± 0.004	0.079 ± 0.002	0.315 ± 0.012	0.567 MAX.

Marking Code

Part Number	Marking Code
CPDV5-5V0U	E5U

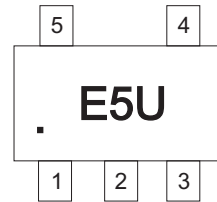

Suggested PAD Layout

SIZE	SOT-353	
	(mm)	(inch)
A	0.80	0.031
B	0.35	0.014
C	1.30	0.051
D	1.94	0.076
E	2.74	0.108

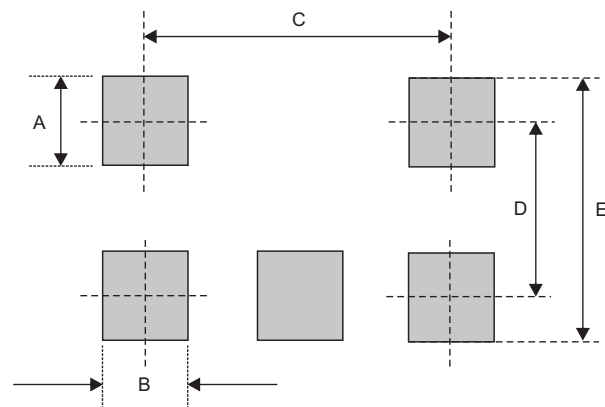

Standard Package

Case Type	Qty per Reel	Reel Size
	(Pcs)	(inch)
SOT-353	3000	7