



Spec. No.	PS-ND-0711
Rev.	A

PRODUCT SPECIFICATION

Model No : CSS-1014G/1015G

Descriptions:

- 1.0 Inch Single Digit Display
- Emitting Color : Yellow Green



CUSTOMER APPROVED	APPROVED BY	CHECKED BY	PREPARED BY
SIGNATURES			陳新強

CHINA SEMICONDUCTOR CORPORATION
Address:2FL. NO.909,Chung-Cheng Road,
Chung-Ho City Taipei Hsien,Taiwan.

Tel:886-2-2223-9696
Fax:886-2-2223-9377

OPTO PLUS TECHNOLOGIES CO.,LTD
Address:696 Shun jiang Rd.,Ji Shan St.Shaoxing,
ZheJiang,China

Tel:86-0575-88623888
Fax:86-0575-88623112



Spec. No.	PS-ND-0711
Rev.	A

Model No : CSS-1014G/1015G

Features -

1. 1.0 inch (25.4mm) digit height.
2. Case mold type.
3. RoHS compliant.
4. Low power consumption.
5. Easy mounting on P.C. board or socket.

Device Selection Guide -

Model No.	Chip		Description
	Material	Emitted Color	
CSS-1014G	GaP	Yellow Green	Common Anode
CSS-1015G	GaP	Yellow Green	Common Cathode

Mechanical Dimensions -

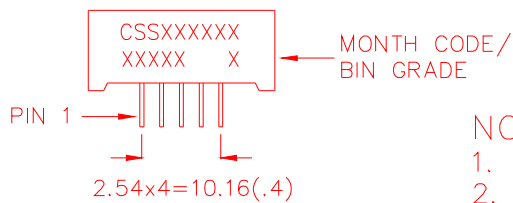
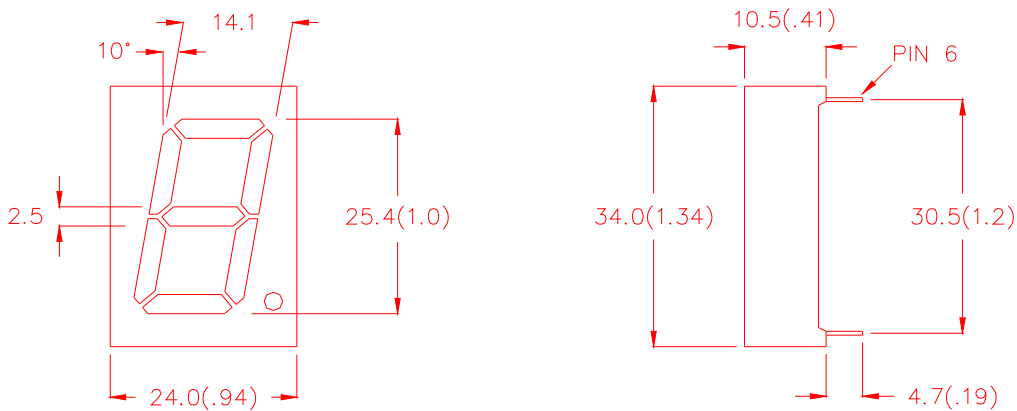

NOTE:

1. All pins are $\phi 0.5(.02)$.
2. Dimension in millimeter (inch), and tolerance is $\pm 0.25 (.01)$ unless otherwise noted.



Model No : CSS-1014G/1015G

Internal Circuit Diagrams -

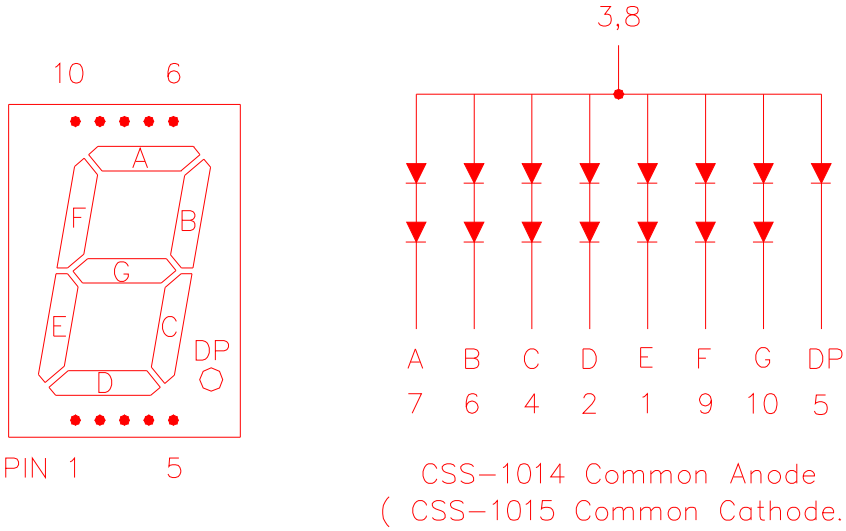

Absolute Maximum Rating -

(Ta=25°C)

Parameter	Symbol	Rating	Unit
Power Dissipation Per Dice	Pd	70	mW
Continuous Forward Current Per Dice	IAF	25	mA
Peak Current Per Dice	IPF	90	mA
Continuous Forward Current Per Dice	-	0.33	mA/°C
Reverse Voltage Per Dice	VR	5	V
Operating Temperature	Topr	-35 ~ +85	°C
Storage Temperature	Tstg	-35 ~ +85	°C
Solder temperature 1/16 inch below seating plane for 3 seconds at 260 °C			



Model No : CSS-1014G/1015G

■ **Electro-optical Characteristics -**

(Ta=25°C)

Parameter	Symbol	Min.	Typ.	Max.	Unit	Condition
Forward Voltage Per Segment(DP)	VF	-	4.2(2.1)	5.6(2.8)	V	IF=20mA
Luminous Intensity Per Segment	Iv	-	10	-	mcd	IF=10mA
Peak Emission Wavelength	λP	-	568	-	nm	IF=20mA
Dominant Wavelength	λd	-	572	-	nm	IF=20mA
Spectrum Radiation Bandwidth	$\Delta \lambda$	-	30	-	nm	IF=20mA
Reverse Current	IR	-	-	100	μA	VR=5V
Luminous Intensity Matching Ratio	IV-m	-	-	2:1	-	IF=20mA



Model No : CSS-1014G/1015G

■ Typical Electrical / Optical Characteristics Curves -

(Ta = 25°C Unless Otherwise Noted)

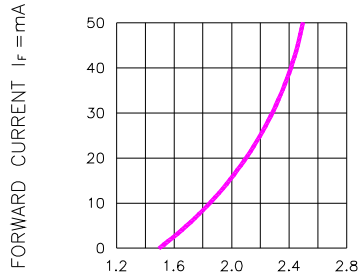

Fig.1 FORWARD CURRENT VS. FORWARD VOLTAGE

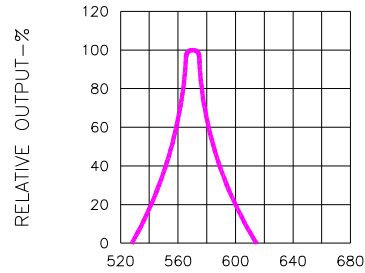

Fig.2 SPECTRAL RESPONSE

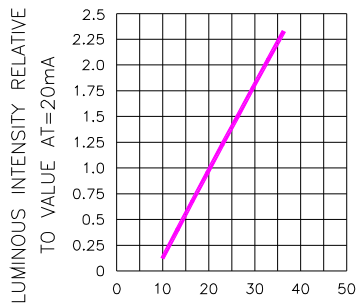

Fig.3 RELATIVE LUMINOUS INTENSITY VS. FORWARD CURRENT

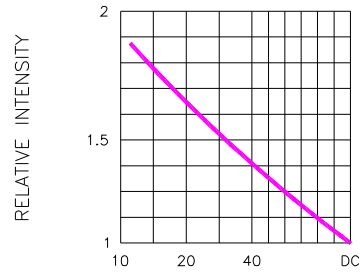

Fig.5 LUMINOUS INTENSITY VS. DUTY CYCLE

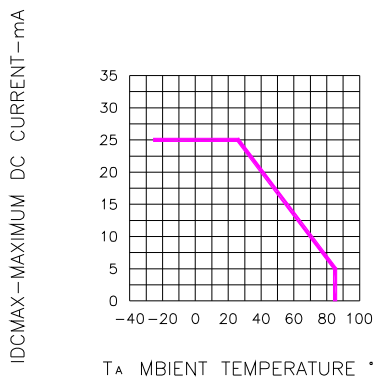

Fig.4 MAXIMUM ALLOWABLE DC CURRENT PER SEGMENT VS. A FUNCTION OF AMBIENT TEMPERATURE

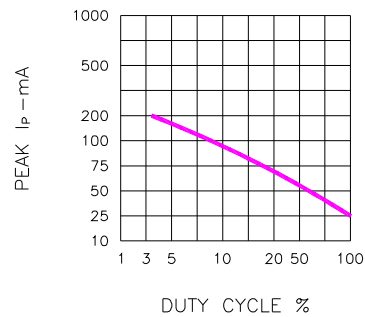

Fig.6 MAX PEAK CURRENT VS. DUTY CYCLE % (REFRESH RATE f=1 KHz)



Spec. No.	PS-ND-0711
Rev.	A

Model No : CSS-1014G/1015G

■ Package Dimensions

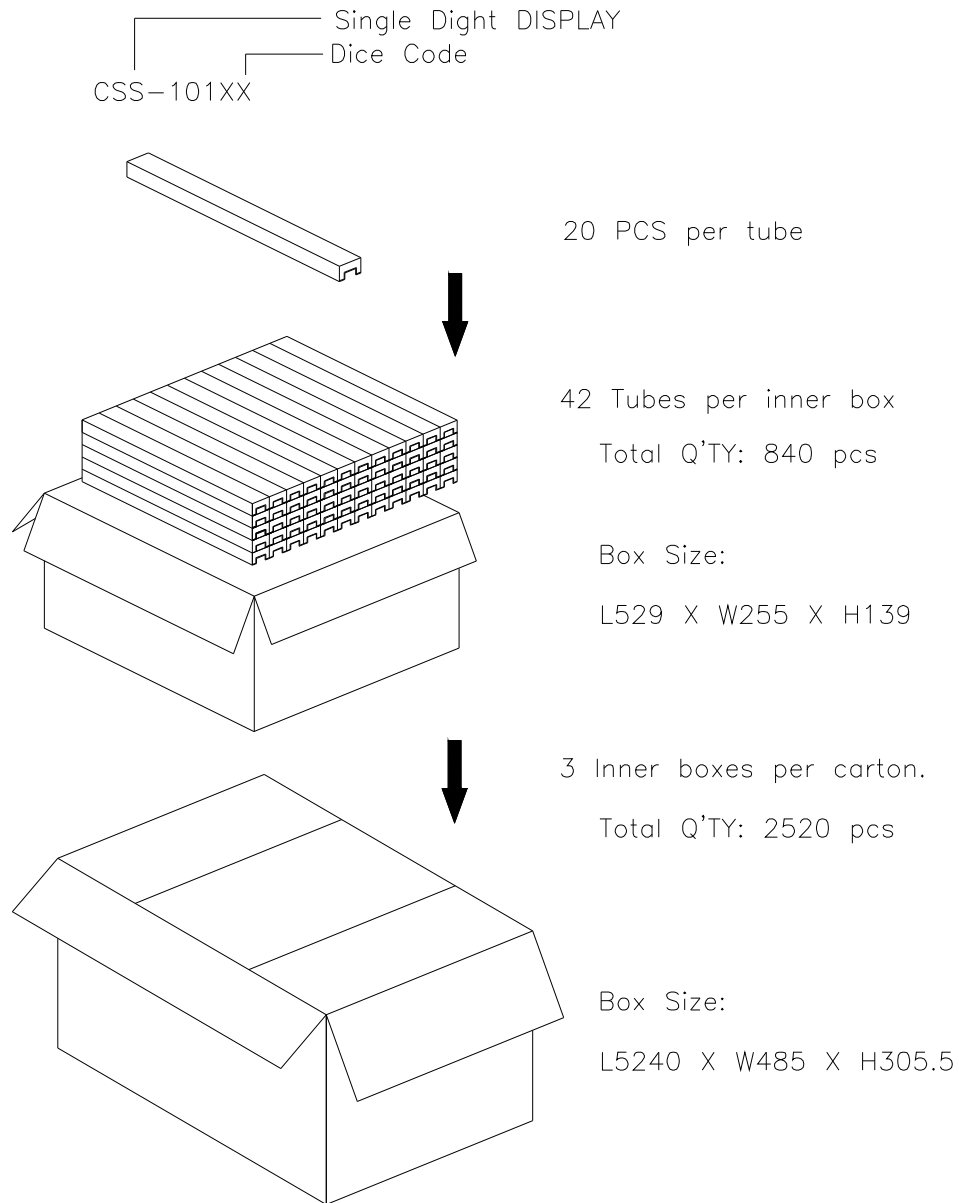

Note: The specifications are subject to change without notice. Please contact us for updated information
<http://www.csctw.com.tw>