



Spec. No.	PS-ND-0807
Rev.	A

PRODUCT SPECIFICATION

Model No : CSS-392V9/393V9

Descriptions:

- 0.39 Inch Single Digit Display
- Emitting Color : Super Bright Orange



CUSTOMER APPROVED	APPROVED BY	CHECKED BY	PREPARED BY
SIGNATURES			陳新強

CHINA SEMICONDUCTOR CORPORATION
Address:2FL. NO.909,Chung-Cheng Road,
Chung-Ho City Taipei Hsien,Taiwan.

Tel:886-2-2223-9696
Fax:886-2-2223-9377

OPTO PLUS TECHNOLOGIES CO.,LTD
Address:696 Shun jiang Rd.,Ji Shan St.Shaoxing,
ZheJiang,China

Tel:86-0575-88623888
Fax:86-0575-88623112



Model No : CSS-392V9/393V9

Features -

1. 0.39 inch (10.0mm) digit height.
2. Case mold type.
3. RoHs compliant.
4. Low power consumption.
5. Easy mounting on P.C. board or socket.

Device Selection Guide -

Model No.	Chip		Description
	Material	Emitted Color	
CSS-392V9	AlGaInP	Super Bright Orange	Common Anode
CSS-393V9	AlGaInP	Super Bright Orange	Common Cathode

Mechanical Dimensions -

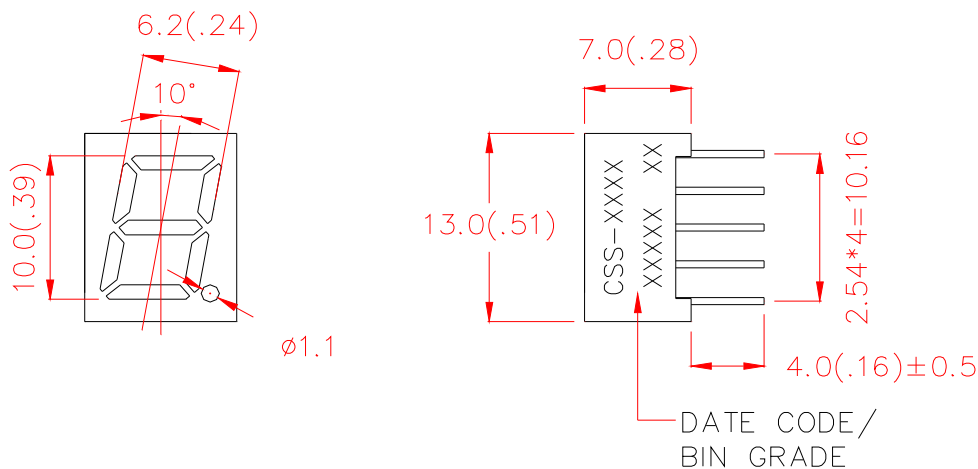

NOTE:

1. All pin are $\phi 0.51$.
2. All dimensions in millimeter, and tolerance is ± 0.25 (.01) unless otherwise noted.



Model No : CSS-392V9/393V9

Internal Circuit Diagrams -

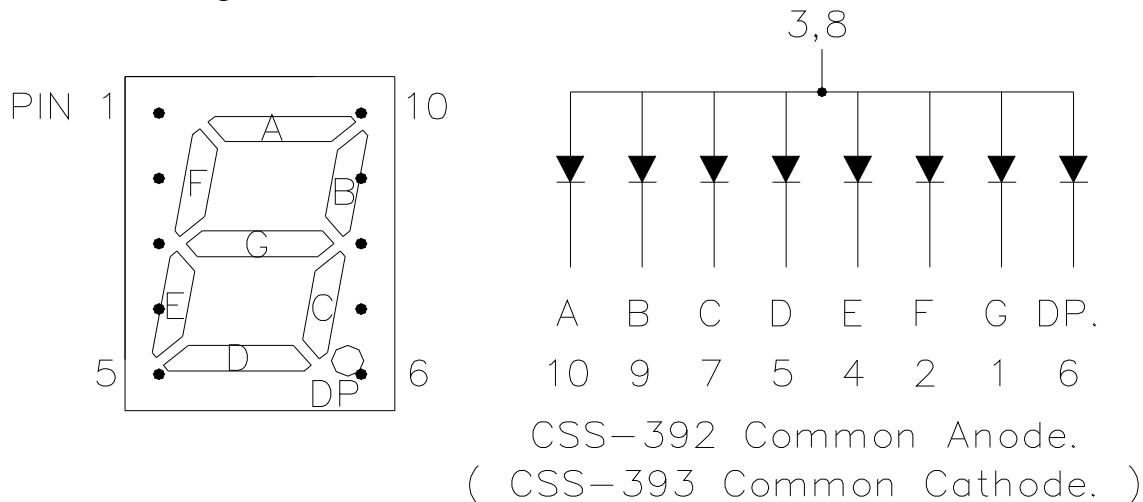

Absolute Maximum Rating -

(Ta=25°C)

Parameter	Symbol	Rating	Unit
Power Dissipation Per Dice	Pd	70	mW
Continuous Forward Current Per Dice	IAF	25	mA
Peak Current Per Dice	IPF	90	mA
Continuous Forward Current Per Dice	-	0.33	mA/°C
Reverse Voltage Per Dice	VR	5	V
Operating Temperature	Topr	-35 ~ +85	°C
Storage Temperature	Tstg	-35 ~ +85	°C
Solder temperature 1/16 inch below seating plane for 3 seconds at 260 °C			



Model No : CSS-392V9/393V9

■ Electro-optical Characteristics -

(Ta=25°C)

Parameter	Symbol	Min.	Typ.	Max.	Unit	Condition
Forward Voltage Per Segment	V _F	-	2.0	2.8	V	I _F =20mA
Luminous Intensity Per Segment	I _v	4800	12000	-	ucd	I _F =10mA
Peak Emission Wavelength	λ _P	-	632	-	nm	I _F =20mA
Dominant Wavelength	λ _d	-	624	-	nm	I _F =20mA
Spectrum Radiation Bandwidth	Δλ	-	20	-	nm	I _F =20mA
Reverse Current	I _R	-	-	100	μA	V _R =5V
Luminous Intensity Matching Ratio	I _V -m	-	-	2:1	-	I _F =10mA



Spec. No.	PS-ND-0807
Rev.	A

Model No : CSS-392V9/393V9

■ Typical Electrical / Optical Characteristics Curves -

(Ta = 25°C Unless Otherwise Noted)

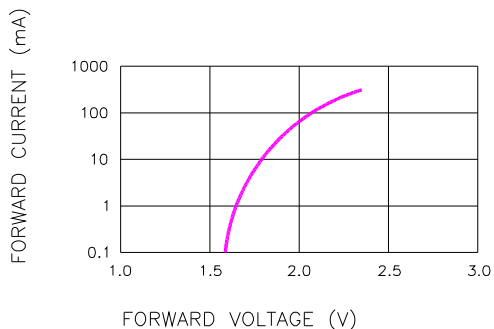

Fig.1 FORWARD CURRENT VS. FORWARD VOLTAGE

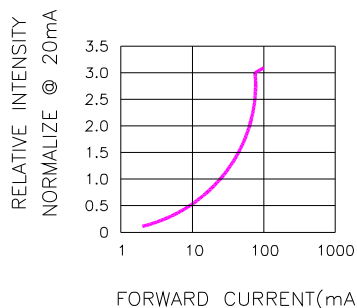

Fig.2 RELATIVE INTENSITY VS. FORWARD CURRENT

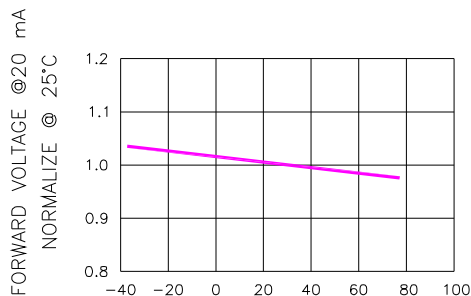

Fig.3 FORWARD VOLTAGE VS. TEMPERATURE

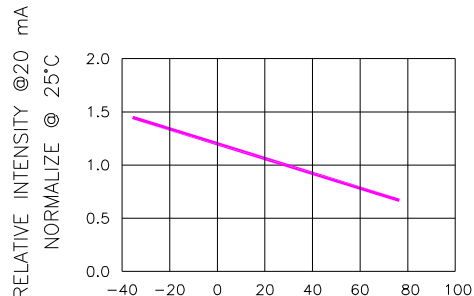

Fig.4 RELATIVE INTENSITY VS. TEMPERATURE

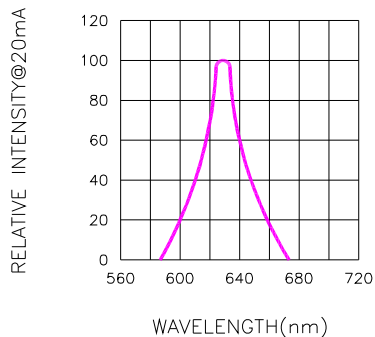

Fig.5 RELATIVE INTENSITY VS. WAVELENGTH



Spec. No.	PS-ND-0807
Rev.	A

Model No: **CSS-392V9/393V9**

■ Package Dimensions

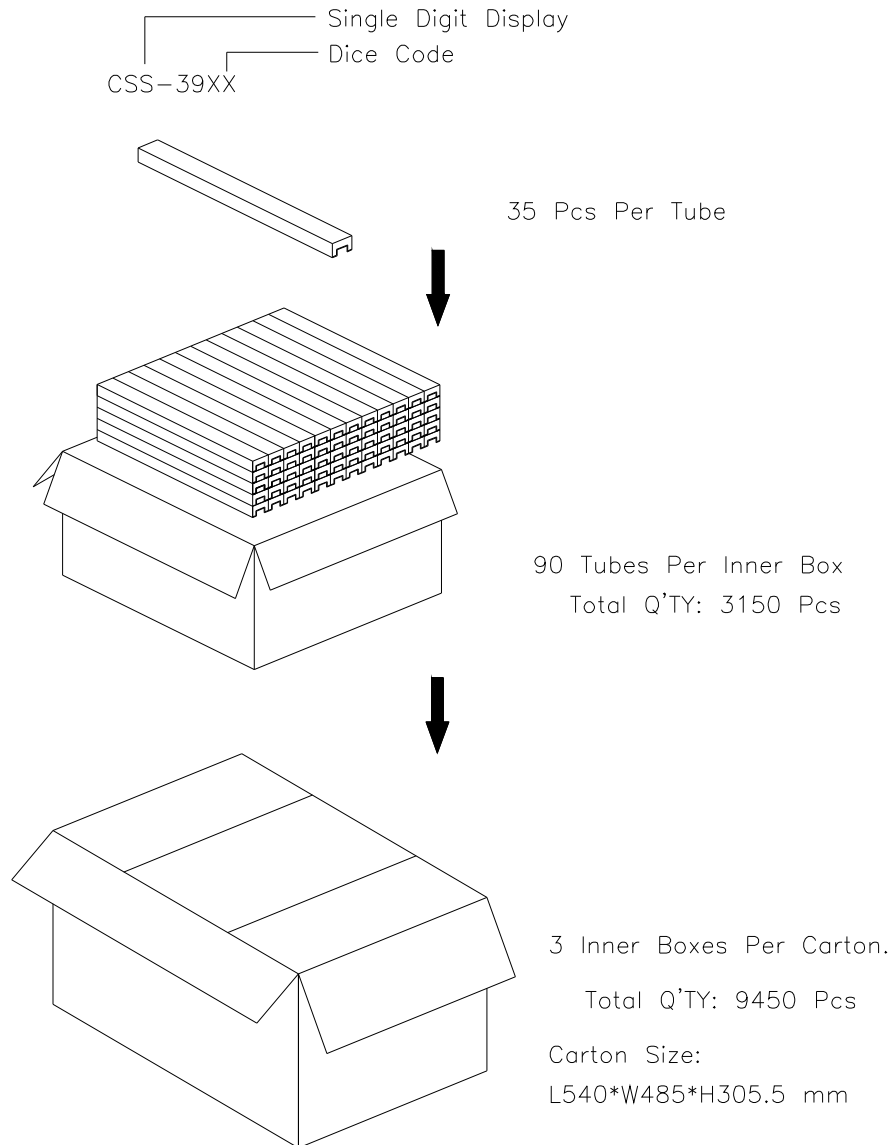

Note: The specifications are subject to change without notice. Please contact us for updated information.
<http://www.csctw.com.tw>