

406596354

SUPPLY VOLTAGE, +V _S to -V _S	PA241CE	PA241DF
OUTPUT CURRENT, continuous within SOA	PA241CEA	PA241DFA
OUTPUT CURRENT, peak	7	7
POWER DISSIPATION, continuous @ T _C \$	60 mA	60 mA
INPUT VOLTAGE, differential	120 mA	120 mA
INPUT VOLTAGE, common mode	8	8
TEMPERATURE, junction ²	-16 V	-16 V
	-V _S	-V _S
	\$	\$
	\$	\$
	mUP\$	mUP\$
	mUP\$	mUP\$

4154

PARAMETER	TEST CONDITIONS ¹	PA241CE, PA241DF			PA241CEA			UNITS
		MIN	TYP	MAX	MIN	TYP	MAX	
INPUT								
OFFSET VOLTAGE, vs. temperature ³	UP\$							N7
OFFSET VOLTAGE, vs. temperature ³	UP\$							7\$
BIAS CURRENT, initial ⁶								7\$
OFFSET CURRENT, initial ⁶								77
INPUT IMPEDANCE, DC			10 ¹¹					7L
COMMON MODE, voltage range		+V _S m						Q"
COMMON MODE, voltage range		-V _S						Q7
COMMON MODE REJECTION, DC	V _{CM} 7%\$							Q"
NOISE, broad band	10kHz BW, R _S ,							Q'
GAIN	3 _L = ,							7
OUTPUT VOLTAGE SWING	I _O = 40mA	-V _S 12	-V _S 10		-V _S 10	-V _S m		7
CURRENT, peak ⁴								E#
SETTLING TIME to .1%	10V step, A _V m							73.4
SLEW RATE	C _C Q'							7QQ
RESISTANCE , 1mA	R _{CL} =							Q'
RESISTANCE , 40 mA	R _{CL}							7
POWER SUPPLY								E#
THERMAL								.)
PA241CE RESISTANCE, AC junction to case	F > 6)[L)
PA241DF RESISTANCE, AC junction to case	F > 6)[V
PA241CE RESISTANCE, DC junction to case	F < 6)[N"
PA241DF RESISTANCE, DC junction to case	F < 6)[N"
PA241DF RESISTANCE, junction to air ⁷	VMMUFNQFSBUVSFSBOHF							T

1. Unless otherwise noted T_C \$ c = 6.8pF. DC input specifications are – value given. Power supply voltage is typical rating.
2. Long term operation at the maximum junction temperature will result in reduced product life. Derate internal power dissipation to achieve high MTTF. For guidance, refer to heatsink data sheet.
3. Guaranteed but not tested.
4. Rating applies with solder connection of heatslug to a minimum 1 square inch foil area of the printed circuit board.

The PA241 is constructed from MOSFET transistors. ESD handling procedures must be observed.

#0-685.374

SUPPLY VOLTAGE, +V _S to -V _S	PA241DW
OUTPUT CURRENT, continuous within SOA	PA241DWA
OUTPUT CURRENT, peak	7
POWER DISSIPATION, continuous @ T _C	60 mA
INPUT VOLTAGE, differential	120 mA
INPUT VOLTAGE, common mode	8
TEMPERATURE, junction ²	-16 V
	-V _S
	\$
	\$
	mUP\$
	mUP\$

4184

PARAMETER	TEST CONDITIONS ¹	MIN	PA241DW TYP	MAX	MIN	PA241DWA TYP	MAX	UNITS
INPUT								
OFFSET VOLTAGE, vs. temperature ³	UP\$							N7
OFFSET VOLTAGE, vs. temperature ³	UP\$							7\$
BIAS CURRENT, initial			100	2000				7\$
INPUT IMPEDANCE, DC			10 ¹¹					77
COMMON MODE, voltage range		+V _S m						7LI
COMMON MODE, voltage range		-V _S						Q"
COMMON MODE REJECTION, DC	V _{CM} 7%\$							Q7
NOISE, broad band	10kHz BW, R _S ,							Q"
GAIN	3 _L = ,							Q'
OUTPUT VOLTAGE SWING	I _O = 40mA	-V _S 12	-V _S 10		-V _S 10	-V _S m		7
CURRENT, peak ⁴	10V step, A _V m							7
SETTLING TIME to .1%	C _C Q'							E#
SLEW RATE	R _{CL} =							73.4
RESISTANCE , 1mA	R _{CL}							7QQ
RESISTANCE , 40 mA								7QQ
POWER SUPPLY								
THERMAL								
PA241DW RESISTANCE, AC junction to case	F > 6)[Q'
PA241DW RESISTANCE, DC junction to case	F < 6)[7
								N"

- Unless otherwise noted T_C = 25°C. DC input specifications are – value given. Power supply voltage is typical rating.
- Long term operation at the maximum junction temperature will result in reduced product life. Derate internal power dissipation to achieve high MTTF. For guidance, refer to heatsink data sheet.
- Guaranteed but not tested.
- Must be added to the values given for total output resistance.

The PA241 is constructed from MOSFET transistors. ESD handling procedures must be observed.

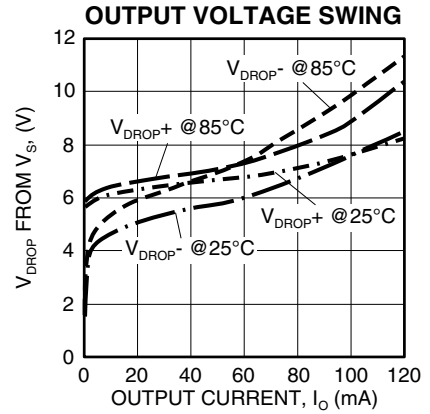
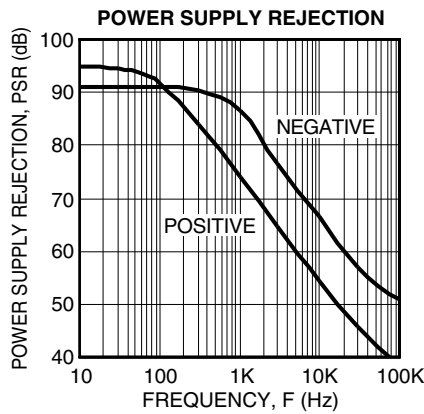
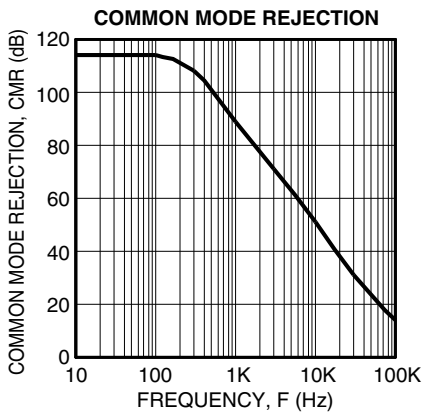
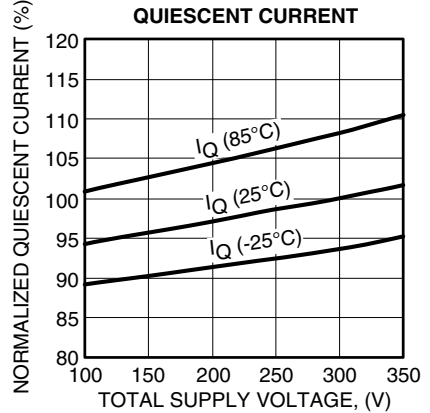
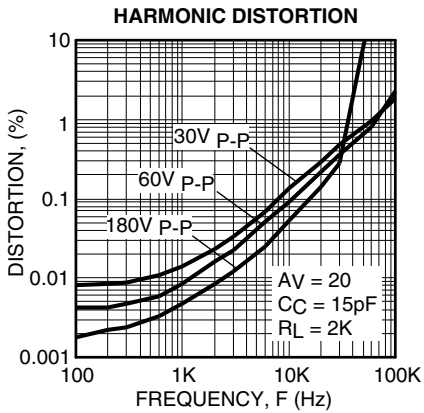
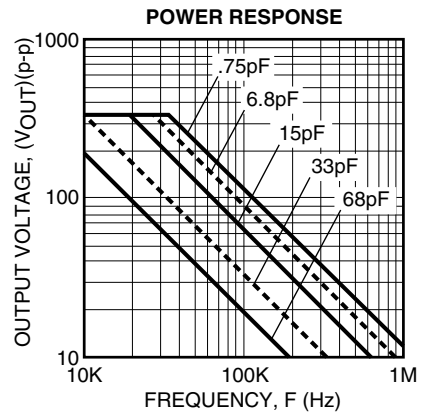
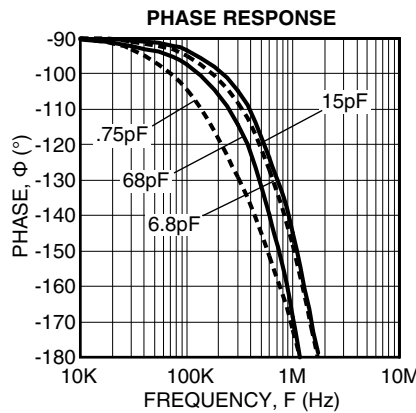
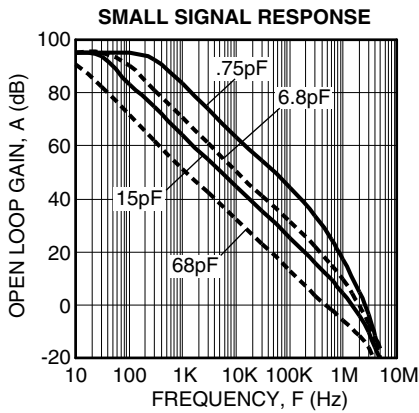
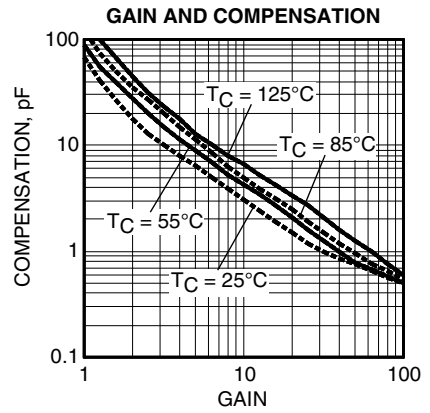
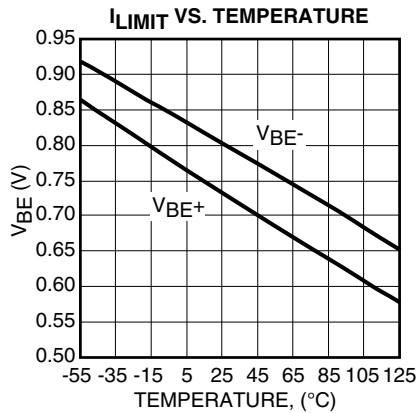
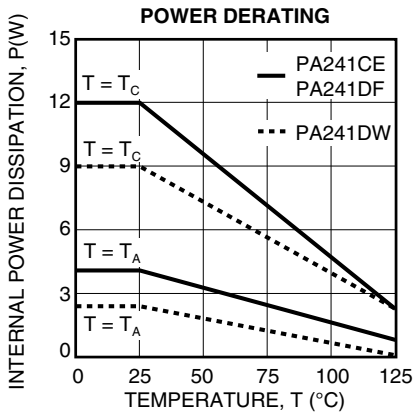

3

1) **4.1.15/**
 Open loop gain and phase shift both increase with increasing temperature. The PHASE COMPENSATION typical graph shows closed loop gain and phase compensation capacitor value relationships for four case temperatures. The curves are CBTFEPOBDIJFWJOHBOIBTFNBESHJOPCBMDVMBUFUIFIJHI-est case temperature for the application (maximum ambient temperature and highest internal power dissipation) before choosing the compensation. Keep in mind that when working with small values of compensation, parasitics may play a large role in performance of the finished circuit. The compensation capacitor must be rated for at least the total voltage applied to the amplifier and should be a temperature stable type such as NPO or COG.

1) **4.1.15/**

Open loop gain and phase shift both increase with increasing temperature. The PHASE COMPENSATION typical graph shows closed loop gain and phase compensation capacitor value relationships for four case temperatures. The curves are CBTFEPOBDIJFWJOHBOIBTFNBESHJOPCBMDVMBUFUIFIJHI-est case temperature for the application (maximum ambient temperature and highest internal power dissipation) before choosing the compensation. Keep in mind that when working with small values of compensation, parasitics may play a large role in performance of the finished circuit. The compensation capacitor must be rated for at least the total voltage applied to the amplifier and should be a temperature stable type such as NPO or COG.

0) **4.1.14**

There are two important concepts about closed loop gain when choosing compensation. They stem from the fact that the feedback factor is really what counts when designing for stability.

1. Gain must be calculated as a non-inverting circuit (equal input and feedback resistors can provide a signal gain of -1, but for calculating offset errors, noise, and stability, this is a gain of 2).
2. Including a feedback capacitor changes the feedback factor or gain of the circuit. Consider Rin=4.7k, Rf=47k for a gain of 11. Compensation of 4.7 to 6.8pF would be reasonable. Adding 33pF parallel to the 47k rolls off the circuit at 103kHz, BOEUB.) [BTSFEVD FEHBJOGSPNUPSPVHMZBOE the circuit is likely to oscillate.

As a general rule the DC summing junction impedance (parallel combination of the feedback resistor and all input SFTJTUPSTTIPVMECFMJNJUFEUPLPINTPSMFTTFFBNQMJS input capacitance of about 6pF, plus capacitance of connecting traces or wires and (if used) a socket will cause undesirable circuit performance and even oscillation if these resistances are too high. In circuits requiring high resistances, measure or FTUJNBUIFUPUBMTVNQJOUDBQBDJUBODFNVMUJQMZCZJG3GBOE parallel Rf with this value. Capacitors included for this purpose are usually in the single digit pF range. This technique results in equal feedback factor calculations for AC and DC cases. It does not produce a roll off, but merely keeps β constant over BXEFGSFRVFODZSBOHF1BSBHSBQIPGQQMJDBUJPOPUF details suitable stability tests for the finished circuit.

6) **3.3.5**

For proper operation, the current limit resistor, Rcl, must be connected as shown in the external connection diagram. The NJOJNVNWBMVFJT PINTIPKWFSGPSPQUJNVNSFMJBCJMJUZ the resistor should be set as high as possible. The maximum practical value is 110 ohms. Current limit values can be predicted as follows:

$$I_{limit} = \frac{V_{be}}{R_{cl}}$$

Where Vbe is shown in the CURRENT LIMIT typical graph.

Note that +Vbe should be used to predict current through the +Vs pin, -Vbe for current through the -Vs pin, and that they vary with case temperature. Value of the current limit resistor BUDBDTFUFNQFSBUVSFPGDBOCFFTUJNBUEBTGPMPX

$$R_{cl} = \frac{0.7}{I_{limit}}$$

When the amplifier is current limiting, there may be spurious oscillation present during the current limited portion of the negative half cycle. The frequency of the oscillation is not predictable and depends on the compensation, gain of the amplifier, value of the current limit resistor, and the load. The oscillation will cease as the amplifier comes out of current limit.

4) **0.1.3.3**

The MOSFET output stage of the PA241 is not limited by second breakdown considerations as in bipolar output stages. However there are still three distinct limitations:

1. Voltage withstand capability of the transistors.
2. Current handling capability of the die metalization.
3. Temperature of the output MOSFETS.

These limitations can be seen in the SOA (see Safe Operating Area graphs). Note that each pulse capability line shows a constant power level (unlike second breakdown limitations where power varies with voltage stress). These lines are shown GPSBDBTFUFNQFSBUVSFPGBOE DPSSFTQPOEUPUIFSNBM SFTJTUBODFTPGGPSUIFBOE%BOE for the PA241DW respectively. Pulse stress levels for other case temperatures can be calculated in the same manner as DC power levels at different temperatures. The output stage is protected against transient yback by the parasitic diodes of the output stage MOSFET structure. However, for protection against sustained high energy yback external fast-recovery diodes must be used.

5) **7**

The PA241DF package has a large exposed integrated copper heatslug to which the monolithic amplifier is directly attached. The solder connection of the heatslug to a minimum of 1 square inch foil area on the printed circuit board will result JOUIFSNBMQFSGPSNBODFPKGKVODUJPOUPBJSSBUJOHPGUIF PA241DF. Solder connection to an area of 1 to 2 square inches is recommended. This may be adequate heatsinking but the large number of variables involved suggest temperature measurements be made on the top of the package. Do not allow UIFUFNQFSBUVSFUPFYDFFE\$

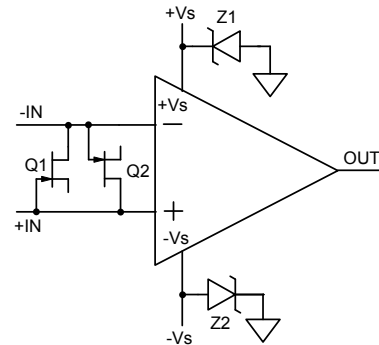
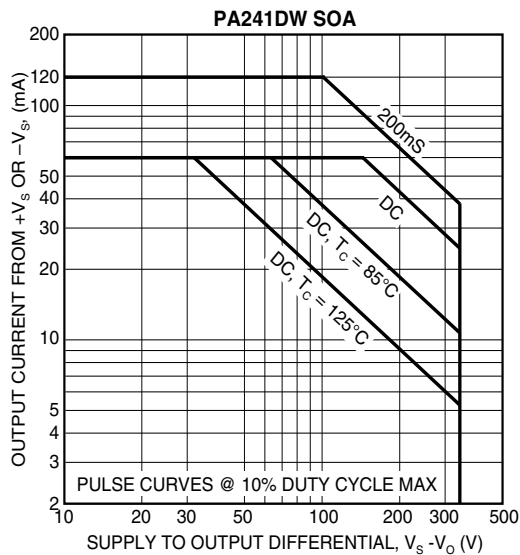
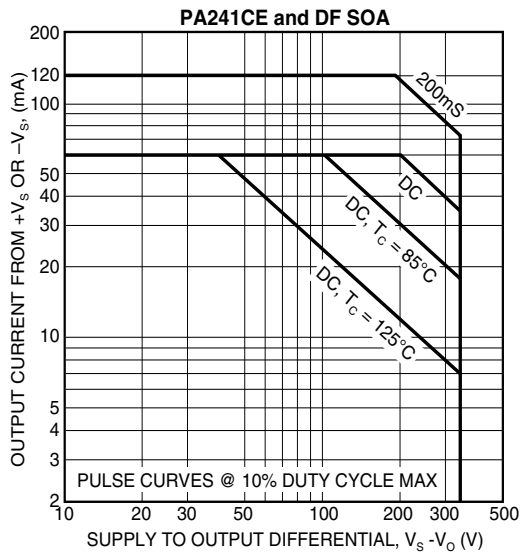

FIGURE 1

OVERLOAD

Although the PA241 can withstand differential input voltages up to 16V, in some applications additional external protection may be needed. Differential inputs exceeding 16V will be clipped by the protection circuitry. However, if more than a few milliamps of current is available from the overload source, the protection circuitry could be destroyed. For differential sources above 16V, adding series resistance limiting input current to 1mA will prevent damage. Alternatively, 1N4148 signal diodes connected anti-parallel across the input pins is usually sufficient. In more demanding applications where bias current is important, diode connected JFETs such as 2N4416 will be required. See Q1 and Q2 in Figure 1. In either case the differential input voltage will be clamped to 0.7V. This is sufficient overdrive to produce the maximum power bandwidth.

In the case of inverting circuits where the +IN pin is grounded, the diodes mentioned above will also afford protection from excessive common mode voltage. In the case of non-inverting circuits, clamp diodes from each input to each supply will provide protection. Note that these diodes will have substantial reverse bias voltage under normal operation and diode leakage will produce errors.

Some applications will also need over-voltage protection devices connected to the power supply rails. Unidirectional zener diode transient suppressors are recommended. The zeners clamp transients to voltages within the power supply rating and also clamp power supply reversals to ground. Whether the zeners are used or not the system power supply should be evaluated for transient performance including power-on overshoot and power-off polarity reversals as well as line regulation. See Z1 and Z2 in Figure 1.

APPLICATION NOTES

For additional technical information please refer to the following Application Notes:

AN1: General Operating Considerations

AN3: Bridge Circuit Drives

AN38: Loop Stability with Reactive Loads

AN38: Loop Stability with Reactive Loads

CONTACTING CIRRUS LOGIC SUPPORT

For all Apex Precision Power product questions and inquiries, call toll free 800-546-2739 in North America.

For inquiries via email, please contact apex.support@cirrus.com.

International customers can also request support by contacting their local Cirrus Logic Sales Representative.

To find the one nearest to you, go to www.cirrus.com

IMPORTANT NOTICE

Cirrus Logic, Inc. and its subsidiaries ("Cirrus") believe that the information contained in this document is accurate and reliable. However, the information is subject to change without notice and is provided "AS IS" without warranty of any kind (express or implied). Customers are advised to obtain the latest version of relevant information to verify, before placing orders, that information being relied on is current and complete. All products are sold subject to the terms and conditions of sale supplied at the time of order acknowledgment, including those pertaining to warranty for the use of this information, including use of this information as the basis for manufacture or sale of any items, or for infringement of patents or other rights of third parties. This document is the property of Cirrus and by furnishing this information, Cirrus grants no license, express or implied under any patents, mask work rights, copyrights, trademarks, trade secrets or other intellectual property rights. Cirrus owns the copyrights associated with the information contained herein and gives consent for copies to be made of the information only for use within your organization with respect to Cirrus integrated circuits or other products of Cirrus. This consent does not extend to other copying such as copying for general distribution, advertising or promotional purposes, or for creating any work for resale.

CERTAIN APPLICATIONS USING SEMICONDUCTOR PRODUCTS MAY INVOLVE POTENTIAL RISKS OF DEATH, PERSONAL INJURY, OR SEVERE PROPERTY OR ENVIRONMENTAL DAMAGE ("CRITICAL APPLICATIONS"). CIRRUS PRODUCTS ARE NOT DESIGNED, AUTHORIZED OR WARRANTED TO BE SUITABLE FOR USE IN PRODUCTS SURGICALLY IMPLANTED INTO THE BODY, AUTOMOTIVE SAFETY OR SECURITY DEVICES, LIFE SUPPORT PRODUCTS OR OTHER CRITICAL APPLICATIONS. INCLUSION OF CIRRUS PRODUCTS IN SUCH APPLICATIONS IS UNDERSTOOD TO BE FULLY AT THE CUSTOMER'S RISK AND CIRRUS DISCLAIMS AND MAKES NO WARRANTY, EXPRESS, STATUTORY OR IMPLIED, INCLUDING THE IMPLIED WARRANTIES OF MERCHANTABILITY AND FITNESS FOR PARTICULAR PURPOSE, WITH REGARD TO ANY CIRRUS PRODUCT THAT IS USED IN SUCH A MANNER. IF THE CUSTOMER OR CUSTOMER'S CUSTOMER USES OR PERMITS THE USE OF CIRRUS PRODUCTS IN CRITICAL APPLICATIONS, CUSTOMER AGREES, BY SUCH USE, TO FULLY INDEMNIFY CIRRUS, ITS OFFICERS, DIRECTORS, EMPLOYEES, DISTRIBUTORS AND OTHER AGENTS FROM ANY AND ALL LIABILITY, INCLUDING ATTORNEYS' FEES AND COSTS, THAT MAY RESULT FROM OR ARISE IN CONNECTION WITH THESE USES.

Cirrus Logic, Cirrus, and the Cirrus Logic logo designs, Apex Precision Power, Apex and the Apex Precision Power logo designs are trademarks of Cirrus Logic, Inc. All other brand and product names in this document may be trademarks or service marks of their respective owners.