

Silicon NPN Power Transistors

2SC4742

DESCRIPTION

- With TO-3PN package
- Built-in damper diode
- High breakdown voltage

APPLICATIONS

- Character display horizontal deflection output applications

PINNING

| PIN | DESCRIPTION |
|-----|--------------------------------------|
| 1 | Base |
| 2 | Collector;connected to mounting base |
| 3 | Emitter |

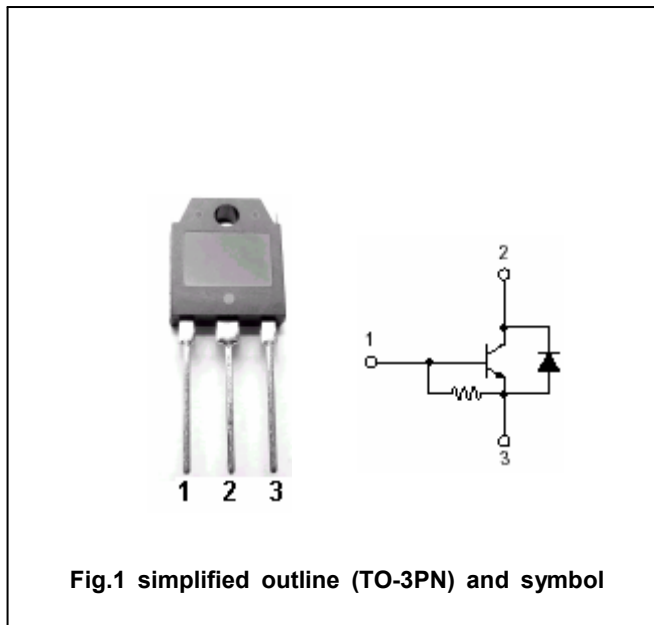

Fig.1 simplified outline (TO-3PN) and symbol

Absolute maximum ratings(Ta=□)

| SYMBOL | PARAMETER | CONDITIONS | VALUE | UNIT |
|-----------------------|------------------------------|---------------------|---------|------|
| V _{CEO} | Collector-emitter voltage | Open base | 1500 | V |
| V _{EBO} | Emitter-base voltage | Open collector | 6 | V |
| I _C | Collector current | | 6 | A |
| I _{CM} | Collector current-peak | | 7 | A |
| I _{C(surge)} | Collector current-surge | | 16 | A |
| I _o | C to E diode forward current | | 7 | A |
| P _C | Collector power dissipation | T _C =25□ | 50 | W |
| T _j | Junction temperature | | 150 | □ |
| T _{stg} | Storage temperature | | -55~150 | □ |

Silicon NPN Power Transistors

2SC4742

CHARACTERISTICS

T_j=25°C unless otherwise specified

| SYMBOL | PARAMETER | CONDITIONS | MIN | TYP. | MAX | UNIT |
|----------------------|--------------------------------------|---|-----|------|-----|------|
| V _{(BR)EBO} | Emitter-base breakdown voltage | I _E =400mA ; I _C =0 | 6 | | | V |
| I _{CES} | Collector cut-off current | V _{CE} =1500V; R _{BE} =0 | | | 0.5 | mA |
| h _{FE} | DC current gain | I _C =1A ; V _{CE} =5V | | | 25 | |
| V _{CE(sat)} | Collector-emitter saturation voltage | I _C =5A ; I _B =1.25A | | | 2.0 | V |
| V _{BE(sat)} | Base-emitter saturation voltage | I _C =5A ; I _B =1.25A | | | 1.5 | V |
| V _{ECF} | Diode forward voltage | I _F =6A | | | 2.0 | V |
| t _f | Fall time | I _{CP} =5A; I _{B1} =1A; I _{B2} =-2A | | | 0.4 | μs |

Silicon NPN Power Transistors

2SC4742

PACKAGE OUTLINE

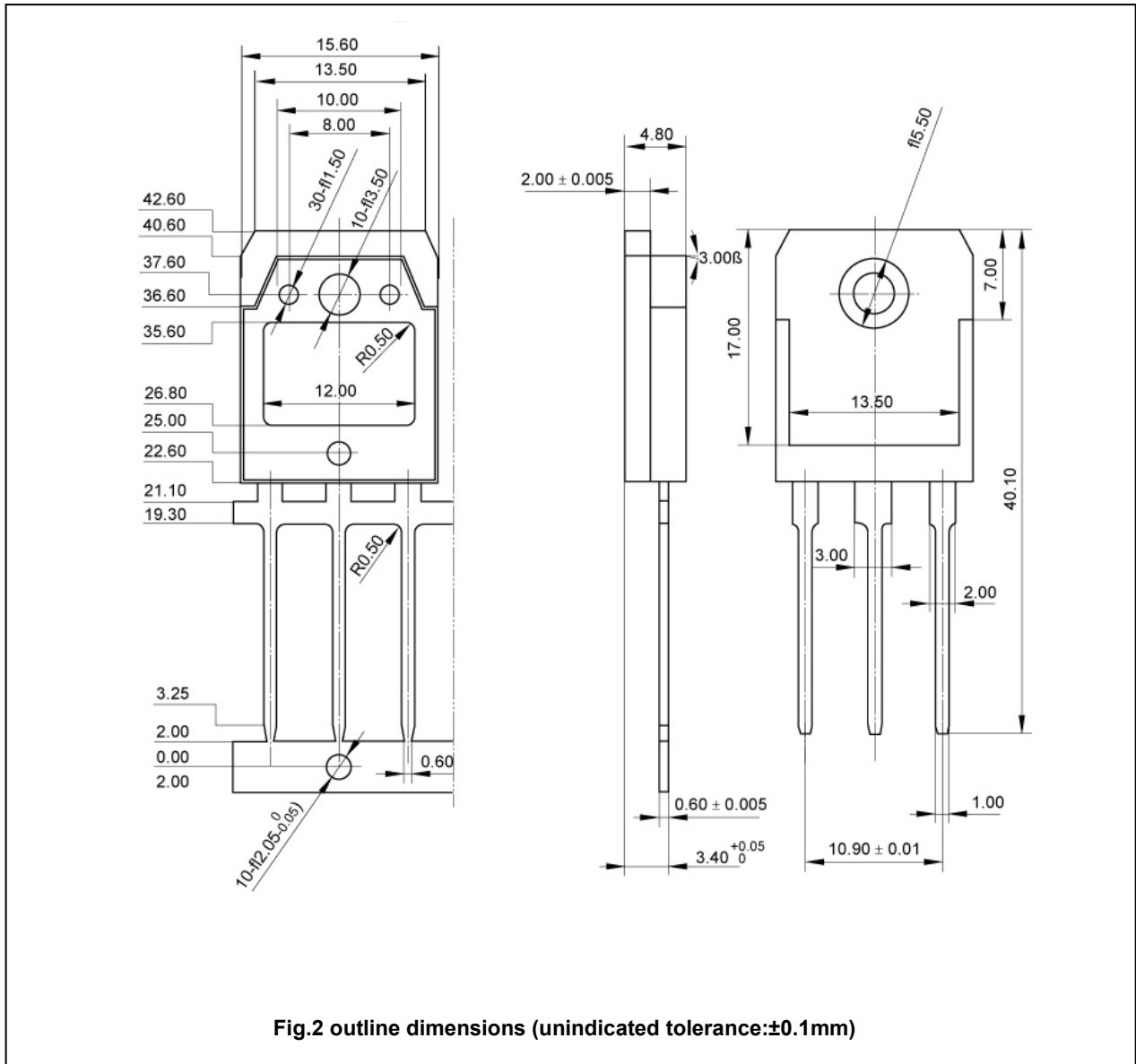

Silicon NPN Power Transistors

2SC4742

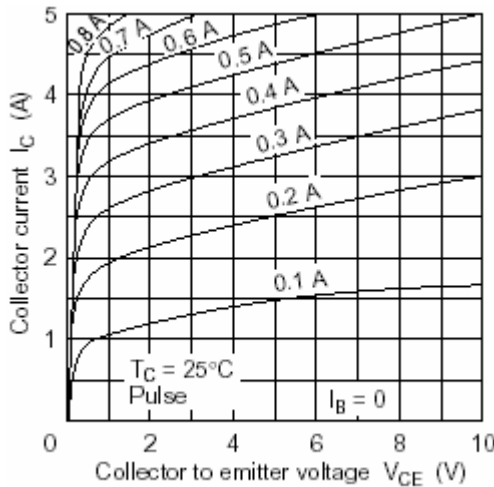

Fig.3 Static Characteristic

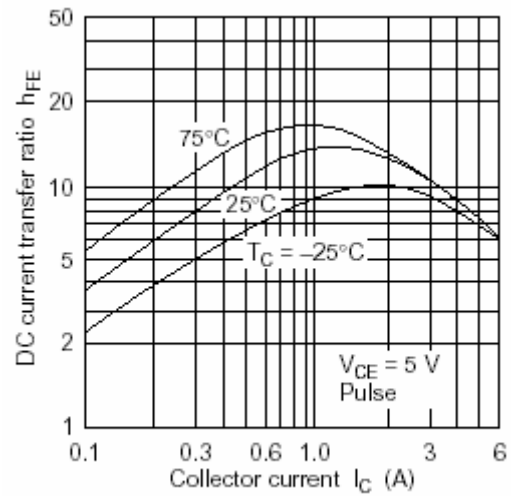

Fig.4 DC current Gain

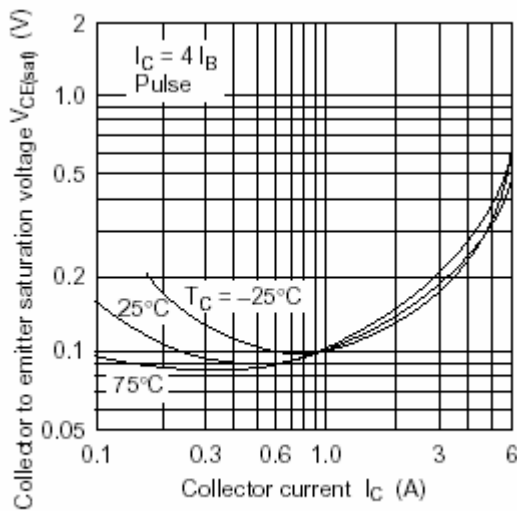

Fig.5 Collector-Emitter Saturation Voltage

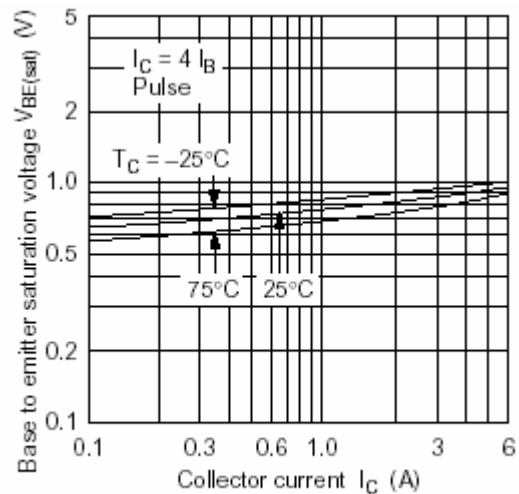

Fig.6 Base-Emitter Saturation Voltage

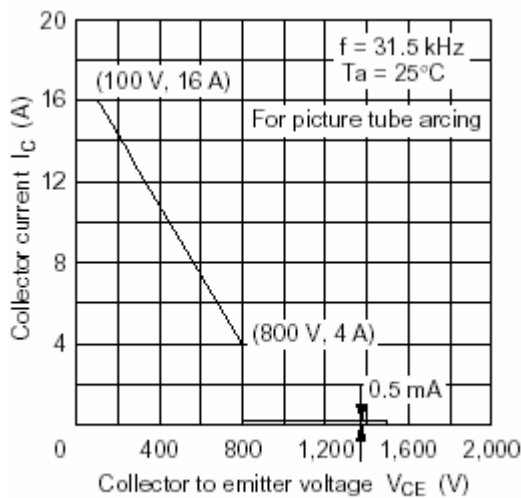

Fig.7 Safe Operating Area