

Spezifikation für Freigabe / specification for release

Kunde / customer :
 Artikelnummer / part number : **7448640403**
 Bezeichnung : **STROMKOMPENSIERTE DROSSEL WE-FC**
 description : **CURRENT-COMPENSATED CHOKE WE-FC**



DATUM / DATE : 2009-08-06

H Einfügungsdämpfung / insertion loss:

typischer Dämpfungsverlauf / typical attenuation curve

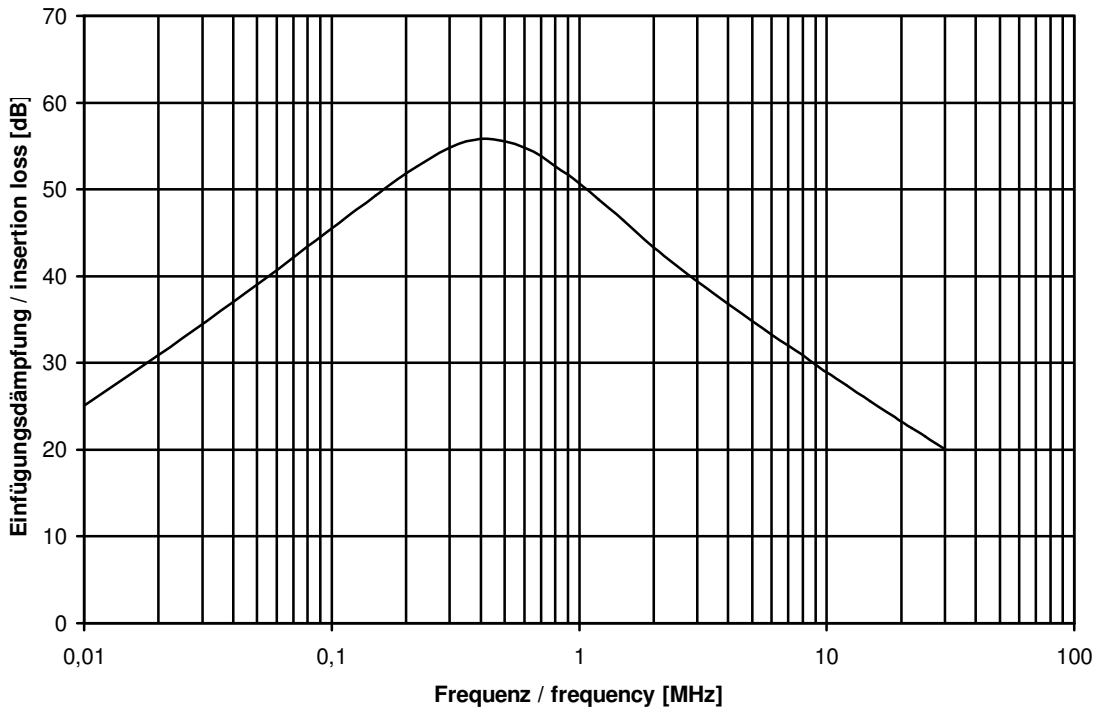

common mode

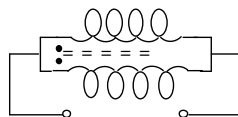

Datum / date			
Geprüft / checked	Kontrolliert / approved	MST	Version 1	09-08-06
Geprüft / checked	Kontrolliert / approved	Name	Änderung / modification	Datum / date

This electronic component has been designed and developed for usage in general electronic equipment. Before incorporating this component into any equipment where higher safety and reliability is especially required or if there is the possibility of direct damage or injury to human body, for example in the range of aerospace, aviation, nuclear control, submarine, transportation, (automotive control, train control, ship control), transportation signal, disaster prevention, medical, public information network etc, Würth Elektronik eiSos GmbH must be informed before the design-in stage. In addition, sufficient reliability evaluation checks for safety must be performed on every electronic component which is used in electrical circuits that require high safety and reliability functions or performance.

Würth Elektronik eiSos GmbH & Co. KG

D-74638 Waldenburg · Max-Eyth-Strasse 1 - 3 · Germany · Telefon (+49) (0) 7942 - 945 - 0 · Telefax (+49) (0) 7942 - 945 - 400
<http://www.we-online.com>

Spezifikation für Freigabe / specification for release

Kunde / customer :
 Artikelnummer / part number : 7448640403
 Bezeichnung : STROMKOMPENSIERTE DROSSEL WE-FC
 description : CURRENT-COMPENSATED CHOKE WE-FC



DATUM / DATE : 2009-08-06

I Stangenspezifikation / tube specification:

Stangenspezifikation / tube specification:		
L	525	mm
H	31	mm
B	24,5	mm

Menge: 23 Stück/Stange
 quantity: 23 pieces/tube

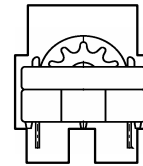
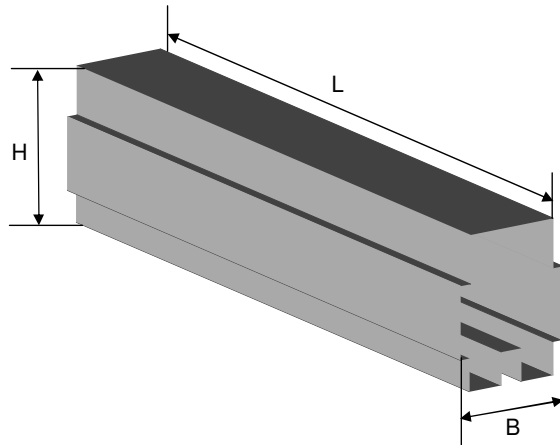

Freigabe erteilt / general release:	Kunde / customer		
.....		
Datum / date	Unterschrift / signature		
	Würth Elektronik		
.....		
Geprüft / checked	Kontrolliert / approved		
	MST Name	Version 1 Änderung / modification	09-08-06 Datum / date

This electronic component has been designed and developed for usage in general electronic equipment. Before incorporating this component into any equipment where higher safety and reliability is especially required or if there is the possibility of direct damage or injury to human body, for example in the range of aerospace, aviation, nuclear control, submarine, transportation, (automotive control, train control, ship control), transportation signal, disaster prevention, medical, public information network etc, Würth Elektronik eiSos GmbH must be informed before the design-in stage. In addition, sufficient reliability evaluation checks for safety must be performed on every electronic component which is used in electrical circuits that require high safety and reliability functions or performance.

Würth Elektronik eiSos GmbH & Co. KG

D-74638 Waldenburg · Max-Eyth-Strasse 1 - 3 · Germany · Telefon (+49) (0) 7942 - 945 - 0 · Telefax (+49) (0) 7942 - 945 - 400
<http://www.we-online.com>