



PRODUCT SPECIFICATION

Model No : CSLR-N55BSB4-A0

Descriptions:	
■ LED Type	: Lighting LED Lamp
■ LED Package	: Round LED Lamp
■ Emitting Color	: Blue
■ Viewing Angle	: 70°
■ No Stopper	



CUSTOMER APPROVED SIGNATURES	APPROVED BY	CHECKED BY	PREPARED BY

CHINA SEMICONDUCTOR CORPORATION
Address: 2FL. NO.909, Chung-Cheng Road,
Chung-Ho City Taipei Hsien, Taiwan.

OPTO PLUS TECHNOLOGIES CO.,LTD
Address: 696 Shun jiang Rd., Ji Shan St. Shaoxing,
ZheJiang, China

Tel: 886-2-2223-9696
Fax: 886-2-2223-9377

Tel: 86-0575-88623888
Fax: 86-0575-88623112



Spec. No.	PS-LL-N55BSB4-A0
Rev.	A

Model No : CSLR-N55BSB4-A0

Features -

1. Low Power Consumption.
2. High Luminous Output
3. High Reliability and Solid Performance
4. Optimal Optical/Mechanical Design
5. Rohs Compliant

Device Selection Guide -

Part No.	Chip		LED Lens
	Material	Emitted Color	
CSLR-N55BSB4-A0	InGaN	Blue	Water Transparent

Package Outline Dimensions -

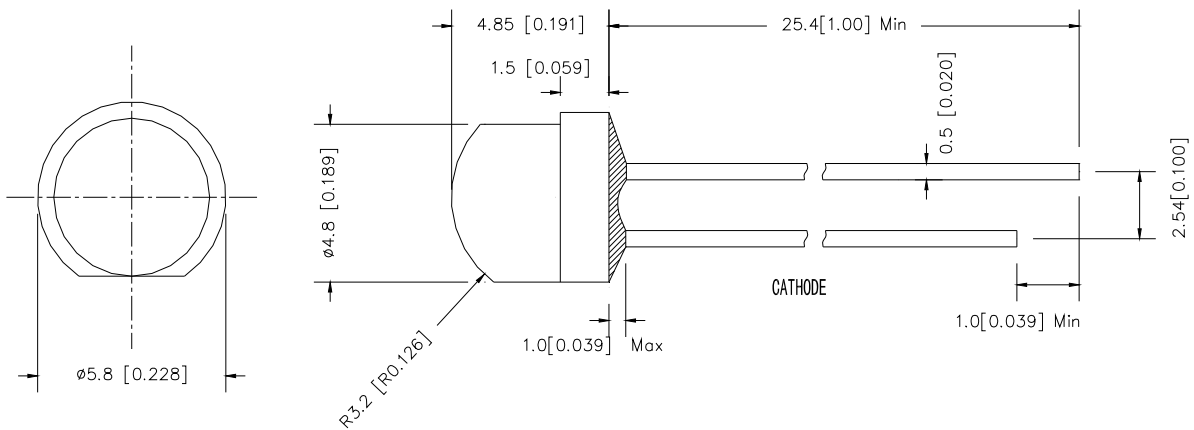

* Tolerance : $\pm \frac{0.01}{0.25}$ Unit : $\pm \frac{\text{inch}}{\text{mm}}$



Model No : CSLR-N55BSB4-A0

■ Absolute Maximum Rating -

(Ta=25°C)

Parameter	Symbol	Rating	Unit
Power Dissipation	Pd	76	mW
Forward Current (DC)	IF	30	mA
Peak Forward Current *	IFP	100	mA
Reverse Voltage	VR	5	V
Operating Temp.	Topr	-30 ~ +80	°C
Storage Temp.	Tstg	-40 ~ +100	°C
Lead Soldering Temperature	Tsol	Max. 260°C for 5 sec Max. (3mm from the epoxy body)	

* Pulse width ≤ 0.1 msec. duty $\leq 1/10$

■ Electro-optical Characteristics

(Ta=25°C)

Parameter	Symbol	Min.	Typ.	Max.	Unit	Condition
Forward Voltage	VF	-----	3.1	3.8	V	IF=20mA
Luminous Intensity	Iv	290	500	-----	mcd	
Dominant Wavelength	λD	-----	465	-----	nm	
Viewing Angle	2 θ 1/2	-----	70	-----	deg	
Reverse Current	IR	-----	-----	50	μ A	VR=5V



Model No : CSLR-N55BSB4-A0

■ **Luminous Intensity Rank Limits ($I_f = 20mA$)**

unit : mcd

Part No. Code	CSLR-N55BSB4-A0	
	min.	max.
H	290	380
J	380	490
K	490	640
L	640	830
M	830	1080

■ **Dominant Wavelength Rank Limits ($I_f = 20mA$)**

unit : nm

Part No. Code	CSLR-N55BSB4-A0	
	min.	max.
B5	460	465
B6	465	470
B7	470	475

■ **Forward Voltage Rank Limits ($I_f = 20mA$)**

unit : v

Part No. Code	CSLR-N55BSB4-A0	
	min.	max.
H	2.8	3.0
J	3.0	3.2
K	3.2	3.4
L	3.4	3.6
M	3.6	3.8

Notes:

1. Tolerance of measurement of luminous intensity :±15%
2. Tolerance of measurement of Color Coordinates :±0.01
3. Tolerance of measurement of forward voltage :±0.05v
4. All data are measured by CSC's test equipment.
5. One delivery will include several color rank, VF rank and Iv ranks of the products.
6. The quantity-ratio of the ranks is decided by CSC.
7. Please confirm with CSC salesman,if your request different form standard specification.



Spec. No.	PS-LL-N55BSB4-A0
Rev.	A

Model No : CSLR-N55BSB4-A0

■ Typical Electrical / Optical Characteristics Curves -

($T_a = 25^\circ\text{C}$ Unless Otherwise Noted)

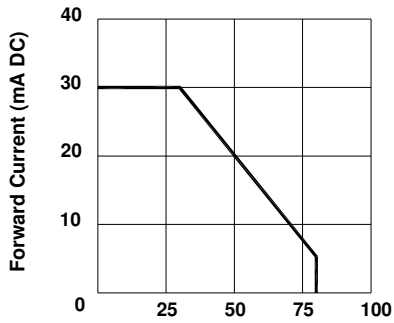

Ambient Temperature T_a ($^\circ\text{C}$)
Fig 1. Forward Current
Vs. Ambient Temperature

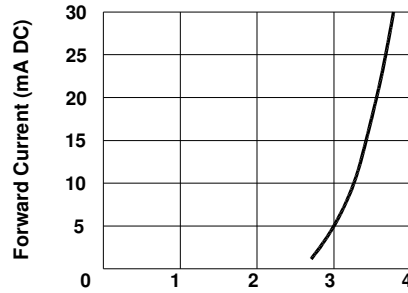

Forward Voltage V_F (V)
Fig 2. Forward Current
Vs. Forward Voltage



Forward Current I_F (mA DC)
Fig 3. Relative Intensity
Vs. Forward Current

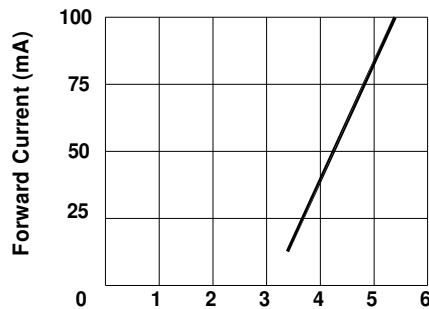

Forward Voltage (V)
Fig 4. Peak Forward Voltage
Vs. Forward Current
(100us test pulse, 1% duty cycle)

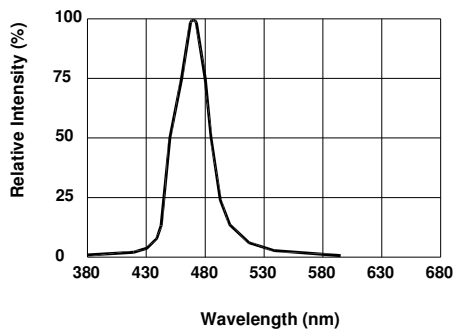

Fig 5. Relative Intensity Vs. Wavelength

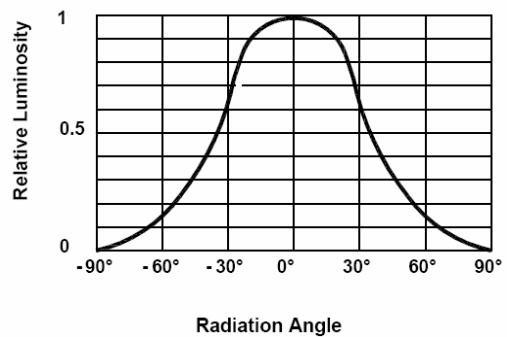

Fig 6. Relative Luminous Intensity vs. Radiation Angle



Model No : CSLR-N55BSB4-A0

■ Precautions For Use -

1. Recommended Soldering conditions

Wave Soldering

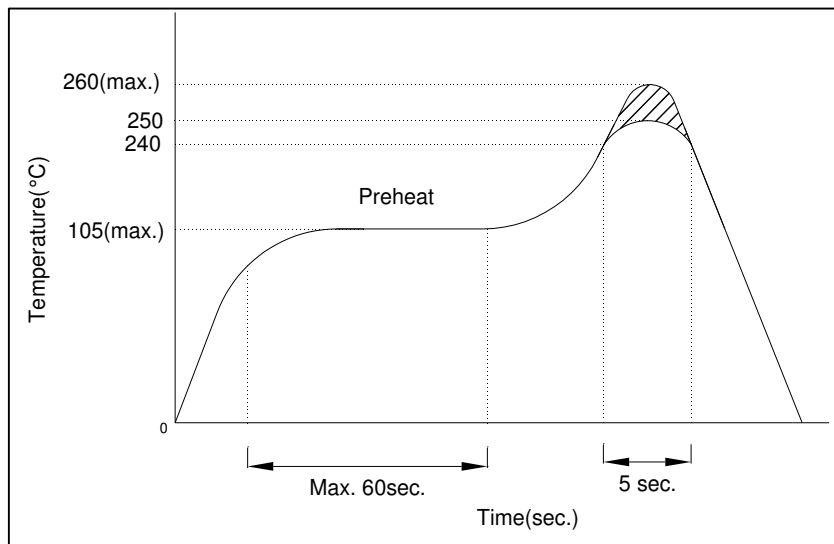

2. Soldering Iron

Basic SPEC. is ≤ 5 sec. When 260°C . If temperature is higher, time should be shorter ($+10^{\circ}\text{C} \rightarrow -1$ sec.). Power dissipation of iron should be smaller than 15W, and temperature should be controllable. Surface temperature of the device should be under 230°C .

3. Static Electricity

- a. Static electricity or surge voltage damages LEDs..

It is recommended that a wrist band or an anti-electrostatic glove be used when handling the LEDs.

- b. All devices, equipment and machinery must be properly grounded. It is recommended that measures be taken against surge voltage to the equipment that mounts the LEDs.

Note: The specifications are subject to change without notice. Please contact us for updated information.