



Band Pass

Description:

The D64BP Series of small 2-pole-pair fixed-frequency, precision band-pass active filter that provides high performance in a compact 32-pin DIP package, with a broad range of fixed center frequencies (f_0) from 1 Hz to 100 kHz. Each filter type features a near theoretical amplitude/phase response along with low output voltage noise enabling these filters to achieve a 10,000:1 or better dynamic signal range.

Pretuned to within $\pm 2\%$ of the fixed, user specified center frequency, band-pass D64BP filters pass all frequencies lying between the upper and lower -3dB points of the amplitude response curve. Available Q's for D64BP models are 1, 2, 5, or 10.



Features/Benefits:

- Compact 1.8"L x 0.8"W x 0.3"H minimizes board space requirements.
- Plug-in ready-to-use, reducing engineering design and manufacturing cycle time.
- Factory tuned, no external clocks or adjustments needed.
- Broad range of center frequencies to meet a wide range of applications.

Applications

- Power line interference rejection
- Transducer output filtering
- Production test instrumentation
- Medical electronics equipment and research
- Comb filtering and equalization
- Noise and harmonic analysis
- RMS measurements
- Frequency spectrum analysis

Available Band-Pass Models:

D64BP2	2 pole pair	2
---------------	-------------	-------	---

General Specifications:

Ordering Information	3
Pin-Out/Package Data	3



Band-Pass

Model	D64BP2
Product Specifications	Band-Pass
Size	1.8" x 0.8" x 0.3"
Range f_o	1 Hz to 100 kHz
Available "Q's"¹	1, 2, 5, 10
"Q" Accuracy	±10 %
Theoretical Transfer Characteristics	Appendix A Pages 39 & 40
Pass-Band Gain (non-inverting)	0 ± 0.2 dB typ 0 ± 0.4 dB max.
Attenuation Rate	12 dB/octave
Center Frequency	f_o ±2% max.
Stability	±0.01%/°C
Filter Mounting Assembly	FMA-01A

1. Q – Quality Factor for band-pass filters. $Q = f_o / (f_H - f_L)$

$$f_o = \sqrt{f_H f_L}$$



Specification (25°C and Vs ±15Vdc)

Pin-Out and Package Data Ordering Information

Analog Input Characteristics¹

Impedance	10 k Ω min.
Voltage Range	± 10 Vpeak
Max. Safe Voltage	±Vs

Analog Output Characteristics

Impedance (Closed Loop)	1 Ω typ. 10 Ω max.
Linear Operating Range	±10V
Maximum Current ²	±2 mA
Offset Voltage ³	2 mV typ. 20 mV max.
Offset Temp. Coeff.	50 μV/°C

Power Supply (±V)

Rated Voltage	±15 Vdc
Operating Range	±5 to ±18 Vdc
Maximum Safe Voltage	±18 Vdc
Quiescent Current	±12.5 mA typ. ±20 mA max.

Temperature

Operating	0 to +70°C
Storage	-25 to +85°C

Pin-Out & Package Data

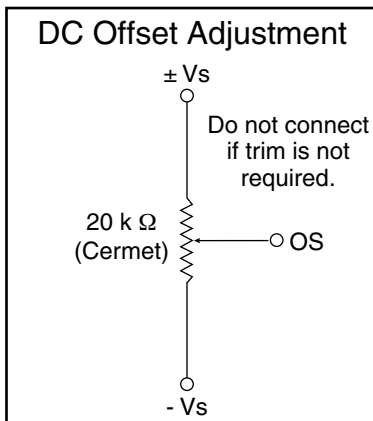
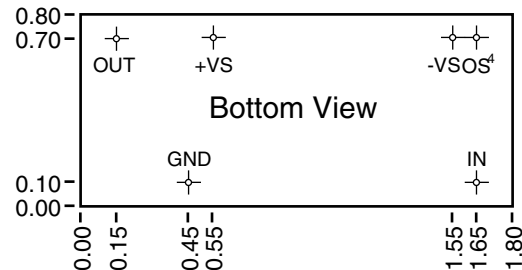
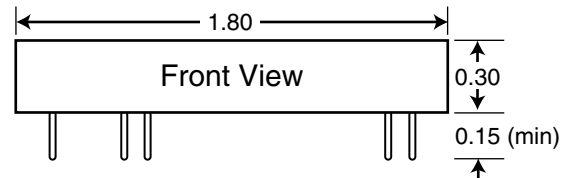
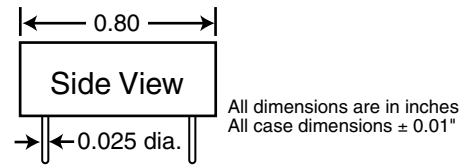

Ordering Information

D64BP2/10-849 Hz

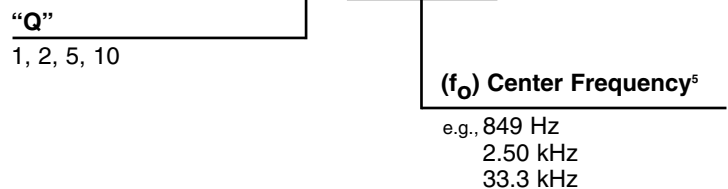

Notes:

1. Input and output signal voltage referenced to supply common.
2. Output is short circuit protected to common. DO NOT CONNECT TO ±Vs.
3. Adjustable to zero.
4. Units operate with or without offset pin connected.
5. How to Specify Center Frequency:
Center frequencies are specified by attaching a three digit frequency designator to the basic model number. Center frequencies can range from 1 Hz to 100 kHz.

We hope the information given here will be helpful. The information is based on data and our best knowledge, and we consider the information to be true and accurate. Please read all statements, recommendations or suggestions herein in conjunction with our conditions of sale which apply to all goods supplied by us. We assume no responsibility for the use of these statements, recommendations or suggestions, nor do we intend them as a recommendation for any use which would infringe any patent or copyright. IN-D64BP-02



Appendix A

Amplitude Response Curves

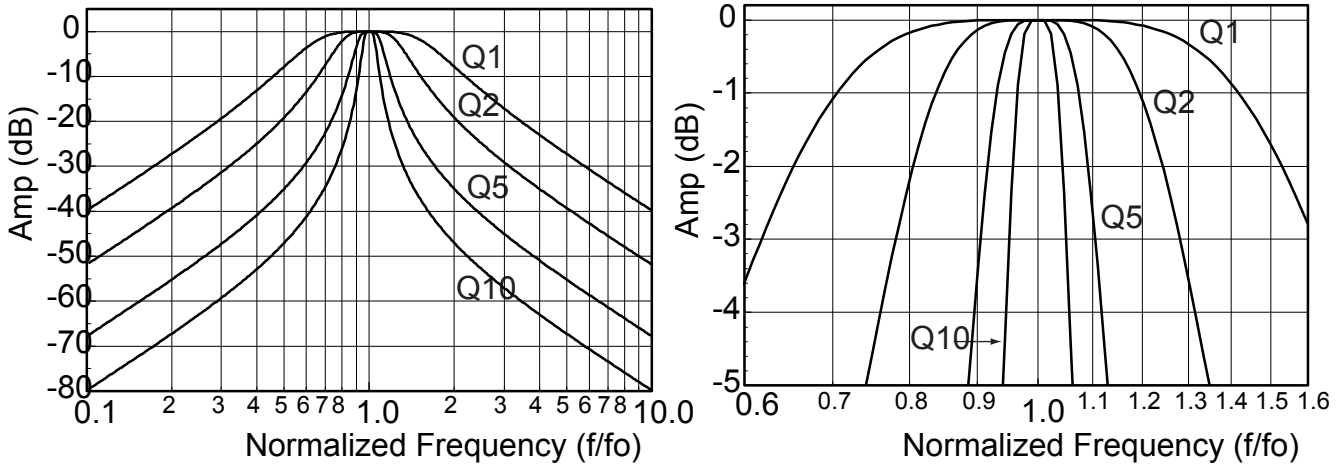

Amp (dB)	Q = 1		Q = 2		Q = 5		Q = 10	
	$f_L < f_o < f_H$		$f_L < f_o < f_H$		$f_L < f_o < f_H$		$f_L < f_o < f_H$	
	f/f_o	f/f_o	f/f_o	f/f_o	f/f_o	f/f_o	f/f_o	f/f_o
-0.10	0.824	1.214	0.907	1.102	0.962	1.040	0.981	1.020
-0.25	0.783	1.277	0.884	1.131	0.952	1.051	0.976	1.025
-0.50	0.747	1.338	0.863	1.159	0.943	1.061	0.971	1.030
-1.00	0.705	1.418	0.837	1.194	0.931	1.074	0.965	1.036
-1.50	0.677	1.478	0.820	1.220	0.923	1.083	0.961	1.041
-2.00	0.654	1.529	0.805	1.242	0.916	1.091	0.957	1.045
-2.50	0.635	1.574	0.792	1.262	0.910	1.098	0.954	1.048
-3.00	0.618	1.617	0.781	1.280	0.905	1.105	0.951	1.051
-5.00	0.563	1.776	0.742	1.348	0.886	1.129	0.941	1.062
-10.00	0.457	2.189	0.657	1.523	0.842	1.188	0.917	1.090
-15.00	0.368	2.720	0.572	1.748	0.792	1.263	0.889	1.125
-20.00	0.290	3.445	0.485	2.062	0.733	1.364	0.855	1.170
-25.00	0.225	4.439	0.399	2.506	0.664	1.507	0.811	1.233
-30.00	0.173	5.795	0.319	3.130	0.585	1.709	0.758	1.320
-35.00	0.131	7.630	0.250	3.999	0.500	2.000	0.693	1.443
-40.00	0.099	10.09	0.193	5.192	0.414	2.414	0.618	1.618
-45.00	0.075	13.41	0.147	6.814	0.333	3.001	0.535	1.869
-50.00	0.056	17.83	0.111	9.002	0.262	3.819	0.449	2.228
-55.00	0.042	23.75	0.084	11.94	0.202	4.945	0.365	2.737
-60.00	0.032	31.65	0.063	15.87	0.154	6.479	0.290	3.453
-65.00	0.024	42.19	0.047	21.13	0.117	8.552	0.225	4.443
-70.00	0.018	56.25	0.036	28.15	0.088	11.33	0.172	5.798
-75.00	0.013	75.00	0.027	37.52	0.066	15.06	0.131	7.632
-80.00	0.010	100.0	0.020	50.01	0.050	20.05	0.099	10.10



Phase Response Curves

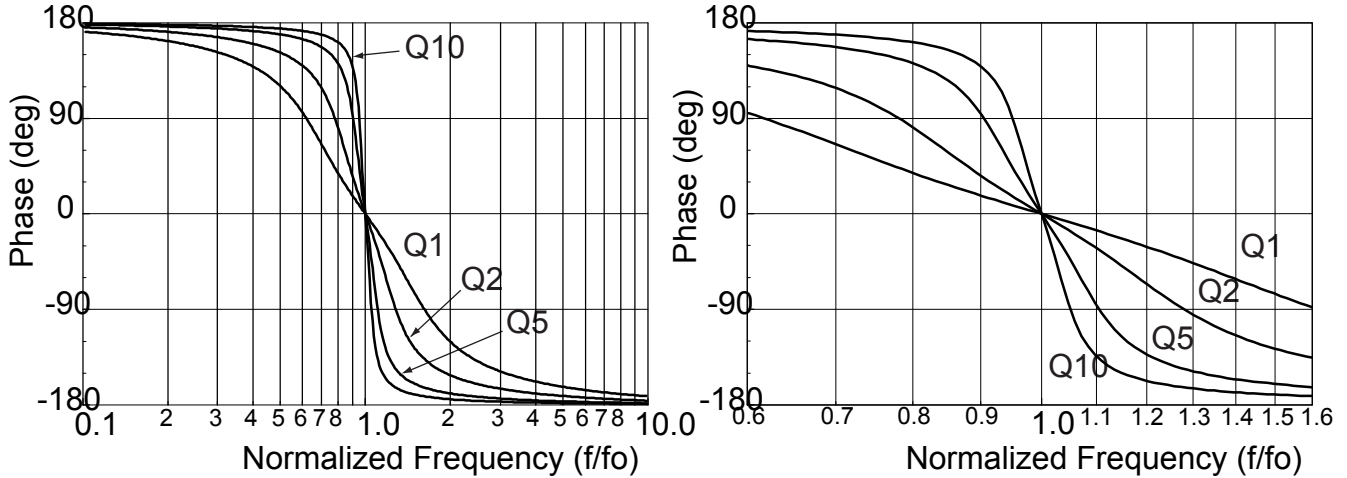

Normalized Theoretical Phase Data

Phase Mag (deg)	Q = 1		Q = 2		Q = 5		Q = 10	
	(+)	(-)	(+)	(-)	(+)	(-)	(+)	(-)
	f/f ₀	f/f ₀	f/f ₀	f/f ₀	f/f ₀	f/f ₀	f/f ₀	f/f ₀
1.0	0.994	1.006	0.997	1.003	0.999	1.001	0.999	1.001
2.5	0.985	1.016	0.992	1.008	0.997	1.003	0.998	1.002
5.0	0.970	1.031	0.985	1.016	0.994	1.006	0.997	1.003
10.0	0.940	1.063	0.970	1.031	0.988	1.012	0.994	1.006
15.0	0.913	1.096	0.955	1.047	0.982	1.018	0.991	1.009
20.0	0.886	1.128	0.941	1.062	0.976	1.025	0.988	1.012
25.0	0.861	1.161	0.928	1.078	0.970	1.030	0.985	1.015
30.0	0.838	1.194	0.915	1.093	0.965	1.036	0.982	1.018
35.0	0.815	1.227	0.902	1.108	0.960	1.042	0.980	1.021
40.0	0.794	1.259	0.891	1.123	0.955	1.048	0.977	1.024
45.0	0.774	1.292	0.879	1.138	0.950	1.053	0.974	1.026
50.0	0.755	1.324	0.868	1.152	0.945	1.059	0.972	1.029
60.0	0.719	1.391	0.846	1.182	0.935	1.069	0.967	1.034
70.0	0.685	1.460	0.825	1.212	0.925	1.081	0.962	1.040
80.0	0.652	1.535	0.803	1.245	0.916	1.092	0.957	1.045
90.0	0.618	1.618	0.781	1.281	0.905	1.105	0.951	1.051
105.0	0.564	1.772	0.743	1.346	0.887	1.128	0.941	1.062
120.0	0.502	1.991	0.695	1.439	0.862	1.160	0.928	1.077
135.0	0.424	2.356	0.628	1.594	0.825	1.212	0.908	1.101
150.0	0.320	3.126	0.520	1.923	0.758	1.319	0.869	1.150
165.0	0.177	5.639	0.327	3.058	0.593	1.686	0.764	1.310
180.0	0	inf	0	inf	0	inf	0	inf