

NTMFS4841NH

Power MOSFET

30 V, 59 A, Single N-Channel, SO-8FL

Features

- Low $R_{DS(on)}$ to Minimize Conduction Losses
- Low Capacitance to Minimize Driver Losses
- Optimized Gate Charge to Minimize Switching Losses
- Low R_G
- These are Pb-Free Devices*

Applications

- Refer to Application Note AND8195/D
- CPU Power Delivery
- DC-DC Converters

MAXIMUM RATINGS ($T_J = 25^\circ\text{C}$ unless otherwise stated)

Parameter	Symbol	Value	Unit	
Drain-to-Source Voltage	V_{DSS}	30	V	
Gate-to-Source Voltage	V_{GS}	± 20	V	
Steady State	Continuous Drain Current $R_{\theta JA}$ (Note 1)	$T_A = 25^\circ\text{C}$	I_D 13.5	A
		$T_A = 85^\circ\text{C}$	9.7	
	Power Dissipation $R_{\theta JA}$ (Note 1)	$T_A = 25^\circ\text{C}$	P_D 2.16	W
		$T_A = 85^\circ\text{C}$	1.1	
	Continuous Drain Current $R_{\theta JA} \leq 10$ s	$T_A = 25^\circ\text{C}$	I_D 21.8	A
		$T_A = 85^\circ\text{C}$	15.7	
	Power Dissipation $R_{\theta JA} \leq 10$ s	$T_A = 25^\circ\text{C}$	P_D 5.7	W
		$T_A = 85^\circ\text{C}$	2.9	
	Continuous Drain Current $R_{\theta JA}$ (Note 2)	$T_A = 25^\circ\text{C}$	I_D 8.6	A
		$T_A = 85^\circ\text{C}$	6.2	
Power Dissipation $R_{\theta JA}$ (Note 2)	$T_A = 25^\circ\text{C}$	P_D 0.87	W	
	$T_A = 85^\circ\text{C}$	0.45		
Continuous Drain Current $R_{\theta JC}$ (Note 1)	$T_C = 25^\circ\text{C}$	I_D 59	A	
	$T_C = 85^\circ\text{C}$	42.5		
Power Dissipation $R_{\theta JC}$ (Note 1)	$T_C = 25^\circ\text{C}$	P_D 41.7	W	
	$T_C = 85^\circ\text{C}$	21.7		
Pulsed Drain Current	$t_p = 10 \mu\text{s}$	$T_A = 25^\circ\text{C}$	I_{DM} 177	A
Operating Junction and Storage Temperature		T_J, T_{STG}	-55 to +150	$^\circ\text{C}$
Source Current (Body Diode)		I_S	35	A
Drain to Source dV/dt		dV/dt	6	V/ns
Single Pulse Drain-to-Source Avalanche Energy ($V_{DD} = 24$ V, $V_{GS} = 10$ V, $I_L = 25.6$ A, $L = 0.3$ mH, $R_G = 25 \Omega$)		EAS	98	mJ
Lead Temperature for Soldering Purposes (1/8" from case for 10 s)		T_L	260	$^\circ\text{C}$

Stresses exceeding Maximum Ratings may damage the device. Maximum Ratings are stress ratings only. Functional operation above the Recommended Operating Conditions is not implied. Extended exposure to stresses above the Recommended Operating Conditions may affect device reliability.

1. Surface-mounted on FR4 board using 1 sq-in pad, 1 oz Cu.
2. Surface-mounted on FR4 board using the minimum recommended pad size.



ON Semiconductor®

<http://onsemi.com>

$V_{(BR)DSS}$	$R_{DS(ON)}$ MAX	I_D MAX
30 V	7.0 m Ω @ 10 V	59 A
	11.6 m Ω @ 4.5 V	

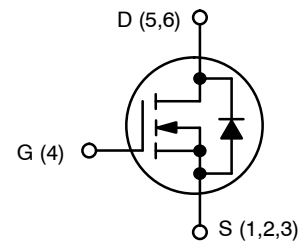

N-CHANNEL MOSFET

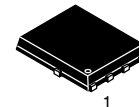

SO-8 FLAT LEAD
CASE 488AA
STYLE 1

MARKING DIAGRAM

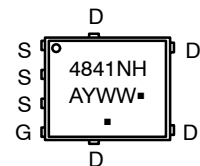

- A = Assembly Location
 - Y = Year
 - WW = Work Week
 - = Pb-Free Package
- (Note: Microdot may be in either location)

ORDERING INFORMATION

Device	Package	Shipping†
NTMFS4841NHT1G	SO-8FL (Pb-Free)	1500 / Tape & Reel
NTMFS4841NHT3G	SO-8FL (Pb-Free)	5000 / Tape & Reel

†For information on tape and reel specifications, including part orientation and tape sizes, please refer to our Tape and Reel Packaging Specifications Brochure, BRD8011/D.

*For additional information on our Pb-Free strategy and soldering details, please download the ON Semiconductor Soldering and Mounting Techniques Reference Manual, SOLDERRM/D.

NTMFS4841NH

THERMAL RESISTANCE MAXIMUM RATINGS

Parameter	Symbol	Value	Unit
Junction-to-Case (Drain)	$R_{\theta JC}$	3	°C/W
Junction-to-Ambient – Steady State (Note 1)	$R_{\theta JA}$	57.8	
Junction-to-Ambient – Steady State (Note 2)	$R_{\theta JA}$	143.5	
Junction-to-Ambient ($t \leq 10$ s)	$R_{\theta JA}$	22.1	

ELECTRICAL CHARACTERISTICS ($T_J = 25^\circ\text{C}$ unless otherwise specified)

Parameter	Symbol	Test Condition	Min	Typ	Max	Unit
OFF CHARACTERISTICS						
Drain-to-Source Breakdown Voltage	$V_{(BR)DSS}$	$V_{GS} = 0$ V, $I_D = 250$ μA	30			V
Drain-to-Source Breakdown Voltage Temperature Coefficient	$V_{(BR)DSS}/T_J$			28		mV/°C
Zero Gate Voltage Drain Current	I_{DSS}	$V_{GS} = 0$ V, $V_{DS} = 24$ V	$T_J = 25$ °C		1	μA
			$T_J = 125$ °C		10	
Gate-to-Source Leakage Current	I_{GSS}	$V_{DS} = 0$ V, $V_{GS} = \pm 20$ V			± 100	nA

ON CHARACTERISTICS (Note 3)

Gate Threshold Voltage	$V_{GS(TH)}$	$V_{GS} = V_{DS}$, $I_D = 250$ μA	1.5	2.1	2.5	V	
Negative Threshold Temperature Coefficient	$V_{GS(TH)}/T_J$			5.6		mV/°C	
Drain-to-Source On Resistance	$R_{DS(on)}$	$V_{GS} = 10$ V to 11.5 V	$I_D = 30$ A		4.8	7.0	m Ω
			$I_D = 15$ A		4.8		
		$V_{GS} = 4.5$ V	$I_D = 30$ A		8.8	11.6	
			$I_D = 15$ A		8.5		
Forward Transconductance	g_{FS}	$V_{DS} = 1.5$ V, $I_D = 50$ A		57		S	

CHARGES AND CAPACITANCES

Input Capacitance	C_{ISS}	$V_{GS} = 0$ V, $f = 1$ MHz, $V_{DS} = 12$ V		1565	2113	pF
Output Capacitance	C_{OSS}			325	439	
Reverse Transfer Capacitance	C_{RSS}			173	268	
Total Gate Charge	$Q_{G(TOT)}$	$V_{GS} = 4.5$ V, $V_{DS} = 15$ V; $I_D = 30$ A		11.3	16.7	nC
Threshold Gate Charge	$Q_{G(TH)}$			1.4	2.1	
Gate-to-Source Charge	Q_{GS}			5.3	7.9	
Gate-to-Drain Charge	Q_{GD}			4.5	6.8	
Total Gate Charge	$Q_{G(TOT)}$		$V_{GS} = 11.5$ V, $V_{DS} = 15$ V, $I_D = 30$ A		24.4	

SWITCHING CHARACTERISTICS (Note 4)

Turn-On Delay Time	$t_{d(ON)}$	$V_{GS} = 4.5$ V, $V_{DS} = 15$ V, $I_D = 15$ A, $R_G = 3.0$ Ω		12.1	18.1	ns
Rise Time	t_r			23.3	34.9	
Turn-Off Delay Time	$t_{d(OFF)}$			14.1	21.1	
Fall Time	t_f			4.9	7.3	
Turn-On Delay Time	$t_{d(ON)}$	$V_{GS} = 11.5$ V, $V_{DS} = 15$ V, $I_D = 15$ A, $R_G = 3.0$ Ω		7.2	10.7	ns
Rise Time	t_r			20.6	30.9	
Turn-Off Delay Time	$t_{d(OFF)}$			21.9	32.9	
Fall Time	t_f			2.9	4.4	

3. Pulse Test: pulse width ≤ 300 μs , duty cycle $\leq 2\%$.

4. Switching characteristics are independent of operating junction temperatures.

NTMFS4841NH

ELECTRICAL CHARACTERISTICS ($T_J = 25^\circ\text{C}$ unless otherwise specified)

Parameter	Symbol	Test Condition	Min	Typ	Max	Unit
-----------	--------	----------------	-----	-----	-----	------

DRAIN-SOURCE DIODE CHARACTERISTICS

Forward Diode Voltage	V_{SD}	$V_{GS} = 0\text{ V},$ $I_S = 30\text{ A}$	$T_J = 25^\circ\text{C}$		0.86	1.2	V
			$T_J = 125^\circ\text{C}$		0.71		
Reverse Recovery Time	t_{RR}	$V_{GS} = 0\text{ V}, dI_S/dt = 100\text{ A}/\mu\text{s},$ $I_S = 30\text{ A}$			18.8		ns
Charge Time	t_a				11.4		
Discharge Time	t_b				7.4		
Reverse Recovery Charge	Q_{RR}				6.7		

PACKAGE PARASITIC VALUES

Source Inductance	L_S	$T_A = 25^\circ\text{C}$		0.93		nH
Drain Inductance	L_D			0.005		
Gate Inductance	L_G			1.84		
Gate Resistance	R_G			0.90		Ω

3. Pulse Test: pulse width $\leq 300\ \mu\text{s}$, duty cycle $\leq 2\%$.
4. Switching characteristics are independent of operating junction temperatures.

NTMFS4841NH

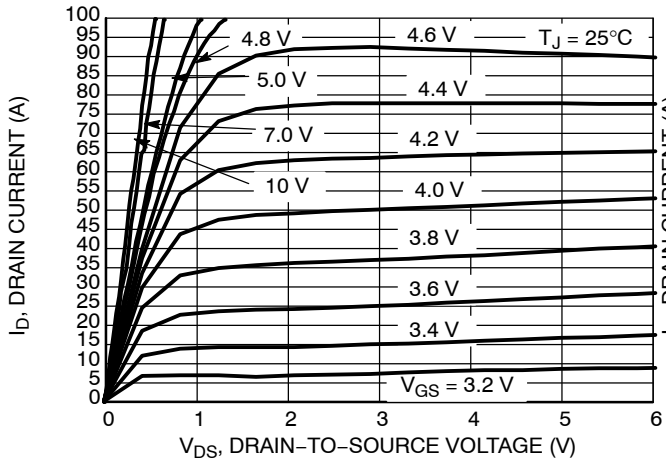

Figure 1. On-Region Characteristics

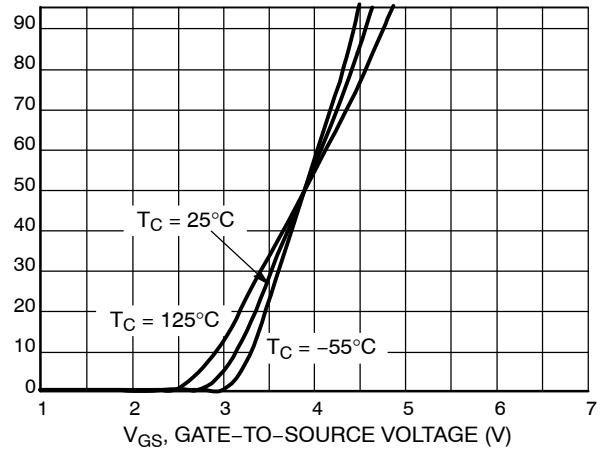

Figure 2. Transfer Characteristics

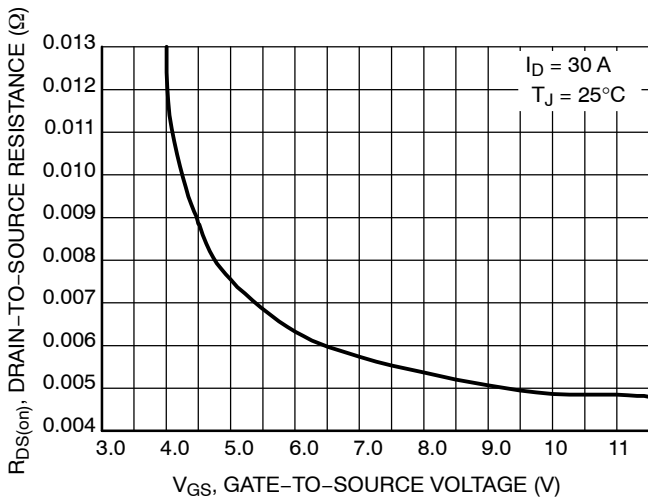

Figure 3. On-Resistance versus Gate-to-Source Voltage

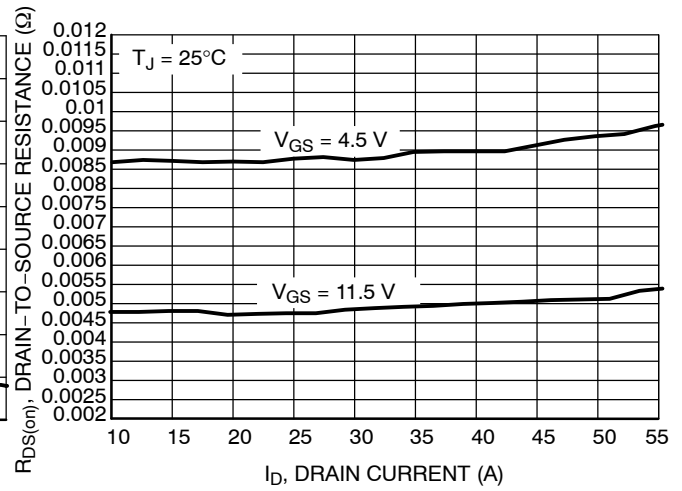

Figure 4. On-Resistance versus Drain Current and Gate Voltage

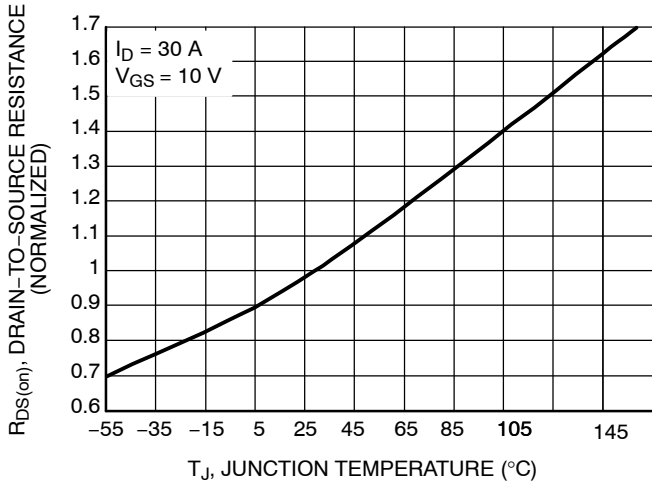

Figure 5. On-Resistance Variation with Temperature

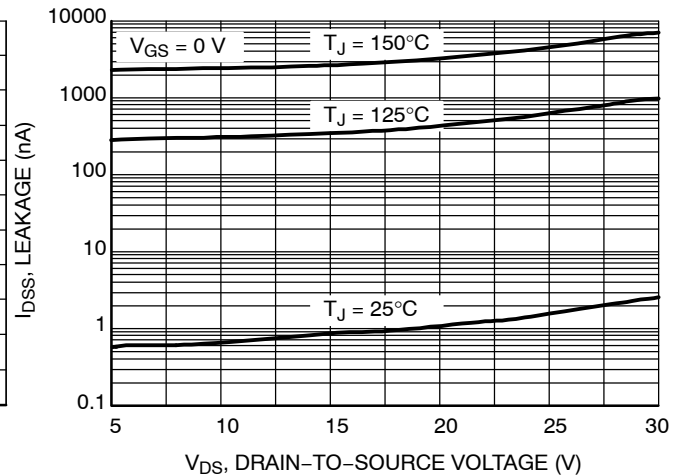

Figure 6. Drain-to-Source Leakage Current versus Voltage

NTMFS4841NH

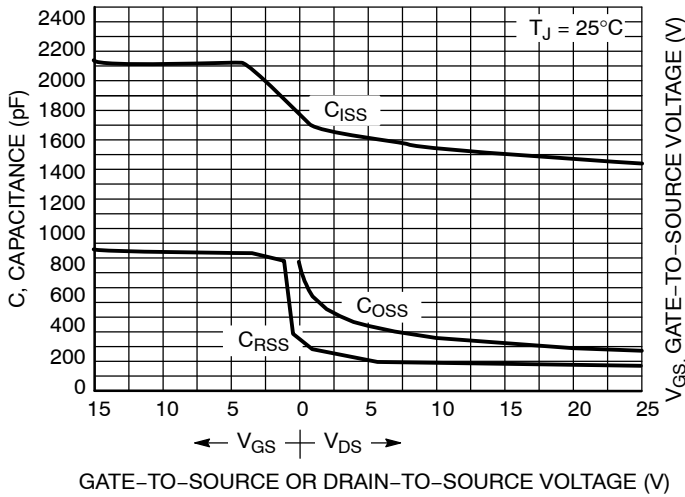

Figure 7. Capacitance Variation

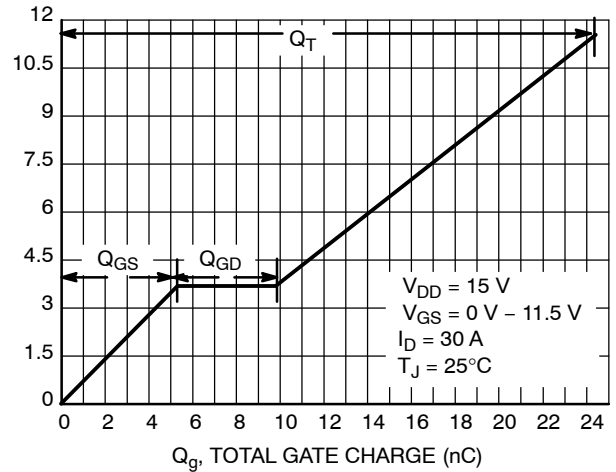

Figure 8. Gate-to-Source and Drain-to-Source Voltage vs. Total Gate Charge

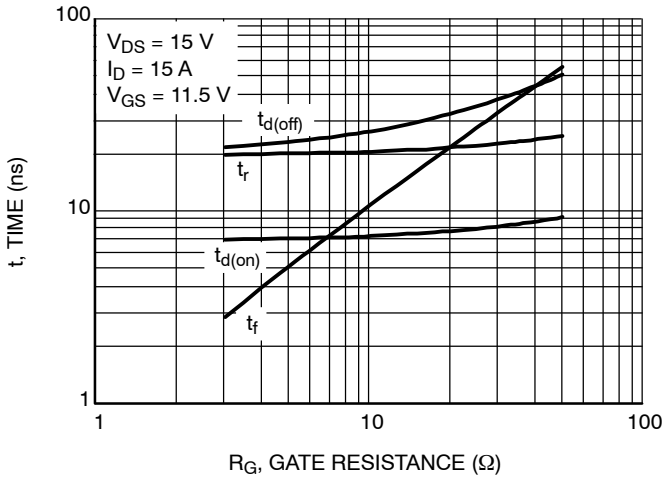

Figure 9. Resistive Switching Time Variation versus Gate Resistance

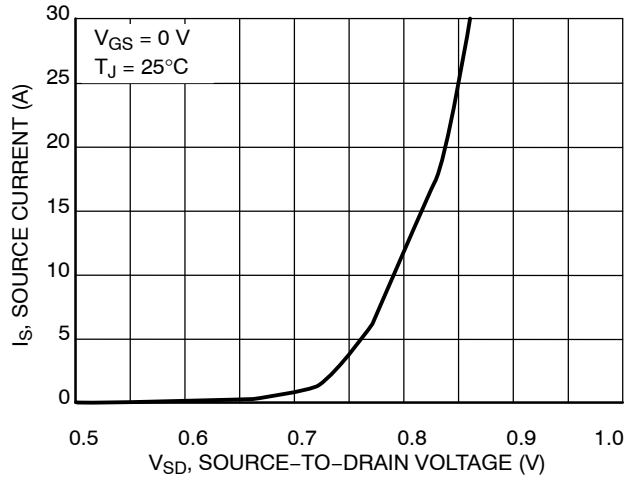

Figure 10. Diode Forward Voltage versus Current

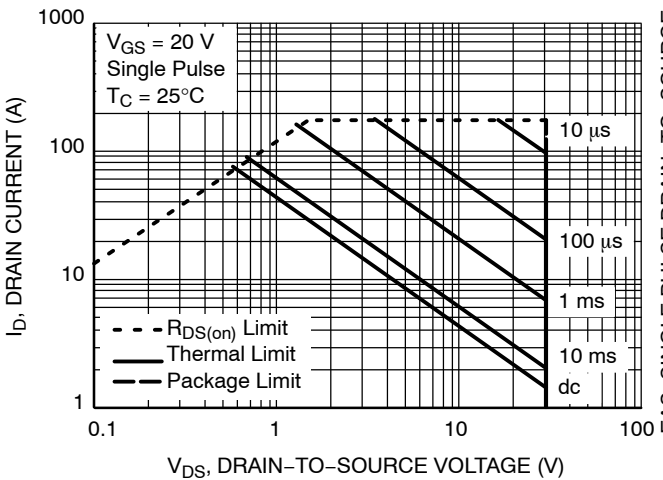

Figure 11. Maximum Rated Forward Biased Safe Operating Area

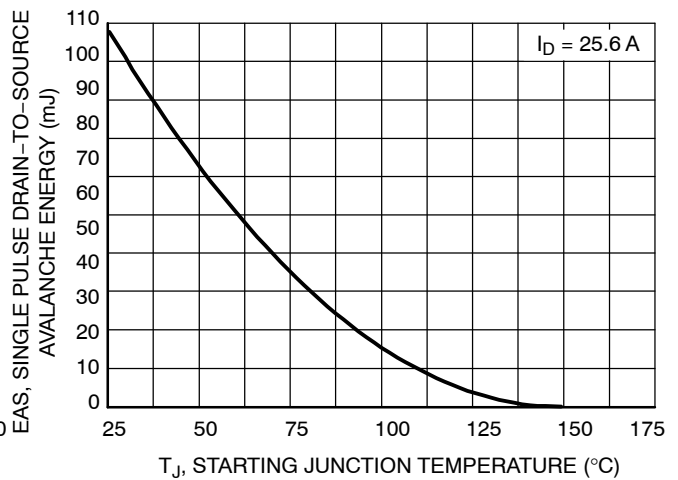

Figure 12. Maximum Avalanche Energy versus Starting Junction Temperature

NTMFS4841NH

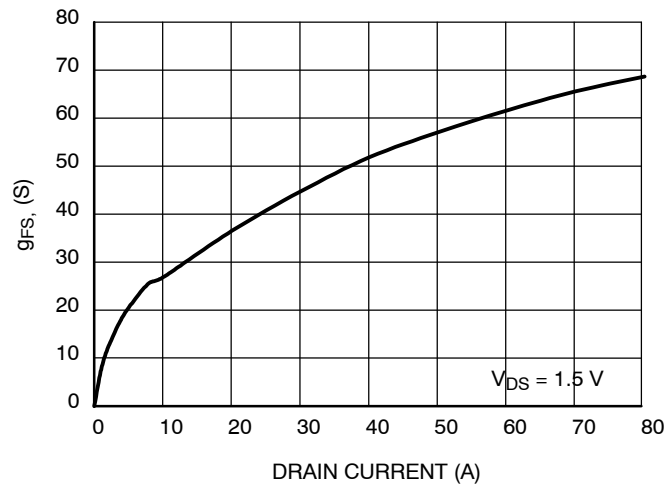

Figure 13. G_{FS} versus Drain Current

NTMFS4841NH

PACKAGE DIMENSIONS

DFN5 5x6, 1.27P
(SO-8FL)
CASE 488AA-01
ISSUE D

NOTES:

1. DIMENSIONING AND TOLERANCING PER ASME Y14.5M, 1994.
2. CONTROLLING DIMENSION: MILLIMETER.
3. DIMENSION D1 AND E1 DO NOT INCLUDE MOLD FLASH PROTRUSIONS OR GATE BURRS.

DIM	MILLIMETERS		
	MIN	NOM	MAX
A	0.90	1.00	1.10
A1	0.00	---	0.05
b	0.33	0.41	0.51
c	0.23	0.28	0.33
D	5.15 BSC		
D1	4.50	4.90	5.10
D2	3.50	---	4.22
E	6.15 BSC		
E1	5.50	5.80	6.10
E2	3.45	---	4.30
e	1.27 BSC		
G	0.51	0.61	0.71
K	0.51	---	---
L	0.51	0.61	0.71
L1	0.05	0.17	0.20
M	3.00	3.40	3.80
θ	0°	---	12°

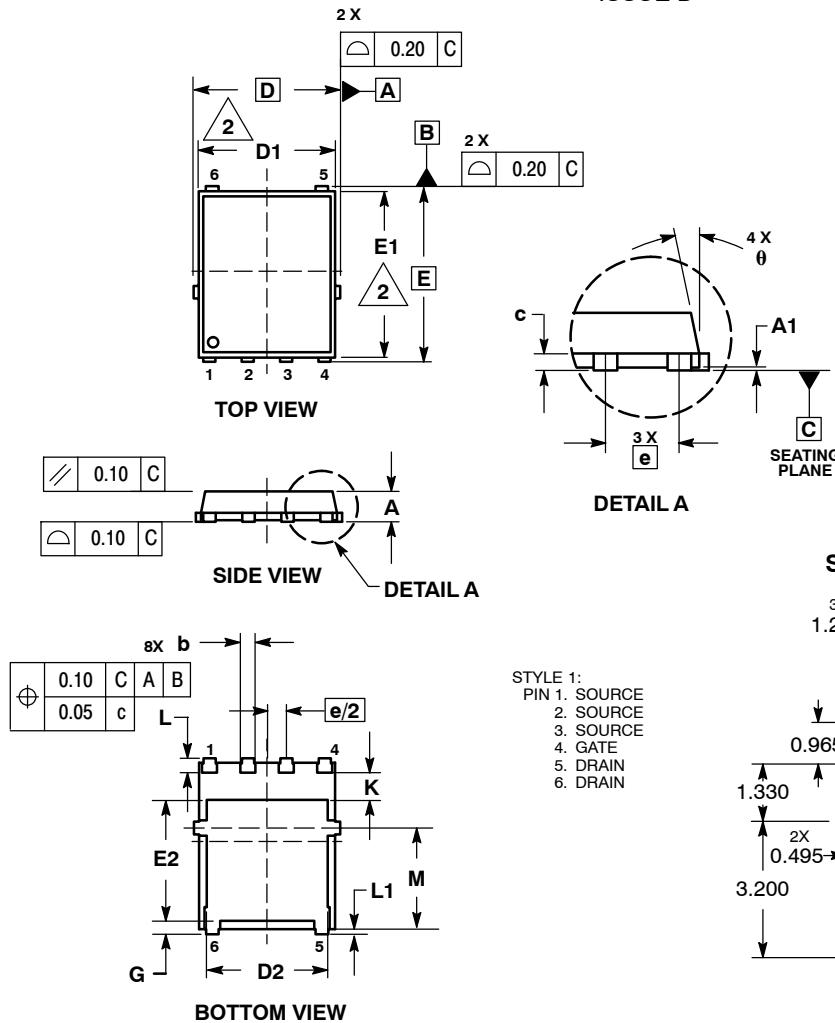

- STYLE 1:
PIN 1. SOURCE
2. SOURCE
3. SOURCE
4. GATE
5. DRAIN
6. DRAIN

SOLDERING FOOTPRINT*

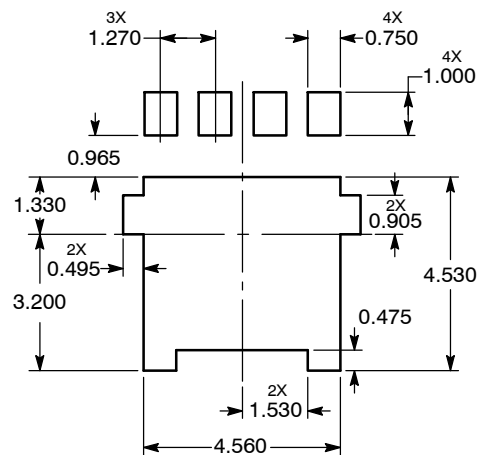

*For additional information on our Pb-Free strategy and soldering details, please download the ON Semiconductor Soldering and Mounting Techniques Reference Manual, SOLDERRM/D.

ON Semiconductor and are registered trademarks of Semiconductor Components Industries, LLC (SCILLC). SCILLC reserves the right to make changes without further notice to any products herein. SCILLC makes no warranty, representation or guarantee regarding the suitability of its products for any particular purpose, nor does SCILLC assume any liability arising out of the application or use of any product or circuit, and specifically disclaims any and all liability, including without limitation special, consequential or incidental damages. "Typical" parameters which may be provided in SCILLC data sheets and/or specifications can and do vary in different applications and actual performance may vary over time. All operating parameters, including "Typicals" must be validated for each customer application by customer's technical experts. SCILLC does not convey any license under its patent rights nor the rights of others. SCILLC products are not designed, intended, or authorized for use as components in systems intended for surgical implant into the body, or other applications intended to support or sustain life, or for any other application in which the failure of the SCILLC product could create a situation where personal injury or death may occur. Should Buyer purchase or use SCILLC products for any such unintended or unauthorized application, Buyer shall indemnify and hold SCILLC and its officers, employees, subsidiaries, affiliates, and distributors harmless against all claims, costs, damages, and expenses, and reasonable attorney fees arising out of, directly or indirectly, any claim of personal injury or death associated with such unintended or unauthorized use, even if such claim alleges that SCILLC was negligent regarding the design or manufacture of the part. SCILLC is an Equal Opportunity/Affirmative Action Employer. This literature is subject to all applicable copyright laws and is not for resale in any manner.

PUBLICATION ORDERING INFORMATION

LITERATURE FULFILLMENT:
Literature Distribution Center for ON Semiconductor
P.O. Box 5163, Denver, Colorado 80217 USA
Phone: 303-675-2175 or 800-344-3860 Toll Free USA/Canada
Fax: 303-675-2176 or 800-344-3867 Toll Free USA/Canada
Email: orderlit@onsemi.com

N. American Technical Support: 800-282-9855 Toll Free
USA/Canada
Europe, Middle East and Africa Technical Support:
Phone: 421 33 790 2910
Japan Customer Focus Center
Phone: 81-3-5773-3850

ON Semiconductor Website: www.onsemi.com
Order Literature: <http://www.onsemi.com/orderlit>

For additional information, please contact your local Sales Representative