

Features

- Formerly *JW.Miller* model
- High resistance to heat and humidity
- Resistance to mechanical shock and pressure
- Accurate dimensions for automatic surface mounting
- Wide inductance range (1.0 nH to 1000 μH)
- RoHS compliant*

Applications

- DC/DC converters
- Power supplies
- General use

PM1210 & PM1812 Series SMT Chip Inductors

General Specifications

Temperature Rise	20 °C max.
Ambient Temperature	80 °C max.
Operating Temperature.....	-40 °C to +100 °C
Storage Temperature.....	-40 °C to +100 °C
Resistance to Soldering Heat	
PM1210.....	260 °C, 5 seconds
PM1812.....	245 °C, 5 seconds

Materials

Ferrite Core	
PM1210.....	All
PM1812.....	All
Coil Type.....	Copper wire
Enclosure.....	Epoxy resin
Terminal	Sn

Product Dimensions

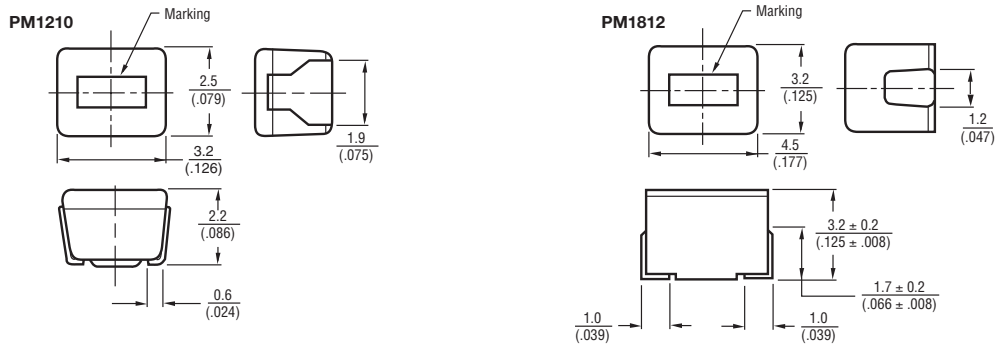

Recommended Land Pattern Dimensions

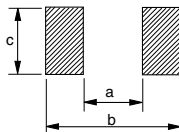

Model	a	b	c
PM1210	$\frac{1.6 \text{ to } 2.0}{(.063 \text{ to } .079)}$	$\frac{4.0 \text{ to } 4.6}{(.157 \text{ to } .181)}$	$\frac{1.9 \text{ to } 2.4}{(.075 \text{ to } .094)}$
PM1812	$\frac{2.4 \text{ to } 2.6}{(.094 \text{ to } .102)}$	$\frac{5.5 \text{ to } 6.0}{(.217 \text{ to } .236)}$	$\frac{2.0 \text{ to } 3.0}{(.079 \text{ to } .118)}$

DIMENSIONS: $\frac{\text{MM}}{\text{(INCHES)}}$

*RoHS Directive 2002/95/EC Jan 27 2003 including Annex.
 Specifications are subject to change without notice.
 Customers should verify actual device performance in their specific applications.

PM1210 & PM1812 Series SMT Chip Inductors

BOURNS®

Packaging Specifications

PM1210 Series

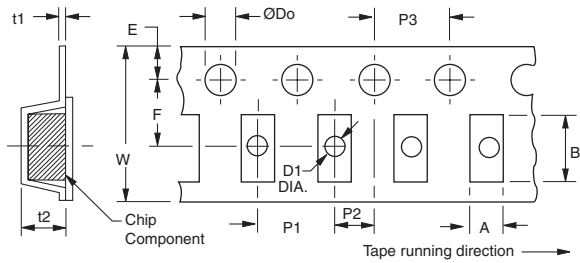

PM1812 Series

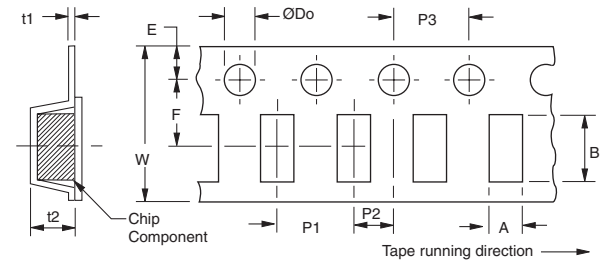

Model	A	B	W	F	E	P1	P2	P3	øD0	øD1	t1	t2
PM1210	$\frac{2.80}{(.110)}$	$\frac{3.60}{(.142)}$	$\frac{8.00}{(.315)}$	$\frac{3.50}{(.138)}$	$\frac{1.75}{(.069)}$	$\frac{4.00}{(.157)}$	$\frac{2.00}{(.079)}$	$\frac{4.00}{(.157)}$	$\frac{1.50}{(.059)}$	—	$\frac{0.25}{(.010)}$	$\frac{2.40}{(.094)}$
PM1812	$\frac{3.60}{(.142)}$	$\frac{4.90}{(.193)}$	$\frac{12.00}{(.472)}$	$\frac{5.50}{(.217)}$	$\frac{1.75}{(.069)}$	$\frac{8.00}{(.315)}$	$\frac{2.00}{(.079)}$	$\frac{4.00}{(.157)}$	$\frac{1.50}{(.059)}$	—	$\frac{0.30}{(.012)}$	$\frac{3.50}{(.138)}$

Reel Dimensions

Model	A	B	C	D	E	W
PM1210	$\frac{178}{(7.008)}$	60 min.	$\frac{13}{(.512)}$	$\frac{21}{(.827)}$	$\frac{2}{(.079)}$	$\frac{9}{(.354)}$
PM1812	$\frac{178}{(7.008)}$	60 min.	$\frac{13}{(.512)}$	$\frac{21}{(.827)}$	$\frac{2}{(.079)}$	$\frac{13}{(.512)}$

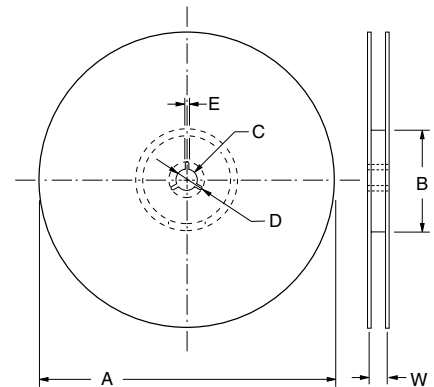

Packaging

Model	Quantity	Weight
PM1210	2000 pcs.	190 g
PM1812	500 pcs.	100 g

DIMENSIONS: $\frac{\text{MM}}{\text{(INCHES)}}$

Soldering Profiles

PM1210 Series

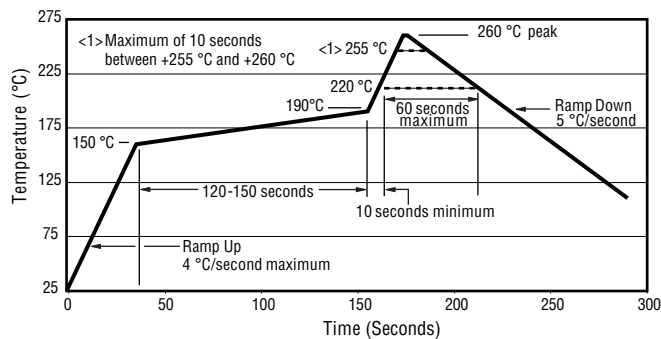

PM1812 Series

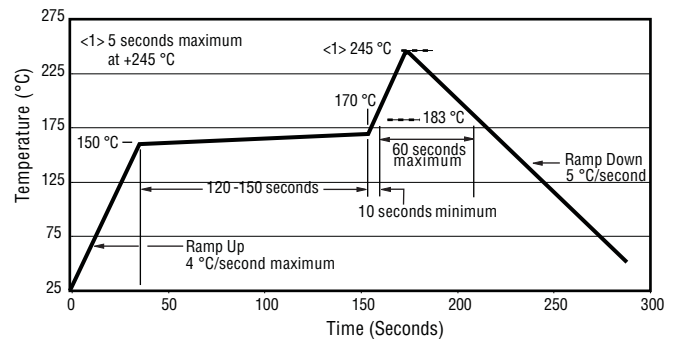

Specifications are subject to change without notice. Customers should verify actual device performance in their specific applications.

PM1210 & PM1812 Series SMT Chip Inductors

BOURNS®

PM1210 Series

RoHS Compliant 1210 Size Part Number	Inductance μ H	Tolerance	Q min.	Test Frequency MHz	SRF min. MHz	RDC ohms max.	IDC mA max.
PM1210-1R0J-RC	1.0	$\pm 5\%$	30	7.96	115	0.69	230
PM1210-1R2J-RC	1.2	$\pm 5\%$	30	7.96	100	0.75	215
PM1210-1R5J-RC	1.5	$\pm 5\%$	30	7.96	90	0.75	210
PM1210-1R8J-RC	1.8	$\pm 5\%$	30	7.96	85	0.82	200
PM1210-2R2J-RC	2.2	$\pm 5\%$	30	7.96	80	0.95	190
PM1210-2R7J-RC	2.7	$\pm 5\%$	30	7.96	75	1.1	180
PM1210-3R3J-RC	3.3	$\pm 5\%$	30	7.96	65	1.2	180
PM1210-3R9J-RC	3.9	$\pm 5\%$	30	7.96	60	1.3	175
PM1210-4R7J-RC	4.7	$\pm 5\%$	30	7.96	55	1.5	165
PM1210-5R6J-RC	5.6	$\pm 5\%$	30	7.96	50	1.6	160
PM1210-6R8J-RC	6.8	$\pm 5\%$	30	7.96	45	1.8	150
PM1210-8R2J-RC	8.2	$\pm 5\%$	30	7.96	40	2.0	140
PM1210-100J-RC	10	$\pm 5\%$	30	2.52	36	2.1	140
PM1210-120J-RC	12	$\pm 5\%$	30	2.52	33	2.5	125
PM1210-150J-RC	15	$\pm 5\%$	30	2.52	30	2.8	120
PM1210-180J-RC	18	$\pm 5\%$	30	2.52	27	3.3	110
PM1210-220J-RC	22	$\pm 5\%$	30	2.52	25	3.7	105
PM1210-270J-RC	27	$\pm 5\%$	30	2.52	22	5.0	90
PM1210-330J-RC	33	$\pm 5\%$	30	2.52	20	5.6	85
PM1210-390J-RC	39	$\pm 5\%$	30	2.52	20	6.4	80
PM1210-470J-RC	47	$\pm 5\%$	30	2.52	15	7.0	75
PM1210-560J-RC	56	$\pm 5\%$	30	2.52	15	8.0	70
PM1210-680J-RC	68	$\pm 5\%$	30	2.52	15	9.0	65
PM1210-820J-RC	82	$\pm 5\%$	30	2.52	11	10	60
PM1210-101J-RC	100	$\pm 5\%$	20	0.796	10	10	60
PM1210-121J-RC	120	$\pm 5\%$	20	0.796	10	11	55
PM1210-151J-RC	150	$\pm 5\%$	20	0.796	8	15	50
PM1210-181J-RC	180	$\pm 5\%$	20	0.796	7	17	50
PM1210-221J-RC	220	$\pm 5\%$	20	0.796	7	21	45

PM1210 & PM1812 Series SMT Chip Inductors

BOURNS®

PM1812 Series

RoHS Compliant 1812 Size Part Number	Inductance µH	Tolerance	Q min.	Test Freq. MHz	SRF min. MHz	RDC ohms max.	IDC mA max.
PM1812-R10K-RC	0.10	±10 %	35	25.2	300	0.18	800
PM1812-R12K-RC	0.12	±10 %	35	25.2	280	0.2	770
PM1812-R15K-RC	0.15	±10 %	35	25.2	250	0.22	730
PM1812-R18K-RC	0.18	±10 %	35	25.2	220	0.24	700
PM1812-R22K-RC	0.22	±10 %	40	25.2	200	0.25	665
PM1812-R27K-RC	0.27	±10 %	40	25.2	180	0.26	635
PM1812-R33K-RC	0.33	±10 %	40	25.2	165	0.28	605
PM1812-R39K-RC	0.39	±10 %	40	25.2	150	0.30	575
PM1812-R47K-RC	0.47	±10 %	40	25.2	145	0.32	545
PM1812-R56K-RC	0.56	±10 %	40	25.2	140	0.36	520
PM1812-R68K-RC	0.68	±10 %	40	25.2	135	0.40	500
PM1812-R82K-RC	0.82	±10 %	40	25.2	130	0.45	475
PM1812-1R0J-RC	1.0	±5 %	50	7.96	100	0.50	450
PM1812-1R2J-RC	1.2	±5 %	50	7.96	80	0.55	430
PM1812-1R5J-RC	1.5	±5 %	50	7.96	70	0.60	410
PM1812-1R8J-RC	1.8	±5 %	50	7.96	60	0.65	390
PM1812-2R2J-RC	2.2	±5 %	50	7.96	55	0.70	380
PM1812-2R7J-RC	2.7	±5 %	50	7.96	50	0.75	370
PM1812-3R3J-RC	3.3	±5 %	50	7.96	45	0.80	355
PM1812-3R9J-RC	3.9	±5 %	50	7.96	40	0.90	330
PM1812-4R7J-RC	4.7	±5 %	50	7.96	35	1.00	315
PM1812-5R6J-RC	5.6	±5 %	50	7.96	33	1.10	300
PM1812-6R8J-RC	6.8	±5 %	50	7.96	27	1.2	285
PM1812-8R2J-RC	8.2	±5 %	50	7.96	25	1.4	270
PM1812-100J-RC	10	±5 %	50	2.52	20	1.6	250
PM1812-120J-RC	12	±5 %	50	2.52	18	2	225
PM1812-150J-RC	15	±5 %	50	2.52	17	2.5	200
PM1812-180J-RC	18	±5 %	50	2.52	15	2.8	190
PM1812-220J-RC	22	±5 %	50	2.52	13	3.2	180
PM1812-270J-RC	27	±5 %	50	2.52	12	3.6	170
PM1812-330J-RC	33	±5 %	50	2.52	11	4	160
PM1812-390J-RC	39	±5 %	50	2.52	10	4.5	150
PM1812-470J-RC	47	±5 %	50	2.52	10	5	140
PM1812-560J-RC	56	±5 %	50	2.52	9	5.5	135
PM1812-680J-RC	68	±5 %	50	2.52	9	6	130
PM1812-820J-RC	82	±5 %	50	2.52	8	7	120
PM1812-101J-RC	100	±5 %	40	2.52	8	8	110
PM1812-121J-RC	120	±5 %	40	0.796	6	8	110
PM1812-151J-RC	150	±5 %	40	0.796	5	9	105
PM1812-181J-RC	180	±5 %	40	0.796	5	9.5	102
PM1812-221J-RC	220	±5 %	40	0.796	4	10	100
PM1812-271J-RC	270	±5 %	40	0.796	4	12	92
PM1812-331J-RC	330	±5 %	40	0.796	3.5	14	85
PM1812-391J-RC	390	±5 %	40	0.796	3	18	80
PM1812-471J-RC	470	±5 %	40	0.796	3	26	62
PM1812-561J-RC	560	±5 %	30	0.796	3	30	50
PM1812-681J-RC	680	±5 %	30	0.796	3	30	50
PM1812-821J-RC	820	±5 %	30	0.796	2.5	35	30
PM1812-102J-RC	1000	±5 %	30	0.252	2.5	40	30

REV. 07/10

Specifications are subject to change without notice.

Customers should verify actual device performance in their specific applications.