

# Agilent E4980A Precision LCR Meter

20 Hz to 2 MHz

Data Sheet

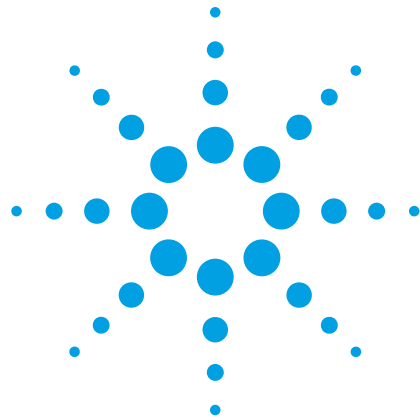

Fully compliant to  
LXI Class C specification



**Agilent Technologies**

## Definitions

All specifications apply to the conditions of a 0 to 55 °C temperature range, unless otherwise stated, and 30 minutes after the instrument has been turned on.

**Specifications (spec.):** Warranted performance. Specifications include guardbands to account for the expected statistical performance distribution, measurement uncertainties, and changes in performance due to environmental conditions.

Supplemental information is provided as information that is useful in operating the instrument, but is not covered by the product warranty. This information is classified as either typical or nominal.

**Typical (typ.):** Expected performance of an average unit without taking guardbands into account.

**Nominal (nom.):** A general descriptive term that does not imply a level of performance.

## How to Use Tables

When measurement conditions fall under multiple categories in a table, apply the best value.

For example, basic accuracy  $A_b$  is 0.10% under the following conditions:

Measurement time mode	SHORT
Test frequency	125 Hz
Test signal voltage	0.3 Vrms

# Basic Specifications

## Measurement functions

### Measurement parameters

- Cp-D, Cp-Q, Cp-G, Cp-Rp
- Cs-D, Cs-Q, Cs-Rs
- Lp-D, Lp-Q, Lp-G, Lp-Rp, Lp-Rdc<sup>1</sup>
- Ls-D, Ls-Q, Ls-Rs, Ls-Rdc<sup>1</sup>
- R-X
- Z- $\theta$ d, Z- $\theta$ r
- G-B
- Y- $\theta$ d, Y- $\theta$ r
- Vdc-Idc<sup>1</sup>

### Definitions

<b>Cp</b>	Capacitance value measured with parallel-equivalent circuit model
<b>Cs</b>	Capacitance value measured with series-equivalent circuit model
<b>Lp</b>	Inductance value measured with parallel-equivalent circuit model
<b>Ls</b>	Inductance value measured with series-equivalent circuit model
<b>D</b>	Dissipation factor
<b>Q</b>	Quality factor (inverse of D)
<b>G</b>	Equivalent parallel conductance measured with parallel-equivalent circuit model
<b>Rp</b>	Equivalent parallel resistance measured with parallel-equivalent circuit model
<b>Rs</b>	Equivalent series resistance measured with series-equivalent circuit model
<b>Rdc</b>	Direct-current resistance
<b>R</b>	Resistance
<b>X</b>	Reactance
<b>Z</b>	Impedance
<b>Y</b>	Admittance
<b><math>\theta</math>d</b>	Phase angle of impedance/admittance (degree)
<b><math>\theta</math>r</b>	Phase angle of impedance/admittance (radian)
<b>B</b>	Susceptance
<b>Vdc</b>	Direct-current voltage
<b>Idc</b>	Direct-current electricity

**Deviation measurement function:** Deviation from reference value and percentage of deviation from reference value can be output as the result.

**Equivalent circuits for measurement:** Parallel, Series

**Impedance range selection:** Auto (auto range mode), manual (hold range mode)

**Trigger mode:** Internal trigger (INT), manual trigger (MAN), external trigger (EXT), GPIB trigger (BUS)

---

1. Option E4980A-001 is required.

**Table 1. Trigger delay time**

<b>Range</b>	0 s - 999 s
<b>Resolution</b>	100 $\mu$ s (0 s - 100 s) 1 ms (100 s - 999 s)

**Table 2. Step delay time**

<b>Range</b>	0 s - 999 s
<b>Resolution</b>	100 $\mu$ s (0 s - 100 s) 1 ms (100 s - 999 s)

**Measurement terminal:** Four-terminal pair

**Test cable length:** 0 m, 1 m, 2 m, 4 m

**Measurement time modes:** Short mode, medium mode, long mode.

**Table 3. Averaging**

<b>Range</b>	1 - 256 measurements
<b>Resolution</b>	1

## Test signal

**Table 4. Test frequencies**

<b>Test frequencies</b>	20 Hz - 2 MHz
<b>Resolution</b>	0.01 Hz (20 Hz - 99.99 Hz) 0.1 Hz (100 Hz - 999.9 Hz) 1 Hz (1 kHz - 9.999 kHz) 10 Hz (10 kHz - 99.99 kHz) 100 Hz (100 kHz - 999.9 kHz) 1 kHz (1 MHz - 2 MHz)
<b>Measurement accuracy</b>	$\pm 0.01\%$

**Table 5. Test signal modes**

<b>Normal</b>	Program selected voltage or current at the measurement terminals when they are opened or short-circuited, respectively.
<b>Constant</b>	Maintains selected voltage or current at the device under test (DUT) independently of changes in impedance of DUT.

## Signal level

**Table 6. Test signal voltage**

<b>Range</b>	0 Vrms - 2.0 Vrms		
<b>Resolution</b>	100 $\mu$ Vrms (0 Vrms - 0.2 Vrms)		
	200 $\mu$ Vrms (0.2 Vrms - 0.5 Vrms)		
	500 $\mu$ Vrms (0.5 Vrms - 1 Vrms)		
	1 mVrms (1 Vrms - 2 Vrms)		
<b>Accuracy</b>	Normal	$\pm(10\% + 1 \text{ mVrms})$	Test frequency $\leq 1 \text{ MHz}$ : spec. Test frequency $> 1 \text{ MHz}$ : typ.
	Constant <sup>1</sup>	$\pm(6\% + 1 \text{ mVrms})$	Test frequency $\leq 1 \text{ MHz}$ : spec. Test frequency $> 1 \text{ MHz}$ : typ.

**Table 7. Test signal current**

<b>Range</b>	0 Arms - 20 mArms		
<b>Resolution</b>	1 $\mu$ Arms (0 Arms - 2 mArms)		
	2 $\mu$ Arms (2 mArms - 5 mArms)		
	5 $\mu$ Arms (5 mArms - 10 mArms)		
	10 $\mu$ Arms (10 mArms - 20 mArms)		
<b>Accuracy</b>	Normal	$\pm(10\% + 10 \mu\text{Arms})$	Test frequency $\leq 1 \text{ MHz}$ : spec. Test frequency $> 1 \text{ MHz}$ : typ.
	Constant <sup>1</sup>	$\pm(6\% + 10 \mu\text{Arms})$	Test frequency $\leq 1 \text{ MHz}$ : spec. Test frequency $> 1 \text{ MHz}$ : typ.

**Output impedance:** 100  $\Omega$  (nominal)

### Test signal level monitor function

- Test signal voltage and test signal current can be monitored.
- Level monitor accuracy:

**Table 8. Test signal voltage monitor accuracy (Vac)**

Test signal voltage <sup>2</sup>	Test frequency	Specification
5 mVrms - 2 Vrms	$\leq 1 \text{ MHz}$	$\pm (3\% \text{ of reading value} + 0.5 \text{ mVrms})$
	$> 1 \text{ MHz}$	$\pm (6\% \text{ of reading value} + 1 \text{ mVrms})$

**Table 9. Test signal current monitor accuracy (Iac)**

Test signal current <sup>2</sup>	Test frequency	Specification
50 $\mu$ Arms - 20 mArms	$\leq 1 \text{ MHz}$	$\pm (3\% \text{ of reading value} + 5 \mu\text{Arms})$
	$> 1 \text{ MHz}$	$\pm (6\% \text{ of reading value} + 10 \mu\text{Arms})$

1. When auto level control function is on.  
2. This is not an output value but rather a displayed test signal level.

## Measurement display ranges

Table 10 shows the range of measured value that can be displayed on the screen. For the effective measurement ranges, refer to Figure 1. impedance measurement accuracy example .

**Table 10. Allowable display ranges for measured values**

Parameter	Measurement display range
Cs, Cp	$\pm 1.000000$ aF to 999.9999 EF
Ls, Lp	$\pm 1.000000$ aH to 999.9999 EH
D	$\pm 0.000001$ to 9.999999
Q	$\pm 0.01$ to 99999.99
R, Rs, Rp, X, Z, Rdc	$\pm 1.000000$ a $\Omega$ to 999.9999 E $\Omega$
G, B, Y	$\pm 1.000000$ aS to 999.9999 ES
Vdc	$\pm 1.000000$ aV to 999.9999 EV
Idc	$\pm 1.000000$ aA to 999.9999 EA
$\theta_r$	$\pm 1.000000$ arad to 3.141593 rad
$\theta_d$	$\pm 0.0001$ deg to 180.0000 deg
$\Delta\%$	$\pm 0.0001$ % to 999.9999 %

a:  $1 \times 10^{-18}$ , E:  $1 \times 10^{18}$

## Absolute measurement accuracy

The following equations are used to calculate absolute accuracy.

**Absolute accuracy Aa of |Z|, |Y|, L, C, R, X, G, B (L, C, X, and B accuracies apply when  $Dx \leq 0.1$ , R and G accuracies apply when  $Qx \leq 0.1$ )**

Equation 1.  $Aa = Ae + Acal$

Aa Absolute accuracy (% of reading value)

Ae Relative accuracy (% of reading value)

Acal Calibration accuracy (%)

where G accuracy is applied only to G-B measurements.

### D accuracy (when $Dx \leq 0.1$ )

Equation 2.  $De + \theta cal$

Dx Measured D value

De Relative accuracy of D

$\theta cal$  Calibration accuracy of  $\theta$  (radian)

### Q accuracy (When $Qx \times Da < 1$ )

Equation 3.  $\pm \frac{(Qx^2 \times Da)}{(1 \mp Qx \times Da)}$

Qx Measured Q value

Da Absolute accuracy of D

### $\theta$ accuracy

Equation 4.  $\theta e + \theta cal$

$\theta e$  Relative accuracy of  $\theta$  (degree)

$\theta cal$  Calibration accuracy of  $\theta$  (degree)

**G accuracy (when  $D_x \leq 0.1$ )**

Equation 5. 
$$\frac{B_x + D_a}{B_x} = \frac{1}{2\pi f L_x} \quad (S)$$

$D_x$	Measured D value
$B_x$	Measured B value (S)
$D_a$	Absolute accuracy of D
$f$	Test frequency (Hz)
$C_x$	Measured C value (F)
$L_x$	Measured L value (H)

where the accuracy of G is applied to Cp-G measurements.

**Absolute accuracy of  $R_p$  (when  $D_x \leq 0.1$ )**

Equation 6. 
$$\pm \frac{R_{px} \times D_a}{D_x \mp D_a} \quad (\Omega)$$

$R_{px}$	Measured $R_p$ value ( $\Omega$ )
$D_x$	Measured D value
$D_a$	Absolute accuracy of D

**Absolute accuracy of  $R_s$  (when  $D_x \leq 0.1$ )**

Equation 7. 
$$X_x \times D_a \quad (\Omega)$$

$$X_x = \frac{1}{2\pi f C_x} = 2\pi f L_x$$

$D_x$	Measured D value
$X_x$	Measured X value ( $\Omega$ )
$D_a$	Absolute accuracy of D
$f$	Test frequency (Hz)
$C_x$	Measured C value (F)
$L_x$	Measured L value (H)



## Relative accuracy

Relative accuracy includes stability, temperature coefficient, linearity, repeatability, and calibration interpolation error. Relative accuracy is specified when all of the following conditions are satisfied:

- Warm-up time: 30 minutes
- Test cable length: 0 m, 1 m, 2 m, or 4 m (Agilent 16047A/B/D/E)
- A "Signal Source Overload" warning does not appear.  
When the test signal current exceeds a value in table 11 below, a "Signal Source Overload" warning appears.

**Table 11.**

Test signal voltage	Test frequency	Condition <sup>1</sup>
≤ 2 Vrms	–	–
> 2 Vrms	≤ 1 MHz	the smaller value of either 110 mA or 130 mA - 0.0015 × Vac × (Fm / 1 MHz) × (L_cable + 0.5)
	> 1 MHz	70 mA - 0.0015 × Vac × (Fm / 1 MHz) × (L_cable + 0.5)
Vac [V]	Test signal voltage	
Fm [Hz]	Test frequency	
L_cable [m]	Cable length	

- OPEN and SHORT corrections have been performed.
- Bias current isolation: Off
- The DC bias current does not exceed a set value within each range of the DC bias current
- The optimum impedance range is selected by matching the impedance of DUT to the effective measuring range.
- Under an AC magnetic field, the following equation is applied to the measurement accuracy.

$$A \times (1 + B \times (2 + 0.5 / Vs))$$

Where

A: Absolute accuracy

B: Magnetic flux density [Gauss]

Vs: Test signal voltage level [Volts]

### **|Z|, |Y|, L, C, R, X, G, and B accuracy (L, C, X, and B accuracies apply when $D_x \leq 0.1$ , R and G accuracies apply $Q_x \leq 0.1$ )**

Relative accuracy Ae is given as:

$$\text{Equation 8.} \quad Ae = [Ab + Zs / |Zm| \times 100 + Yo \times |Zm| \times 100] \times Kt$$

Zm Impedance of DUT

Ab Basic accuracy

Zs Short offset

Yo Open offset

Kt Temperature coefficient

### **D accuracy**

D accuracy De is given as

- when  $D_x \leq 0.1$

$$\text{Equation 9.} \quad De = \pm Ae / 100$$

Dx Measured D value

Ae Relative accuracies of |Z|, |Y|, L, C, R, X, G, and B

- when  $D_x > 0.1$ , multiply De by (1 + Dx)

1. When the calculation result is a negative value, 0 A is applied.

**Q accuracy (when  $Q \times De < 1$ )**Q accuracy  $Q_e$  is given as:

$$\text{Equation 10.} \quad Q_e = \pm \frac{(Q_x^2 \times De)}{(1 \mp Q_x \times De)}$$

$Q_x$  Measured Q value  
 $De$  Relative D accuracy

 **$\theta$  accuracy** $\theta$  accuracy  $\theta_e$  is given as:

$$\text{Equation 11.} \quad \theta_e = \frac{180 \times Ae}{\pi \times 100} \quad (\text{deg})$$

$A_e$  Relative accuracies of  $|Z|$ ,  $|Y|$ , L, C, R, X, G, and B

**G accuracy (when  $Dx \leq 0.1$ )**G accuracy  $G_e$  is given as:

$$\text{Equation 12.} \quad G_e = B_x \times De \quad (S)$$

$$B_x = 2\pi f C_x = \frac{1}{2\pi f L_x}$$

$G_e$  Relative G accuracy  
 $D_x$  Measured D value  
 $B_x$  Measured B value  
 $De$  Relative D accuracy  
 $f$  Test frequency  
 $C_x$  Measured C value (F)  
 $L_x$  Measured L value (H)

 **$R_p$  accuracy (when  $Dx \leq 0.1$ )** $R_p$  accuracy  $R_{pe}$  is given as:

$$\text{Equation 13.} \quad R_{pe} = \pm \frac{R_{px} \times De}{D_x \mp De} \quad (\Omega)$$

$R_{pe}$  Relative  $R_p$  accuracy  
 $R_{px}$  Measured  $R_p$  value ( $\Omega$ )  
 $D_x$  Measured D value  
 $De$  Relative D accuracy

 **$R_s$  accuracy (when  $Dx \leq 0.1$ )** $R_s$  accuracy  $R_{se}$  is given as:

$$\text{Equation 14.} \quad R_{se} = X_x \times De \quad (\Omega)$$

$$X_x = \frac{1}{2\pi f C_x} = 2\pi f L_x$$

$R_{se}$  Relative  $R_s$  accuracy  
 $D_x$  Measured D value  
 $X_x$  Measured X value ( $\Omega$ )  
 $De$  Relative D accuracy  
 $f$  Test frequency (Hz)  
 $C_x$  Measured C value (F)  
 $L_x$  Measured L value (H)

## Example of C-D accuracy calculation

### Measurement conditions

**Test Frequency:** 1 kHz  
**Measured C value:** 100 nF  
**Test signal voltage:** 1 Vrms  
**Measurement time mode:** Medium  
**Measurement temperature:** 23 °C

$$A_b = 0.05\%$$

$$|Z_m| = 1 / (2\pi \times 1 \times 10^3 \times 100 \times 10^{-9}) = 1590 \Omega$$

$$Z_s = 0.6 \text{ m}\Omega \times (1 + 0.400/1) \times (1 + \sqrt{(1000/1000)}) = 1.68 \text{ m}\Omega$$

$$Y_o = 0.5 \text{ nS} \times (1 + 0.100/1) \times (1 + \sqrt{(100/1000)}) = 0.72 \text{ nS}$$

$$C \text{ accuracy: } A_e = [0.05 + 1.68 \text{ m}/1590 \times 100 + 0.72 \text{ n} \times 1590 \times 100] \times 1 = 0.05\%$$

$$D \text{ accuracy: } D_e = 0.05/100 = 0.0005$$

### Basic accuracy

Basic accuracy  $A_b$  is given below.

**Table 12. Measurement time mode = SHORT**

Test frequency [Hz]	Test signal voltage				
	5 mVrms - 50 mVrms	50 mVrms - 0.3 Vrms	0.3 Vrms - 1 Vrms	1 Vrms - 10 Vrms	10 Vrms - 20 Vrms
20 - 125	(0.6%) × (50 mVrms/Vs)	0.60%	0.30%	0.30%	0.30%
125 - 1 M	(0.2%) × (50 mVrms/Vs)	0.20%	0.10%	0.15%	0.15%
1 M - 2 M	(0.4%) × (50 mVrms/Vs)	0.40%	0.20%	0.30%	0.30%

**Table 13. Measurement time mode = MED, LONG**

Test frequency [Hz]	Test signal voltage				
	5 mVrms - 50 mVrms	50 mVrms - 0.3 Vrms	0.3 Vrms - 1 Vrms	1 Vrms - 10 Vrms	10 Vrms - 20 Vrms
20 - 100	(0.25%) × (30 mVrms/Vs)	0.25%	0.10%	0.15%	0.15%
100 - 1 M	(0.1%) × (30 mVrms/Vs)	0.10%	0.05%	0.10%	0.15%
1 M - 2 M	(0.2%) × (30 mVrms/Vs)	0.20%	0.10%	0.20%	0.30%

Vs [Vrms] Test signal voltage

### Effect by impedance of DUT

**Table 14. For impedance of DUT below 30  $\Omega$ , the following value is added.**

Test frequency [Hz]	Impedance of DUT	
	$1.08 \Omega \leq  Z_x  < 30 \Omega$	$ Z_x  < 1.08 \Omega$
20 - 1 M	0.05%	0.10%
1 M - 2 M	0.10%	0.20%

**Table 15. For impedance of DUT over 9.2 k  $\Omega$ , the following value is added.**

Test frequency [Hz]	Impedance of DUT	
	$9.2 \text{ k}\Omega <  Z_x  \leq 92 \text{ k}\Omega$	$92 \text{ k}\Omega <  Z_x $
10 k - 100 k	0%	0.05%
100 k - 1 M	0.05%	0.05%
1 M - 2 M	0.10%	0.10%

### Effect of cable extension

When the cable is extended, the following element is added per one meter.

$$0.015 \% \times (F_m/1 \text{ MHz})^2 \times (L_{\text{cable}})^2$$

F<sub>m</sub> [Hz]      Test Frequency

L<sub>cable</sub> [m]    Cable length

## Short offset Zs

**Table 16. Impedance of DUT > 1.08 Ω**

Test frequency [Hz]	Measurement time mode	
	SHORT	MED, LONG
20 - 2 M	$2.5 \text{ m}\Omega \times (1 + 0.400/V_s) \times (1 + \sqrt{(1000/F_m)})$	$0.6 \text{ m}\Omega \times (1 + 0.400/V_s) \times (1 + \sqrt{(1000/F_m)})$

**Table 17. Impedance of DUT ≤ 1.08 Ω**

Test frequency [Hz]	Measurement time mode	
	SHORT	MED, LONG
20 - 2 M	$1 \text{ m}\Omega \times (1 + 1/V_s) \times (1 + \sqrt{(1000/F_m)})$	$0.2 \text{ m}\Omega \times (1 + 1/V_s) \times (1 + \sqrt{(1000/F_m)})$

Vs [Vrms] Test signal voltage

Fm [Hz] Test frequency

## Effect of cable extension (Short offset)

**Table 18. When the cable is extended, the following value is added to Zs (independent of the measurement time mode).**

Test frequency [Hz]	Cable length			
	0 m	1 m	2 m	4 m
20 - 1 M	0	0.25 mΩ	0.5 mΩ	1 mΩ
1 M - 2 M	0	1 mΩ	2 mΩ	4 mΩ

## Open offset Yo

**Table 19. Test signal voltage ≤ 2.0 Vrms**

Test frequency [Hz]	Measurement time mode	
	SHORT	MED, LONG
20 - 100 k	$2 \text{ nS} \times (1 + 0.100/V_s) \times (1 + \sqrt{(100/F_m)})$	$0.5 \text{ nS} \times (1 + 0.100/V_s) \times (1 + \sqrt{(100/F_m)})$
100 k - 1 M	$20 \text{ nS} \times (1 + 0.100/V_s)$	$5 \text{ nS} \times (1 + 0.100/V_s)$
1 M - 2 M	$40 \text{ nS} \times (1 + 0.100/V_s)$	$10 \text{ nS} \times (1 + 0.100/V_s)$

**Table 20. Test signal voltage > 2.0 Vrms**

Test frequency [Hz]	Measurement time mode	
	SHORT	MED, LONG
20 - 100 k	$2 \text{ nS} \times (1 + 2/V_s) \times (1 + \sqrt{(100/F_m)})$	$0.5 \text{ nS} \times (1 + 2/V_s) \times (1 + \sqrt{(100/F_m)})$
100 k - 1 M	$20 \text{ nS} \times (1 + 2/V_s)$	$5 \text{ nS} \times (1 + 2/V_s)$
1 M - 2 M	$40 \text{ nS} \times (1 + 2/V_s)$	$10 \text{ nS} \times (1 + 2/V_s)$

### Note

The Open Offset may become three times greater in the ranges of 40 to 70 kHz and 80 to 100 kHz due to residual response.

Vs [Vrms] Test signal voltage

Fm [Hz] Test frequency

## Effect of cable length

**Table 21. When the cable is extended, multiply  $Y_0$  by the following factor.**

Test frequency [Hz]	Cable length			
	0 m	1 m	2 m	4 m
100 - 100 k	1	$1 + 5 \times F_m/1 \text{ MHz}$	$1 + 10 \times F_m/1 \text{ MHz}$	$1 + 20 \times F_m/1 \text{ MHz}$
100 k - 1 M	1	$1 + 0.5 \times F_m/1 \text{ MHz}$	$1 + 1 \times F_m/1 \text{ MHz}$	$1 + 2 \times F_m/1 \text{ MHz}$
1 M - 2 M	1	$1 + 1 \times F_m/1 \text{ MHz}$	$1 + 2 \times F_m/1 \text{ MHz}$	$1 + 4 \times F_m/1 \text{ MHz}$

$F_m$  [Hz]      Test frequency

## Temperature factor $K_t$

**Table 22. The temperature factor  $K_t$  is given below.**

Temperature [°C]	$K_t$
0 - 18	4
18 - 28	1
28 - 55	4

## Calibration accuracy Acal

Calibration accuracy Acal is given below.

For impedance of DUT on the boundary line, apply the smaller value.

**Table 23. Impedance range = 0.1, 1, 10 Ω**

	Test frequency [Hz]					
	20 - 1 k	1 k - 10 k	10 k -100 k	100 k - 300 k	300 k - 1 M	1 M - 2 M
Z  [%]	0.03	0.05	0.05	0.05 + $5 \times 10^{-5} F_m$	0.05 + $5 \times 10^{-5} F_m$	0.1 + $1 \times 10^{-4} F_m$
θ [radian]	$1 \times 10^{-4}$	$2 \times 10^{-4}$	$3 \times 10^{-4}$	$3 \times 10^{-4} +$ $2 \times 10^{-7} F_m$	$3 \times 10^{-4} +$ $2 \times 10^{-7} F_m$	$6 \times 10^{-4} +$ $4 \times 10^{-7} F_m$

**Table 24. Impedance range = 100 Ω**

	Test frequency [Hz]					
	20 - 1 k	1 k - 10 k	10 k -100 k	100 k - 300 k	300 k - 1 M	1 M - 2 M
Z  [%]	0.03	0.05	0.05	0.05 + $5 \times 10^{-5} F_m$	0.05 + $5 \times 10^{-5} F_m$	0.1 + $1 \times 10^{-4} F_m$
θ [radian]	$1 \times 10^{-4}$	$2 \times 10^{-4}$	$3 \times 10^{-4}$	$3 \times 10^{-4}$	$3 \times 10^{-4}$	$6 \times 10^{-4}$

**Table 25. Impedance range = 300, 1 kΩ**

	Test frequency [Hz]					
	20 - 1 k	1 k - 10 k	10 k -100 k	100 k - 300 k	300 k - 1 M	1 M - 2 M
Z  [%]	0.03	0.03	0.05	0.05	0.05	0.1
θ [radian]	$1 \times 10^{-4}$	$1 \times 10^{-4}$	$3 \times 10^{-4}$	$3 \times 10^{-4}$	$3 \times 10^{-4}$	$6 \times 10^{-4}$

**Table 26. Impedance range = 3 k, 10 kΩ**

	Test frequency [Hz]					
	20 - 1 k	1 k - 10 k	10 k -100 k	100 k - 300 k	300 k - 1 M	1 M - 2 M
Z  [%]	0.03 + $1 \times 10^{-4} F_m$	0.03 + $1 \times 10^{-4} F_m$	0.03 + $1 \times 10^{-4} F_m$	0.03 + $1 \times 10^{-4} F_m$	0.03 + $1 \times 10^{-4} F_m$	0.06 + $2 \times 10^{-4} F_m$
θ [radian]	(100 + $2.5 F_m) \times 10^{-6}$	(100 + $2.5 F_m) \times 10^{-6}$	(100 + $2.5 F_m) \times 10^{-6}$	(100 + $2.5 F_m) \times 10^{-6}$	(100 + $2.5 F_m) \times 10^{-6}$	(200 + $5 F_m) \times 10^{-6}$

**Table 27. Impedance range = 30 k, 100 kΩ**

	Test frequency [Hz]					
	20 - 1 k	1 k - 10 k	10 k -100 k	100 k - 300 k	300 k - 1 M	1 M - 2 M
Z  [%]	0.03 + $1 \times 10^{-3} F_m$	0.03 + $1 \times 10^{-3} F_m$	0.03 + $1 \times 10^{-3} F_m$	0.03 + $1 \times 10^{-3} F_m$	0.03 + $1 \times 10^{-4} F_m$	0.06 + $2 \times 10^{-4} F_m$
θ [radian]	(100 + $20 F_m) \times 10^{-6}$	(100 + $20 F_m) \times 10^{-6}$	(100 + $20 F_m) \times 10^{-6}$	(100 + $20 F_m) \times 10^{-6}$	(100 + $2.5 F_m) \times 10^{-6}$	(200 + $5 F_m) \times 10^{-6}$

Fm[kHz] Test frequency

## Measurement accuracy

The impedance measurement calculation example below is the result of absolute measurement accuracy.

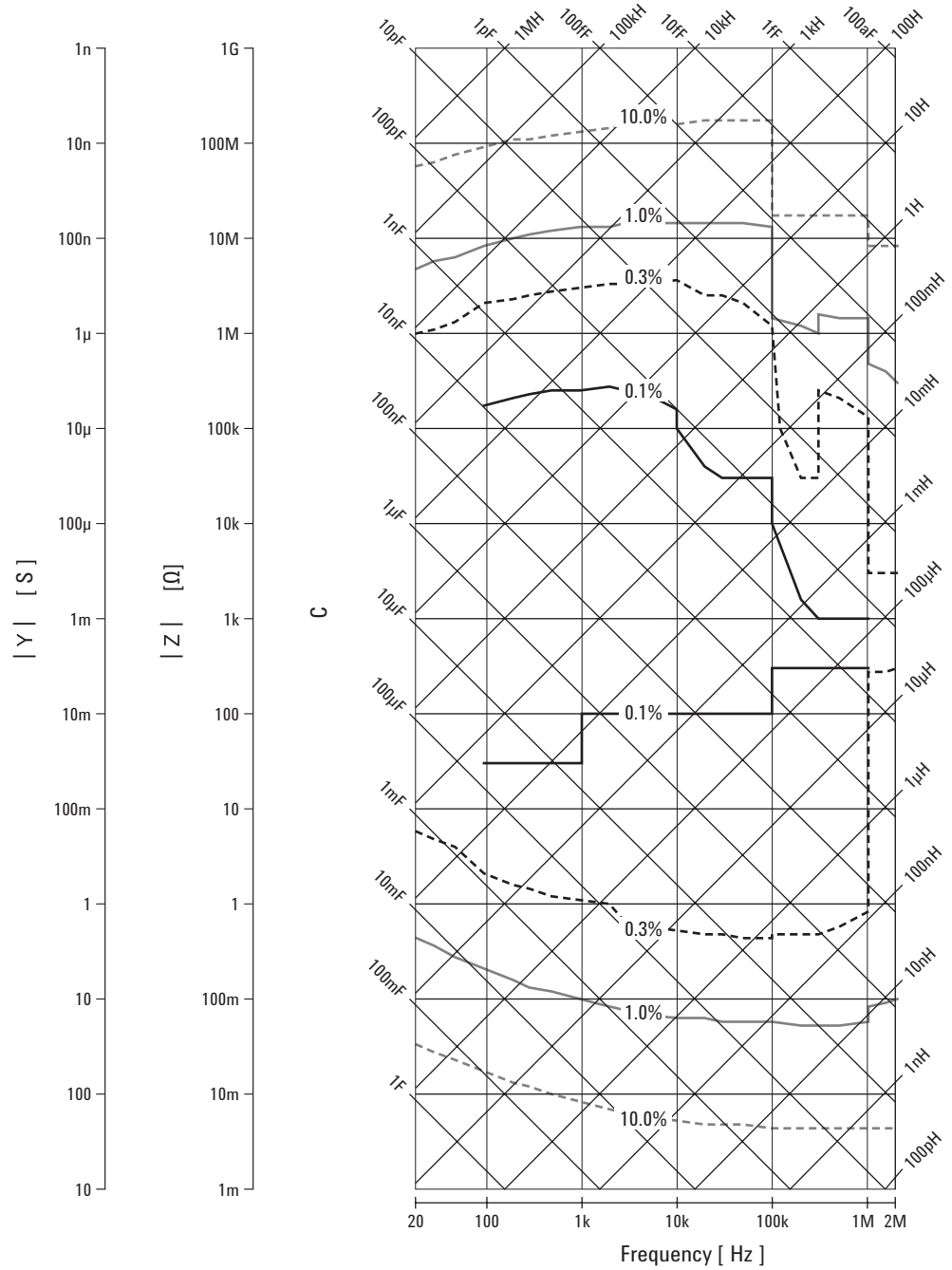

Figure 1. Impedance measurement accuracy (Test signal voltage = 1 Vrms, cable length=0 m, measurement time mode = MED)



## Compensation function

**Table 28. The E4980A provides three types of compensation functions: OPEN compensation, SHORT compensation, and LOAD compensation.**

Type of compensation	Description
OPEN compensation	Compensates errors caused by the stray admittance (C, G) of the test fixture.
SHORT compensation	Compensates errors caused by the residual impedance (L, R) of the test fixture.
LOAD compensation	Compensates errors between the actual measured value and a known standard value under the measurement conditions desired by the user.

### List sweep

**Points:** There is a maximum of 201 points.

**First sweep parameter (primary parameter):** Test frequency, test signal voltage, test signal current, test signal voltage of DC bias signal, test signal current of DC bias signal, DC source voltage.

**Second sweep parameter (secondary parameter):** None, impedance range, test frequency, test signal voltage, test signal current, test signal voltage of DC bias signal, test signal current of DC bias signal, DC source voltage

### Trigger mode

**Sequential mode:** When the E4980A is triggered once, the device is measured at all sweep points. /EOM/INDEX is output only once.

**Step mode:** The sweep point is incremented each time the E4980A is triggered. /EOM/INDEX is output at each point, but the result of the comparator function of the list sweep is available only after the last /EOM is output.

---

#### Note

A parameter selected for one of the two parameters cannot be selected for the other parameter. It is not possible to set up a combination of test signal voltage and test signal current or one of test signal voltage of DC bias signal and test signal current of DC bias.

The secondary parameter can be set only with SCPI commands.

**Comparator function of list sweep:** The comparator function enables setting one pair of lower and upper limits for each measurement point.

You can select from: Judge with the first sweep parameter/Judge with the second parameter/Not used for each pair of limits.

**Time stamp function:** In the sequential mode, it is possible to record the measurement starting time at each measurement point by defining the time when FW detects a trigger as 0 and obtain it later with the SCPI command.

### Comparator function

**Bin sort:** The primary parameter can be sorted into 9 BINS, OUT\_OF\_BINS, AUX\_BIN, and LOW\_C\_REJECT. The secondary parameter can be sorted into HIGH, IN, and LOW. The sequential mode and tolerance mode can be selected as the sorting mode.

**Limit setup:** Absolute value, deviation value, and % deviation value can be used for setup.

**BIN count:** Countable from 0 to 999999.

## DC bias signal

**Table 29. Test signal voltage**

<b>Range</b>	0 V to +2 V
<b>Resolution</b>	0 V / 1.5 V / 2 V only
<b>Accuracy</b>	0.1% + 2 mV (23 °C ± 5 °C) (0.1% + 2 mV) × 4 (0 to 18 °C or 28 to 55 °C)

**Output impedance:** 100 Ω (nominal)

## Measurement assistance functions

**Data buffer function:** Up to 201 measurement results can be read out in a batch.

**Save/Recall function:**

- Up to 10 setup conditions can be written to/read from the built-in non-volatile memory.
- Up to 10 setup conditions can be written to/read from the USB memory.
- Auto recall function can be performed when the setting conditions are written to Register 10 of the USB memory.

**Key lock function:** The front panel keys can be locked.

**GPIB:** 24-pin D-Sub (Type D-24), female; complies with IEEE488.1, 2 and SCPI.

**USB host port:** Universal serial bus jack, type-A (4 contact positions, contact 1 is on your left), female (for connection to USB memory only).

**USB interface port:** Universal serial bus jack, type mini-B (4 contact positions); complies with USBTMC-USB488 and USB 2.0; female; for connection to the external controller.

**USBTMC:** Abbreviation for USB Test & Measurement Class

**LAN:** 10/100 BaseT Ethernet, 8 pins (two speed options)

**LXI Compliance:** Class C (only applies to units with firmware revision A.02.00 or later)

### Note

The following USB memory can be used. Complies with USB 1.1; mass storage class, FAT16/FAT32 format; maximum consumption current is below 500 mA.

Recommended USB memory: 512 MB USB Flash memory (Agilent PN 1819-0195).

Use the recommended USB memory device exclusively for the E4980A, otherwise, previously saved data may be cleared. If you use a USB memory other than the recommended device, data may not be saved or recalled normally.

Agilent Technologies will NOT be responsible for data loss in the USB memory caused by using the E4980A.

# Options

## Note

Option xxx is described as E4980A-xxx in the order information

The following options are available for the E4980A LCR Meter.

## Option 001 (Power and DC bias enhancement)

Increases test signal voltage and adds the variable DC bias voltage function.

### Measurement parameters

The following parameters can be used.

- Lp-Rdc
- Ls-Rdc
- Vdc-Idc

where

Rdc Direct-current resistance (DCR)

Vdc Direct-current voltage

Idc Direct-current electricity

## Test signal

### Signal level

**Table 30. Test signal voltage**

<b>Range</b>		0 Vrms to 20 Vrms (test frequency $\leq$ 1 MHz) 0 Vrms to 15 Vrms (test frequency $>$ 1 MHz)
<b>Resolution</b>		100 $\mu$ Vrms (0 Vrms - 0.2 Vrms) 200 $\mu$ Vrms (0.2 Vrms - 0.5 Vrms) 500 $\mu$ Vrms (0.5 Vrms - 1 Vrms) 1 mVrms (1 Vrms - 2 Vrms) 2 mVrms (2 Vrms - 5 Vrms) 5 mVrms (5 Vrms - 10 Vrms) 10 mVrms (10 Vrms - 20 Vrms)
<b>Setup accuracy</b>	normal	$\pm(10\% + 1 \text{ mVrms})$ (test signal voltage $\leq$ 2 Vrms) (test frequency $\leq$ 1 MHz : spec., test frequency $>$ 1 MHz : typ.) $\pm(10\% + 10 \text{ mVrms})$ (Test frequency $\leq$ 300 kHz, test signal voltage $>$ 2 Vrms) (spec.) $\pm(15\% + 20 \text{ mVrms})$ (test frequency $>$ 300 kHz, test signal voltage $>$ 2 Vrms) (test frequency $\leq$ 1 MHz : spec., test frequency $>$ 1 MHz : typ.)
	Constant <sup>1</sup>	$\pm(6\% + 1 \text{ mVrms})$ (test signal voltage $\leq$ 2 Vrms) (test frequency $\leq$ 1 MHz : spec. , test frequency $>$ 1 MHz : typ.) $\pm(6\% + 10 \text{ mVrms})$ (test frequency $\leq$ 300 kHz, test signal voltage $>$ 2 Vrms) (spec.) $\pm(12\% + 20 \text{ mVrms})$ (test frequency $>$ 300 kHz, test signal voltage $>$ 2 Vrms) (test frequency $\leq$ 1 MHz : spec., test frequency $>$ 1 MHz : typ.)

1. When auto level control function is on.

**Table 31. Test signal current**

<b>Range</b>		0 Arms - 100 mArms
<b>Resolution</b>		1 $\mu$ Arms (0 Arms - 2 mArms) 2 $\mu$ Arms (2 mArms - 5 mArms) 5 $\mu$ Arms (5 mArms - 10 mArms) 10 $\mu$ Arms (10 mArms - 20 mArms) 20 $\mu$ Arms (20 mArms - 50 mArms) 50 $\mu$ Arms (50 mArms - 100 mArms)
<b>Setup accuracy</b>	normal	$\pm(10\% + 10 \mu\text{Arms})$ (test signal voltage $\leq 20$ mArms) (test frequency $\leq 1$ MHz : spec., test frequency $> 1$ MHz : typ.) $\pm(10\% + 100 \mu\text{Arms})$ (test frequency $\leq 300$ kHz, test signal current $> 20$ mArms) (spec.) $\pm(15\% + 200 \mu\text{Arms})$ (test frequency $> 300$ kHz, test signal voltage $> 20$ mArms) (test frequency $\leq 1$ MHz : spec., test frequency $> 1$ MHz : typ.)
	Constant <sup>1</sup>	$\pm(6\% + 10 \mu\text{Arms})$ (test signal voltage $\leq 20$ mArms) (test frequency $\leq 1$ MHz : spec., test frequency $> 1$ MHz : typ.) $\pm(6\% + 100 \mu\text{Arms})$ (test frequency $\leq 300$ kHz, test signal voltage $> 20$ mArms) (spec.) $\pm(12\% + 200 \mu\text{Arms})$ (test frequency $> 300$ kHz, test signal voltage $> 20$ mArms) (test frequency $\leq 1$ MHz : spec., test frequency $> 1$ MHz : typ.)

## Test signal level monitor function

- Test signal voltage and test signal current can be monitored.
- Level monitor accuracy:

**Table 32. Test signal voltage monitor accuracy (Vac)**

Test signal voltage <sup>2</sup>	Test frequency	Specification
5 mVrms to 2 Vrms	$\leq 1$ MHz	$\pm(3\%$ of reading value + 0.5 mVrms)
	$> 1$ MHz	$\pm(6\%$ of reading value + 1 mVrms)
$> 2$ Vrms	$\leq 300$ kHz	$\pm(3\%$ of reading value + 5 mVrms)
	$> 300$ kHz	$\pm(6\%$ of reading value + 10 mVrms) <sup>3</sup>

**Table 33. Test signal current monitor accuracy (Iac)**

Test signal current <sup>2</sup>	Test frequency	Specification
50 $\mu$ Arms to 20 mArms	$\leq 1$ MHz	$\pm(3\%$ of reading value + 5 $\mu$ Arms)
	$> 1$ MHz	$\pm(6\%$ of reading value + 10 $\mu$ Arms)
$> 20$ mArms	$\leq 300$ kHz	$\pm(3\%$ of reading value + 50 $\mu$ Arms)
	$> 300$ kHz	$\pm(6\%$ of reading value + 100 $\mu$ Arms)

1. When auto level control function is on.

2. This is not an output value but a displayed test signal level

3. Typ. when test frequency is  $> 1$  MHz with test signal voltage  $> 10$  Vrms.

## DC bias signal

**Table 34. Test signal voltage**

<b>Range</b>		-40 V to +40 V
<b>Resolution</b>		Setup resolution: 100 $\mu$ V, effective resolution: 330 $\mu$ V $\pm$ (0 V - 5 V) 1 mV $\pm$ (5 V - 10 V) 2 mV $\pm$ (10 V - 20 V) 5 mV $\pm$ (20 V - 40 V)
<b>Accuracy</b>	test signal voltage $\leq$ 2 Vrms	0.1% + 2 mV (23 $^{\circ}$ C $\pm$ 5 $^{\circ}$ C) (0.1% + 2 mV) $\times$ 4 (0 to 18 $^{\circ}$ C or 28 to 55 $^{\circ}$ C)
	test signal voltage $>$ 2 Vrms	0.1 % + 4 mV (23 $^{\circ}$ C $\pm$ 5 $^{\circ}$ C) (0.1% + 4 mV) $\times$ 4 (0 to 18 $^{\circ}$ C or 28 to 55 $^{\circ}$ C)

**Table 35. Test signal current**

<b>Range</b>		-100 mA - 100 mA
<b>Resolution</b>		Setup resolution: 1 $\mu$ A, effective resolution: 3.3 $\mu$ A $\pm$ (0 A - 50 mA) 10 $\mu$ A $\pm$ (50 mA - 100 mA)

### DC bias voltage level monitor Vdc

(0.5% of reading value + 60 mV)  $\times$  Kt

When using Vdc-Idc measurement: (spec.)

When using level monitor: (typ.)

Kt Temperature coefficient

### DC bias current level monitor Idc

(A [%] of the measurement value + B [A])  $\times$  Kt

When using Vdc-Idc measurement: (spec.)

When using level monitor: (typ.)

A [%] When the measurement time mode is SHORT: 2%  
When the measurement time mode is MED or LONG: 1%

B [A] given below

Kt Temperature coefficient

When the measurement mode is SHORT, double the following value.

**Table 36. Test signal voltage  $\leq 0.2$  Vrms (measurement time mode = MED, LONG)**

DC bias current range	Impedance range [ $\Omega$ ]				
	< 100	100	300, 1 k	3 k, 10 k	30k, 100 k
20 $\mu$ A	150 $\mu$ A	30 $\mu$ A	3 $\mu$ A	300 nA	45 nA
200 $\mu$ A	150 $\mu$ A	30 $\mu$ A	3 $\mu$ A	300 nA	300 nA
2 mA	150 $\mu$ A	30 $\mu$ A	3 $\mu$ A	3 $\mu$ A	3 $\mu$ A
20 mA	150 $\mu$ A	30 $\mu$ A	30 $\mu$ A	30 $\mu$ A	30 $\mu$ A
100 mA	150 $\mu$ A	150 $\mu$ A	150 $\mu$ A	150 $\mu$ A	150 $\mu$ A

**Table 37. 0.2 Vrms < test signal voltage  $\leq 2$  Vrms (measurement time mode = MED, LONG)**

DC bias current range	Impedance range [ $\Omega$ ]				
	< 100	100, 300	1k, 3 k	10k, 30 k	100 k
20 $\mu$ A	150 $\mu$ A	30 $\mu$ A	3 $\mu$ A	300 nA	45 nA
200 $\mu$ A	150 $\mu$ A	30 $\mu$ A	3 $\mu$ A	300 nA	300 nA
2 mA	150 $\mu$ A	30 $\mu$ A	3 $\mu$ A	3 $\mu$ A	3 $\mu$ A
20 mA	150 $\mu$ A	30 $\mu$ A	30 $\mu$ A	30 $\mu$ A	30 $\mu$ A
100 mA	150 $\mu$ A	150 $\mu$ A	150 $\mu$ A	150 $\mu$ A	150 $\mu$ A

**Table 38. Test signal voltage > 2 Vrms (measurement time mode = MED, LONG)**

DC bias current range	Impedance range [ $\Omega$ ]			
	$\leq 300$	1 k, 3 k	10k, 30 k	100 k
20 $\mu$ A	150 $\mu$ A	30 $\mu$ A	3 $\mu$ A	300 nA
200 $\mu$ A	150 $\mu$ A	30 $\mu$ A	3 $\mu$ A	300 nA
2 mA	150 $\mu$ A	30 $\mu$ A	3 $\mu$ A	3 $\mu$ A
20 mA	150 $\mu$ A	30 $\mu$ A	30 $\mu$ A	30 $\mu$ A
100 mA	150 $\mu$ A	150 $\mu$ A	150 $\mu$ A	150 $\mu$ A

**Table 39. Input impedance (nominal)**

Input impedance	Conditions
0 $\Omega$	Other than conditions below.
20 $\Omega$	Test signal voltage $\leq 0.2$ Vrms, Impedance range $\geq 3$ k $\Omega$ , DC bias current range $\leq 200$ $\mu$ A
	Test signal voltage $\leq 2$ Vrms, Impedance range $\geq 10$ k $\Omega$ , DC bias current range $\leq 200$ $\mu$ A
	Test signal voltage > 2 Vrms, Impedance range = 100 k $\Omega$ , DC bias current range $\leq 200$ $\mu$ A

**DC source signal****Table 40. Test signal voltage**

Range	-10 V to 10 V
Resolution	1 mV
Accuracy	0.1% + 3 mV (23 $^{\circ}$ C $\pm$ 5 $^{\circ}$ C) (0.1% + 3 mV) x 4 (0 to 18 $^{\circ}$ C or 28 to 55 $^{\circ}$ C)

**Table 41. Test signal current**

Range	-45 mA to 45 mA (nominal)
-------	---------------------------

**Output impedance**  
100  $\Omega$  (nominal)

## DC resistance (Rdc) accuracy

### Absolute measurement accuracy Aa

Absolute measurement accuracy Aa is given as

$$\text{Equation 15.} \quad Aa = Ae + Acal$$

Aa Absolute accuracy (% of reading value)

Ae Relative accuracy (% of reading value)

Acal Calibration accuracy

### Relative measurement accuracy Ae

Relative measurement accuracy Ae is given as

$$\text{Equation 16.} \quad Ae = [Ab + (Rs / |Rm| + Go \times |Rm|) \times 100] \times Kt$$

Rm Measurement value

Ab Basic accuracy

Rs Short offset [ $\Omega$ ]

Go Open offset [S]

Kt Temperature coefficient

### Calibration accuracy Acal

Calibration accuracy Acal is 0.03%.

### Basic accuracy Ab

**Table 42. Basic accuracy Ab is given below.**

Measurement time mode	Test signal voltage	
	$\leq 2 \text{ Vrms}$	$> 2 \text{ Vrms}$
SHORT	1.00%	2.00%
MED	0.30%	0.60%

### Open offset Go

**Table 43. Open offset Go is given below.**

Measurement time mode	Test signal voltage	
	$\leq 2 \text{ Vrms}$	$> 2 \text{ Vrms}$
SHORT	50 nS	500 nS
MED	10 nS	100 nS

### Short offset Rs

**Table 44. Short offset Rs is given below.**

Measurement time mode	Test signal voltage	
	$\leq 2 \text{ Vrms}$	$> 2 \text{ Vrms}$
SHORT	25 m $\Omega$	250 m $\Omega$
MED	5 m $\Omega$	50 m $\Omega$

### Effect of cable length (Short offset)

**Table 45. The following value is added to Rs when the cable is extended.**

Cable length		
1 m	2 m	4 m
0.25 mΩ	0.5 mΩ	1 mΩ

### Temperature coefficient Kt

**Table 46. Temperature coefficient Kt is given below.**

Temperature [°C]	Kt
0 - 18	4
18 - 28	1
28 - 55	4

### Other options

**Option 002 (Bias current interface):** Adds a digital interface to allow the E4980A LCR meter to control the Agilent 42841A bias current source.

**Option 005 (Entry model):** Economy option with less measurement speed. Same measurement accuracy as the standard model.

**Option 007 (Standard model):** Upgrade to the standard model.

**Option 201 (Handler interface):** Adds handler interface.

**Option 301 (Scanner interface):** Adds scanner interface.

---

#### Note

Option 007 can be installed only in the E4980A with option 005.



# General specifications

**Table 47. Power source**

Voltage	90 VAC - 264 VAC
Frequency	47 Hz - 63 Hz
Power consumption	Max. 150 VA

**Table 48. Operating environment**

Temperature	0 - 55 °C
Humidity (≤ 40 °C, no condensation)	15% - 85% RH
Altitude	0 m - 2000 m

**Table 49. Storage environment**

Temperature	-20 - 70 °C
Humidity (≤ 60 °C, no condensation)	0% - 90% RH
Altitude	0 m - 4572 m

**Outer dimensions:** 375 (width) x 105 (height) x 390 (depth) mm (nominal)

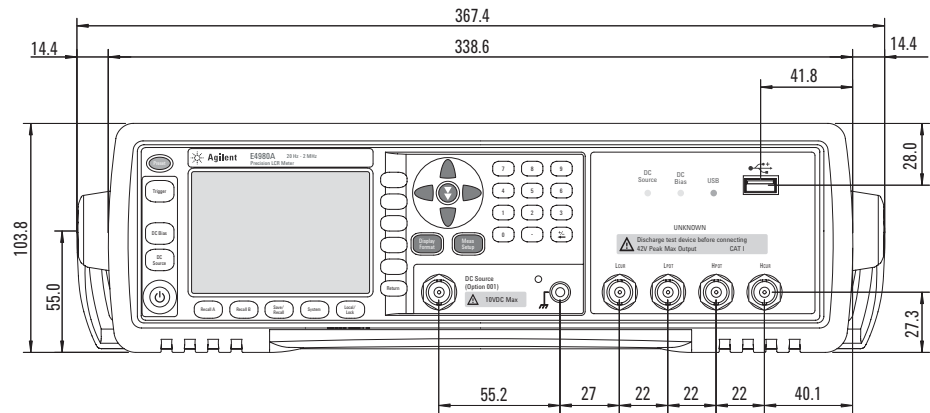

**Figure 2. Dimensions (front view, with handle and bumper, in millimeters, nominal)**

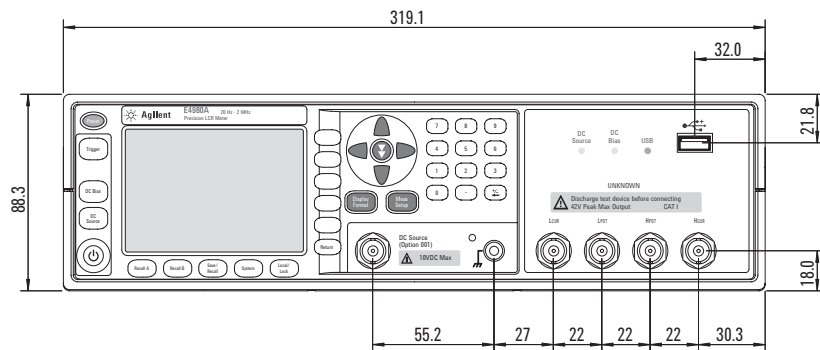

**Figure 3. Dimensions (front view, without handle and bumper, in millimeters, nominal)**

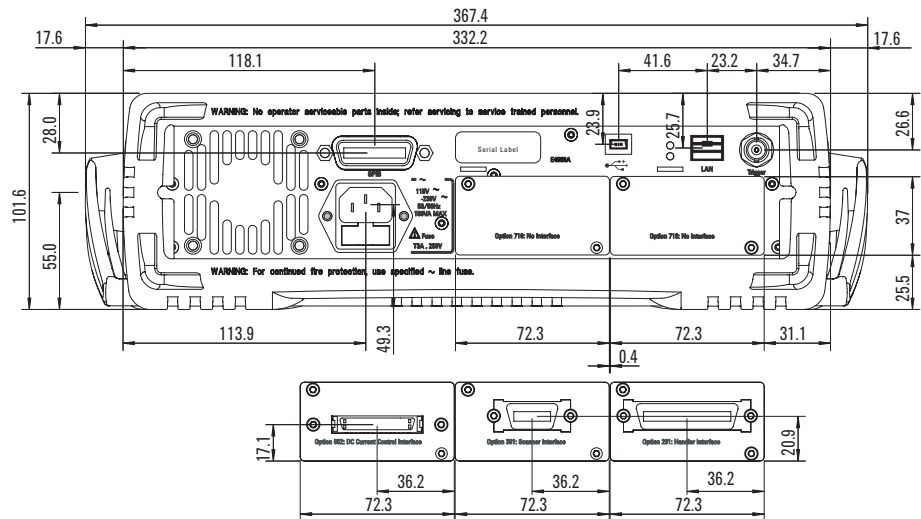

Figure 4. Dimensions (rear view, with handle and bumper, in millimeters, nominal)

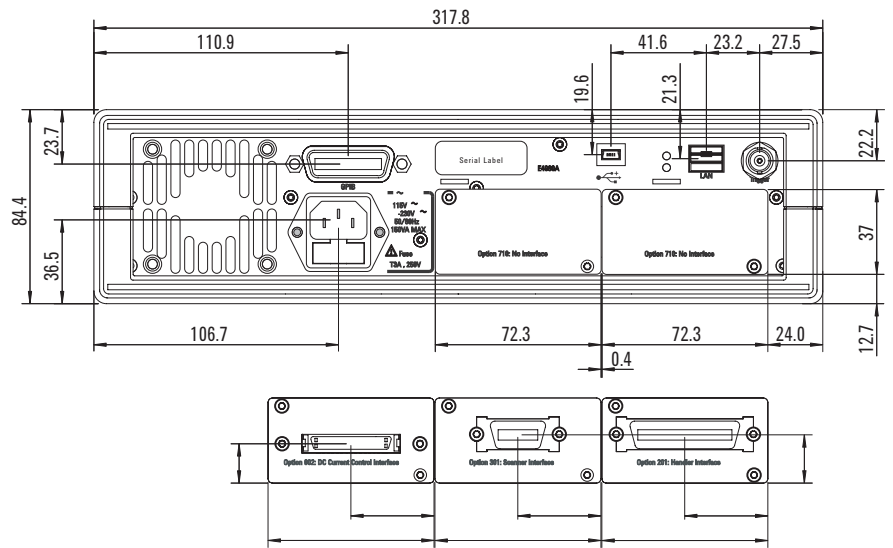
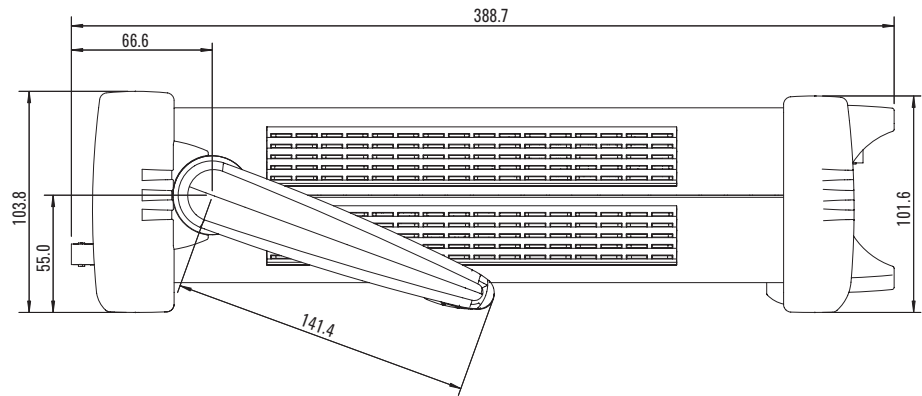
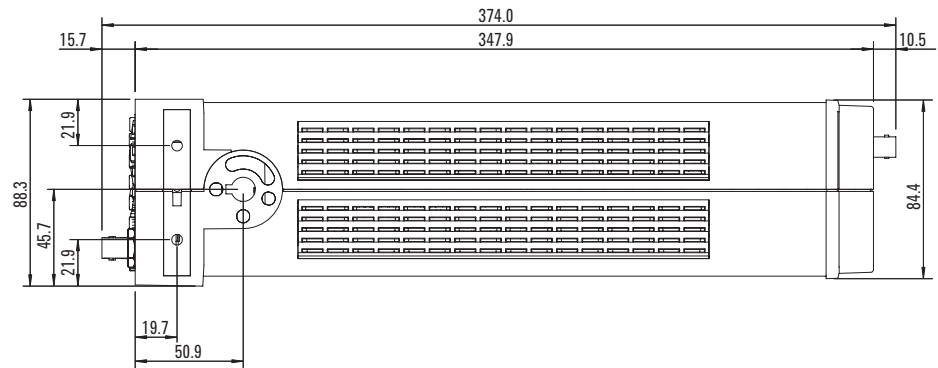

Figure 5. Dimensions (front view, without handle and bumper, in millimeters, nominal)



**Figure 6. Dimensions (side view, with handle and bumper, in millimeters, nominal)**



**Figure 7. Dimensions (side view, without handle and bumper, in millimeters, nominal)**

**Weight:** 5.3 kg (nominal)

**Display:** LCD, 320 × 240 (pixels), RGB color



**Note**

Effective pixels are more than 99.99%. There may be 0.01% (approx. 7 pixels) or smaller missing pixels or constantly lit pixels, but this is not a malfunction.



**The following items can be displayed:**

- measurement value
- measurement conditions
- limit value and judgment result of comparator
- list sweep table
- self-test message

## Description Supplemental Information

EMC	
	<p>European Council Directive 89/336/EEC, 92/31/EEC, 93/68/EEC            IEC 61326-1:1997 +A1:1998 +A2:2000            EN 61326-1:1997 +A1:1998 +A2:2001            CISPR 11:1997 +A1:1999 +A2:2002            EN 55011:1998 +A1:1999 +A2:2002 Group 1, Class A            IEC 61000-4-2:1995 +A1:1998 +A2:2001            EN 61000-4-2:1995 +A1:1998 +A2:2001 4 kV CD/8 kV AD            IEC 61000-4-3:1995 +A1:1998 +A2:2001            EN 61000-4-3:1996 +A1:1998 +A2:2001 3 V/m, 80-1000 MHz, 80% AM            IEC 61000-4-4:1995 +A1:2001 +A2:2001            EN 61000-4-4:1995 +A1:2001 +A2:2001 1 kV power /0.5 kV Signal            IEC 61000-4-5:1995 +A1:2001            EN 61000-4-5:1995 +A1:2001 0.5 kV Normal/1 kV Common            IEC 61000-4-6:1996 +A1:2001            EN 61000-4-6:1996 +A1:2001 3 V, 0.15-80 MHz, 80% AM            IEC 61000-4-11:1994 +A1:2001            EN 61000-4-11:1994 +A1:2001 100% 1 cycle</p>
<b>ICES/NMB-001</b>	<p>This ISM device complies with Canadian ICES-001:1998.            Cet appareil ISM est conforme a la norme NMB-001 du Canada.</p>
 <b>N10149</b>	<p>AS/NZS 2064.1 Group 1, Class A</p>

## Safety

	<p>European Council Directive 73/23/EEC, 93/68/EEC            IEC 61010-1:2001/EN 61010-1:2001            Measurement Category I, Pollution Degree 2, Indoor Use            IEC60825-1:1994 Class 1 LED</p>
 <b>LR95111C</b>	<p>CAN/CSA C22.2 61010-1-04            Measurement Category I, Pollution Degree 2, Indoor Use</p>

## Environment



This product complies with the WEEE Directive (2002/96/EC) marking requirements. The affixed label indicates that you must not discard this electrical/electronic product in domestic household waste.

Product Category: With reference to the equipment types in the WEEE Directive Annex I, this product is classed as a "Monitoring and Control instrumentation" product.

# Supplemental Information

## Settling time

**Table 50. Test frequency setting time**

Test frequency setting time	Test frequency (Fm)
5 ms	$F_m \geq 1 \text{ kHz}$
12 ms	$1 \text{ kHz} > F_m \geq 250 \text{ Hz}$
22 ms	$250 \text{ Hz} > F_m \geq 60 \text{ Hz}$
42 ms	$60 \text{ Hz} > F_m$

**Table 51. Test signal voltage setting time**

Test signal voltage setting time	Test frequency (Fm)
11 ms	$F_m \geq 1 \text{ kHz}$
18 ms	$1 \text{ kHz} > F_m \geq 250 \text{ Hz}$
26 ms	$250 \text{ Hz} > F_m \geq 60 \text{ Hz}$
48 ms	$60 \text{ Hz} > F_m$

Switching of the impedance range is as follows:

$\leq 5 \text{ ms/ range switching}$

## Measurement circuit protection

The maximum discharge withstand voltage, where the internal circuit remains protected if a charged capacitor is connected to the UNKNOWN terminal, is given below.

### Note

Discharge capacitors before connecting them to the UNKNOWN terminal or a test fixture to avoid damages to the instrument.

**Table 52. Maximum discharge withstand voltage**

Maximum discharge withstand voltage	Range of capacitance value C of DUT
1000 V	$C < 2 \mu\text{F}$
$\sqrt{2/C} \text{ V}$	$2 \mu\text{F} \leq C$

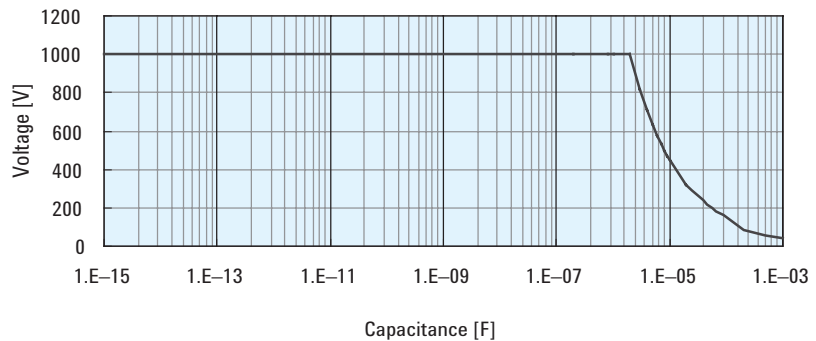

**Figure 8. Maximum discharge withstand voltage**

## Measurement time

### Definition

This is the time between the trigger and the end of measurement (EOM) output on the handler interface.

### Conditions

Table 53 shows the measurement time when the following conditions are satisfied:

- Normal impedance measurement other than Ls-Rdc, Lp-Rdc, Vdc-Idc
- Impedance range mode: hold range mode
- DC bias voltage level monitor: OFF
- DC bias current level monitor: OFF
- Trigger delay: 0 s
- Step delay: 0 s
- Calibration data: OFF
- Display mode: blank

**Table 53. Measurement time [ms](DC bias:OFF)**

	Measurement time mode	Test frequency						
		20 Hz	100 Hz	1 kHz	10 kHz	100 kHz	1 MHz	2 MHz
1	LONG	480	300	240	230	220	220	220
2	MED	380	180	110	92	89	88	88
3	SHORT	330	100	20	7.7	5.7	5.6	5.6

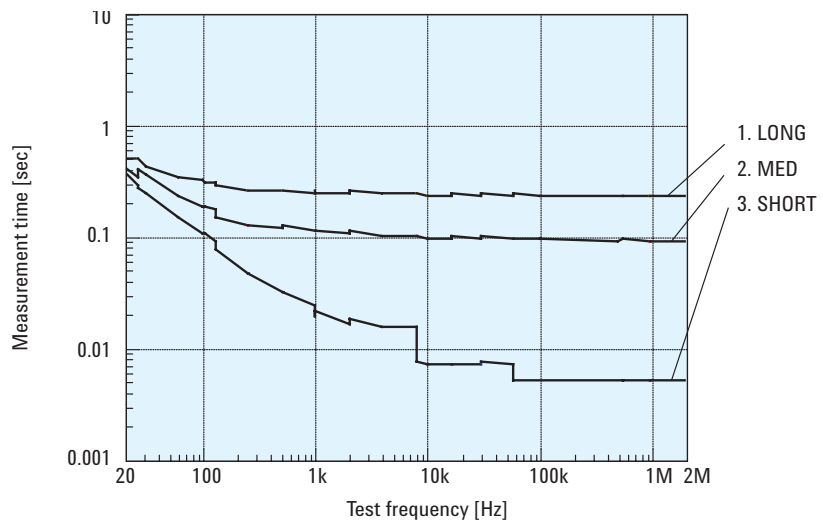

**Figure 9. Measurement time (DC bias: OFF)**

**Table 54. Measurement time when option 005 is installed [ms]  
(DC bias: OFF)**

	Measurement time mode	Test frequency						
		20 Hz	100 Hz	1 kHz	10 kHz	100 kHz	1 MHz	2 MHz
1	LONG	1190	650	590	580	570	570	570
2	MED	1150	380	200	180	180	180	180
3	SHORT	1040	240	37	25	23	23	23

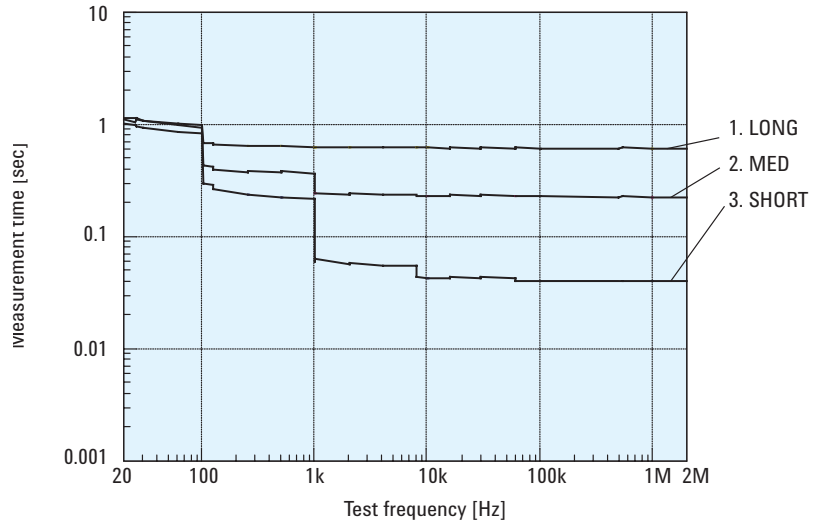

**Figure 10. Measurement time (DC bias: OFF, Option 005)**

When DC bias is ON, the following time is added:

**Table 55. Additional time when DC bias is ON [ms]**

Test frequency							
20 Hz	100 Hz	1 kHz	10 kHz	100 kHz	1 MHz	2 MHz	
30	30	10	13	2	0.5	0.5	

When the number of averaging increases, the measurement time is given as

$$\text{Equation 17.} \quad \text{MeasTime} + (\text{Ave} - 1) \times \text{AveTime}$$

MeasTime Measurement time calculated based on Table 53 and Table 54

Ave Number of averaging

AveTime Refer to Table 56

**Table 56. Additional time per averaging [ms]**

Measurement time mode	Test frequency						
	20 Hz	100 Hz	1 kHz	10 kHz	100 kHz	1 MHz	2 MHz
SHORT	51	11	2.4	2.3	2.3	2.2	2.2
MED	110	81	88	87	85	84	84
LONG	210	210	220	220	220	210	210

**Table 57. Measurement time when Vdc-Idc is selected [ms]**

Measurement time mode	Test frequency						
	20 Hz	100 Hz	1 kHz	10 kHz	100 kHz	1 MHz	2 MHz
SHORT	210	46	14	14	14	14	14
MED	210	170	170	170	170	170	170
LONG	410	410	410	410	410	410	410

Add the same measurement time per 1 additional average

Additional Measurement time when the Vdc and Idc monitor function is ON.

Add SHORT mode of Table 57. When using only Vdc or Idc, add a half of SHORT mode of Table 57.

**Table 58. Measurement time when Ls-Rdc or Lp-Rdc is selected [ms]**

Measurement time mode	Test frequency						
	20 Hz	100 Hz	1 kHz	10 kHz	100 kHz	1 MHz	2 MHz
SHORT	910	230	43	24	22	22	22
MED	1100	450	300	280	270	270	270
LONG	1400	820	700	670	660	650	650

Add the three times of measurement time per 1 additional average number

## Display time

Except for the case of the DISPLAY BLANK page, the time required to update the display on each page (display time) is as follows. When a screen is changed, drawing time and switching time are added. The measurement display is updated about every 100 ms.

**Table 59. Display time**

Item	When Vdc, Idc monitor is OFF	When Vdc, Idc monitor is ON
MEAS DISPLAY page drawing time	10 ms	13 ms
MEAS DISPLAY page (large) drawing time	10 ms	13 ms
BIN No. DISPLAY page drawing time	10 ms	13 ms
BIN COUNT DISPLAY page drawing time	10 ms	13 ms
LIST SWEEP DISPLAY page drawing time	40 ms	—
Measurement display switching time	35 ms	—



## Measurement data transfer time

This table shows the measurement data transfer time under the following conditions. The measurement data transfer time varies depending on measurement conditions and computers.

**Table 60. Measurement transfer time under the following conditions:**

<b>Host computer:</b>	DELL OPTIPLEX GX260 Pentium 4 2.6 GHz
<b>Display:</b>	ON
<b>Impedance range mode:</b>	AUTO (The overload has not been generated.)
<b>OPEN/SHORT/LOAD compensation:</b>	OFF
<b>Test signal voltage monitor:</b>	OFF

**Table 61. Measurement data transfer time [ms]**

Interface	Data transfer format	using :FETC? command (one point measurement)		using data buffer memory (list sweep measurement)			
		Comparator ON	Comparator OFF	10 points	51 points	128 points	201 points
GPIB	ASCII	2	2	4	13	28	43
	ASCII Long	2	2	5	15	34	53
	Binary	2	2	4	10	21	32
USB	ASCII	2	2	3	8	16	23
	ASCII Long	2	2	4	9	19	28
	Binary	2	2	3	5	9	13
LAN	ASCII	3	4	5	12	24	36
	ASCII Long	3	3	5	13	29	44
	Binary	3	3	5	9	18	26

**DC bias test signal current (1.5 V/2.0 V):** Output current: Max. 20 mA

**Option 001 (Power and DC Bias enhance):**

**DC bias voltage:** DC bias voltage applied to DUT is given as:

$$\text{Equation 18.} \quad V_{dut} = V_b - 100 \times I_b$$

$V_{dut}$  [V] DC bias voltage  
 $V_b$  [V] DC bias setting voltage  
 $I_b$  [A] DC bias current

**DC bias current:** DC bias current applied to DUT is given as:

$$\text{Equation 19.} \quad I_{dut} = V_b / (100 + R_{dc})$$

$I_{dut}$  [A] DC bias current  
 $V_b$  [V] DC bias setting current  
 $R_{dc}$  [ $\Omega$ ] DUT's DC resistance

## Maximum DC bias current

**Table 62. Maximum DC bias current when the normal measurement can be performed.**

Impedance range [Ω]	Bias current isolation		
	ON	OFF	
		Test signal voltage ≤ 2 Vrms	Test signal voltage > 2 Vrms
0.1	Auto range mode: 100 mA  Hold range mode: its values for the range.	20 mA	100 mA
1		20 mA	100 mA
10		20 mA	100 mA
100		20 mA	100 mA
300		2 mA	100 mA
1 k		2 mA	20 mA
3 k		200 μA	20 mA
10 k		200 μA	2 mA
30 k		20 μA	2 mA
100 k		20 μA	200 μA

## When DC bias is applied to DUT

When DC bias is applied to the DUT, add the following value to the absolute accuracy Ab.

**Table 63. Only when Fm < 10 kHz and |Vdc| > 5 V**

SHORT		MED, LONG	
$0.05\% \times (100 \text{ mV/Vs}) \times (1 + \sqrt{(100/Fm)})$		$0.01\% \times (100 \text{ mV/Vs}) \times (1 + \sqrt{(100/Fm)})$	
Fm [Hz]	Test frequency		
Vs [V]	Test signal voltage		

## Relative measurement accuracy with bias current isolation

When DC bias Isolation is set to ON, add the following value to the open offset Yo.

Equation 20.  $Yo\_DCI1 \times (1 + 1/(Vs)) \times (1 + \sqrt{(500/Fm)}) + Yo\_DCI2$

Zm [Ω]	Impedance of DUT
Fm [Hz]	Test frequency
Vs [V]	Test signal voltage
Yo_DC1,2 [S]	Calculate this by using Table 61 and 62
Idc [A]	DC bias isolation current

**Table 64. Yo\_DC11 value**

DC bias current range	Measurement time mode	
	SHORT	MED, LONG
20 μA	0 S	0 S
200 μA	0.25 nS	0.05 nS
2 mA	2.5 nS	0.5 nS
20 mA	25 nS	5 nS
100 mA	250 nS	50 nS

**Table 65. Yo\_DC12 value**

DC bias current range	Measurement time mode			
	≤ 100 Ω	300 Ω, 1 k Ω	3 k Ω, 10 k Ω	30 k Ω, 100 k Ω
20 μA	0 S	0 S	0 S	0 S
200 μA	0 S	0 S	0 S	0 S
2 mA	0 S	0 S	0 S	3 nS
20 mA	0 S	0 S	30 nS	30 nS
100 mA	0 S	300 nS	300 nS	300 nS

## DC bias settling time

When DC bias is set to ON, add the following value to the settling time:

**Table 66. DC bias settling time**

	Bias	Settling time
1	Standard	Capacitance of DUT $\times 100 \times \log_e (2/1.8 \text{ m}) + 3 \text{ m}$
2	Option 001	Capacitance of DUT $\times 100 \times \log_e (40/1.8 \text{ m}) + 3 \text{ m}$

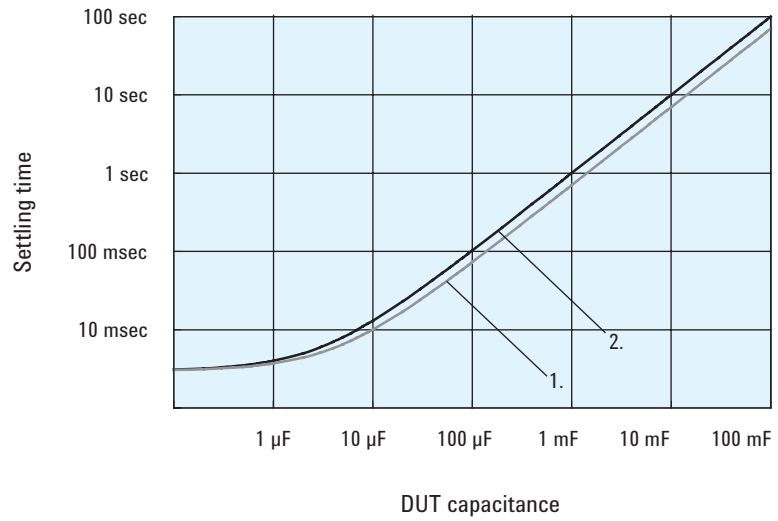

**Figure 11. DC bias settling time**

## Web Resources

Visit our Web sites for additional product information and literature.

E4980A Precision LCR Meter  
[www.agilent.com/find/e4980a](http://www.agilent.com/find/e4980a)

LCR meters  
[www.agilent.com/find/lcrmeters](http://www.agilent.com/find/lcrmeters)

Impedance analyzers  
[www.agilent.com/find/impedance](http://www.agilent.com/find/impedance)

RF & MW test accessories  
[www.agilent.com/find/mta](http://www.agilent.com/find/mta)



### Agilent Email Updates

[www.agilent.com/find/emailupdates](http://www.agilent.com/find/emailupdates)  
Get the latest information on the products and applications you select.



### Agilent Direct

[www.agilent.com/find/agilentdirect](http://www.agilent.com/find/agilentdirect)  
Quickly choose and use your test equipment solutions with confidence.



### [www.lxistandard.org](http://www.lxistandard.org)

LXI is the LAN-based successor to GPIB, providing faster, more efficient connectivity. Agilent is a founding member of the LXI consortium.

## Remove all doubt

Our repair and calibration services will get your equipment back to you, performing like new, when promised. You will get full value out of your Agilent equipment throughout its lifetime. Your equipment will be serviced by Agilent-trained technicians using the latest factory calibration procedures, automated repair diagnostics and genuine parts. You will always have the utmost confidence in your measurements. For information regarding self maintenance of this product, please contact your Agilent office.

Agilent offers a wide range of additional expert test and measurement services for your equipment, including initial start-up assistance, onsite education and training, as well as design, system integration, and project management.

For more information on repair and calibration services, go to:

[www.agilent.com/find/removealldoubt](http://www.agilent.com/find/removealldoubt)

For more information on Agilent Technologies' products, applications or services, please contact your local Agilent office. The complete list is available at:

[www.agilent.com/find/contactus](http://www.agilent.com/find/contactus)

### Americas

Canada	(877) 894-4414
Latin America	305 269 7500
United States	(800) 829-4444

### Asia Pacific

Australia	1 800 629 485
China	800 810 0189
Hong Kong	800 938 693
India	1 800 112 929
Japan	0120 (421) 345
Korea	080 769 0800
Malaysia	1 800 888 848
Singapore	1 800 375 8100
Taiwan	0800 047 866
Thailand	1 800 226 008

### Europe & Middle East

Austria	01 36027 71571
Belgium	32 (0) 2 404 93 40
Denmark	45 70 13 15 15
Finland	358 (0) 10 855 2100
France	0825 010 700*
	*0.125 €/minute
Germany	07031 464 6333
Ireland	1890 924 204
Israel	972-3-9288-504/544
Italy	39 02 92 60 8484
Netherlands	31 (0) 20 547 2111
Spain	34 (91) 631 3300
Sweden	0200-88 22 55
Switzerland	0800 80 53 53
United Kingdom	44 (0) 118 9276201

Other European Countries:  
[www.agilent.com/find/contactus](http://www.agilent.com/find/contactus)

Revised: July 2, 2009

Product specifications and descriptions in this document subject to change without notice.

© Agilent Technologies, Inc. 2009  
Printed in USA, July 31, 2009  
5989-4435EN

