

Linear/Saturating Choke



Description

- Linear/saturating choke
- Flexible wire
- Low noise development by using iron powder toroids instead of conventional iron lamination cores
- Fully potted resign

Standards

- EN 60938

Applications

- Phase angle control circuits with thyristors, triacs or transistors
- The choke acts at its optimum when it is mounted directly at the interference originator (thyristor, triac)

References

[General Product Information](#)

Weblinks

[Approvals](#), [RoHS](#), [CHINA-RoHS](#), [e-Store](#), [Distributor-Stock-Check](#)

Technical Data

Rated voltage	up to 440VAC	Isolation Voltage	2 kV eff., winding to ambient
Rated Current	5 - 45 A @ Ta 45 °C	Climatic Category	25/100/21 acc. to IEC 60068-1
Power Operating Frequency	50Hz	Allowable Operation Temp.	-25 °C to 100 °C
Terminal technic	THT, Flexible wire		
Weight	149 - 1423 g		
Material: Housing	UL 94V-0		
Sealing Compound	UL 94V-0		

Dimensions

Case 25W

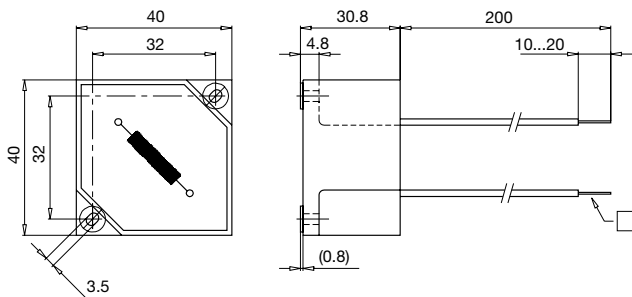

Case 47W

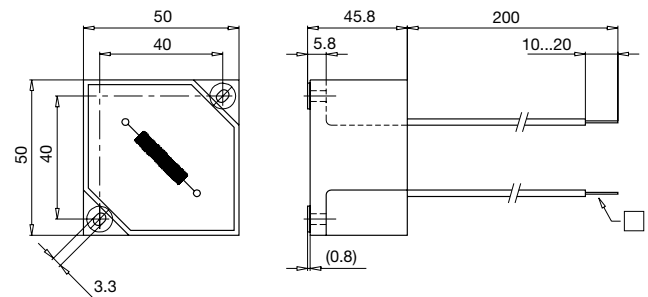

Case 32W

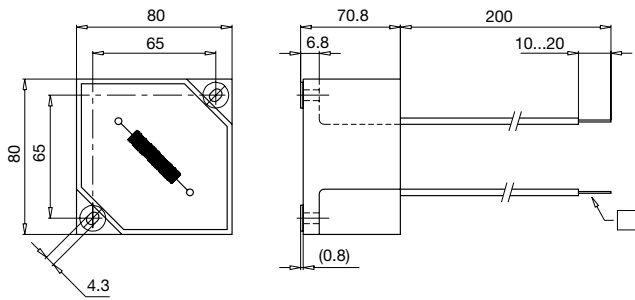

Diagrams

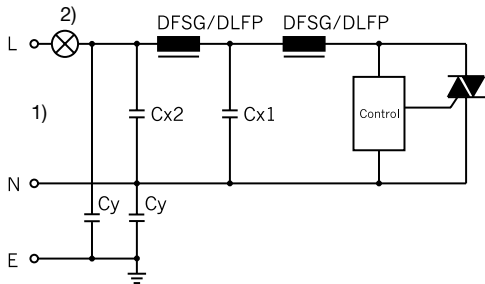

Interference suppression with resistive load, 2-phase
1) Line
2) Load

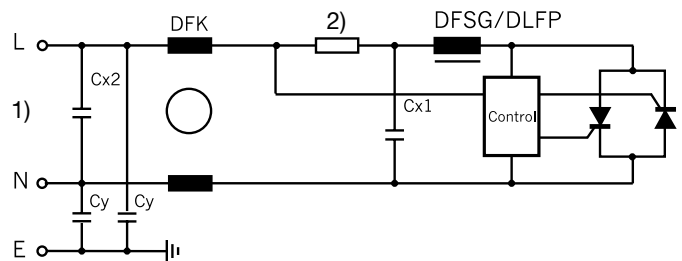

Interference suppression with resistive load, 2-stage
DFSG: Radio interference suppression saturation choke
DFK: Radio interference suppression choke magnetically condensed
1) Line
2) Load

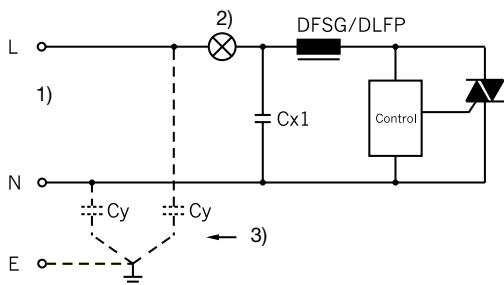

Interference suppression with resistive load, < 10A, e.g. dimmers circuit (DFSG)
1) Line
2) Load
3) only to protection class I

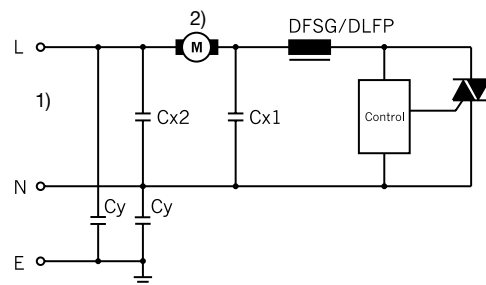

Interference suppression with inductive load
1) Line
2) Load

Derating Curves

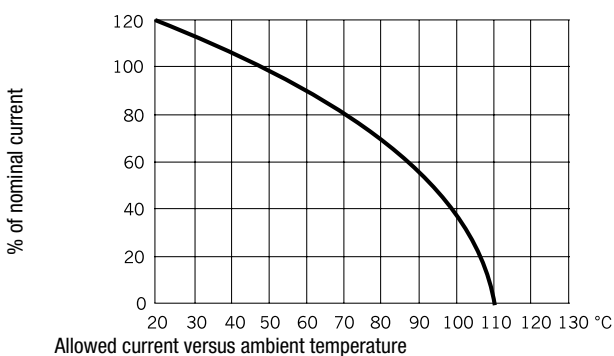

Variants

I_n [A]	L_n [mH]	Inductance drop max [%]	R_{cu} [mΩ]	Tripped Power Dissipation	f_{RES} [MHz]	Cx [μF]	Copper ø [mm]	Weight [g]	Housing	Packing unit [pcs.]	Order Number
5	1	60	120	3	0.8	0.047	1	149	25W	10	DLFP-0125-0501
8	0.5	60	54	3.5	1.32	0.1	1.25	150	25W	10	DLFP-0125-08D5
45	0.2	70	6	12	1.1	1	5	1423	32W	2	DLFP-0132-45D2
12	0.5	60	38	5.5	1.16	0.1	1.7	350	47W	2	DLFP-0147-12D5
16	0.3	60	25	6.4	1.69	0.22	1.8	320	47W	2	DLFP-0147-16D3
25	0.15	60	10	6.3	2.5	0.47	2.36	350	47W	2	DLFP-0147-25D2
35	0.05	60	5.3	6.5	3.5	1.5	1.5 x 4.5	338	47W	2	DLFP-0147-35C5

Inductance drop at I_n