

PRELIMINARY SPEC

**Features**

- 0.3 INCH DIGIT HEIGHT.
- LOW CURRENT OPERATION.
- EXCELLENT CHARACTER APPEARANCE.
- EASY MOUNTING ON P.C. BOARDS OR SOCKETS.
- TWO DIGIT PACKAGE SIMPLIFIES ALIGNMENTS & ASSEMBLY.
- I.C. COMPATIBLE.
- CATEGORIZED FOR LUMINOUS INTENSITY.
- MECHANICALLY RUGGED.
- STANDARD : GRAY FACE, WHITE SEGMENT.
- RoHS COMPLIANT.

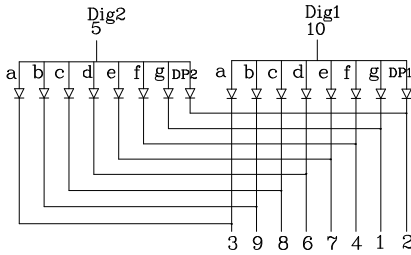
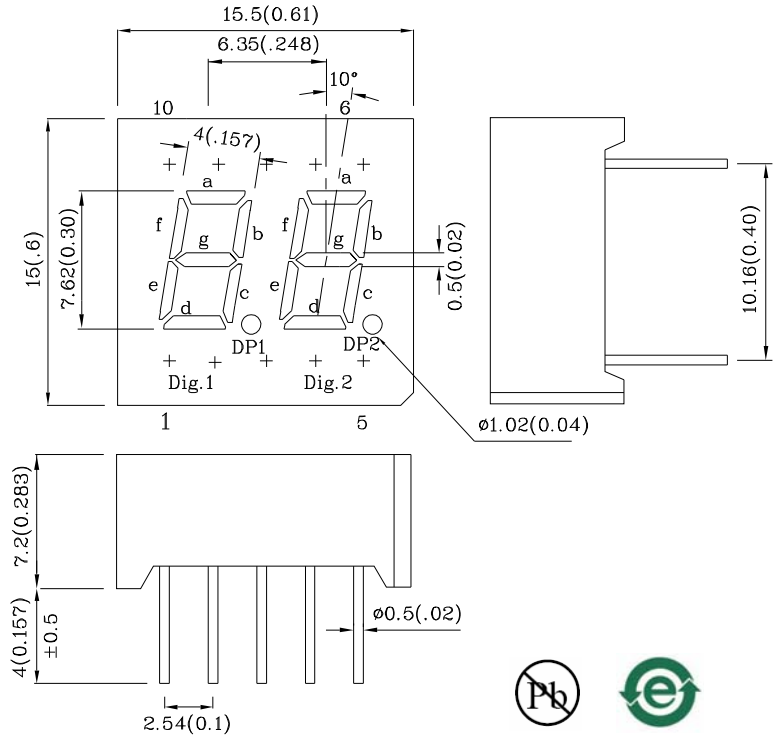

Notes:

1. All dimensions are in millimeters (inches).
2. Tolerance is  $\pm 0.25(0.01)$  unless otherwise noted.
3. Specifications are subject to change without notice.

| Absolute Maximum Ratings<br>(TA=25°C)                          |                       | UG<br>(GaP) | Unit |
|--|-----------------------|-------------|------|
| Reverse Voltage  | VR                    | 5           | V    |
| Forward Current  | IF                    | 25          | mA   |
| Forward Current (Peak)<br>1/10 Duty Cycle<br>0.1ms Pulse Width | iFS                   | 140         | mA   |
| Power Dissipation  | PT                    | 62.5        | mW   |
| Operating Temperature  | TA                    | -40 ~ +85   | °C   |
| Storage Temperature  | Tstg                  | -40 ~ +85   |      |
| Lead Solder Temperature<br>[2mm Below Package Base]            | 260°C For 3~5 Seconds |             |      |

| Operating Characteristics<br>(TA=25°C)                          |                 | UG<br>(GaP) | Unit |
|---|-----------------|-------------|------|
| Forward Voltage (Typ.)<br>(IF=10mA)                             | VF              | 2.0         | V    |
| Forward Voltage (Max.)<br>(IF=10mA)                             | VF              | 2.5         | V    |
| Reverse Current (Max.)<br>(VR=5V)                               | IR              | 10          | uA   |
| Wavelength Of Peak<br>Emission (Typ.)<br>(IF=10mA)              | $\lambda P$     | 565         | nm   |
| Wavelength Of Dominant<br>Emission (Typ.)<br>(IF=10mA)          | $\lambda D$     | 568         | nm   |
| Spectral Line Full Width<br>At Half-Maximum (Typ.)<br>(IF=10mA) | $\Delta\lambda$ | 30          | nm   |
| Capacitance (Typ.)<br>(VF=0V, f=1MHz)                           | C               | 15          | pF   |

| Part Number | Emitting Color | Emitting Material | Luminous Intensity<br>(IF=10mA)<br>mcd | Wavelength<br>nm<br>$\lambda P$ | Description                              |
|-------------|----------------|-------------------|--|---------------------------------|--|
|             |                |                   | min.                                   | typ.                            |  |
| DUG07A2-A   | Green          | GaP               | 1200                                   | 4290                            | 565<br>Common Anode, Rt. Hand<br>Decimal |

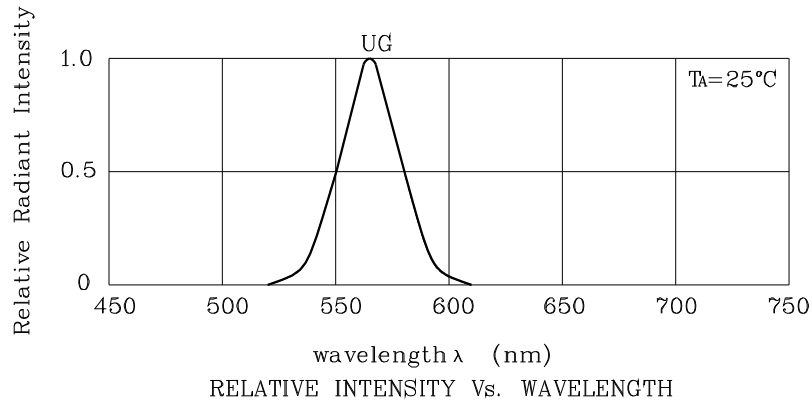

❖ UG

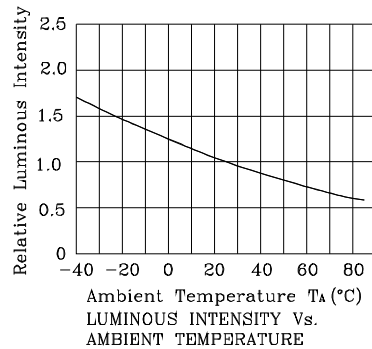
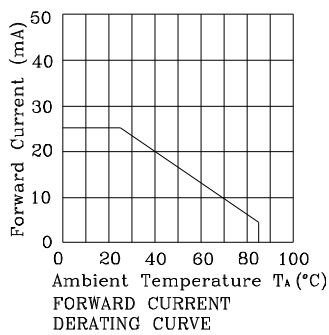
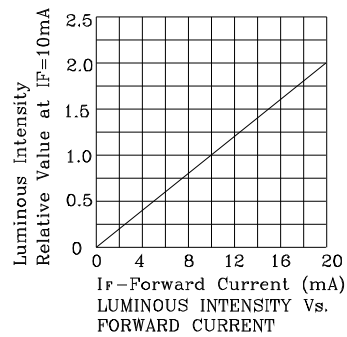
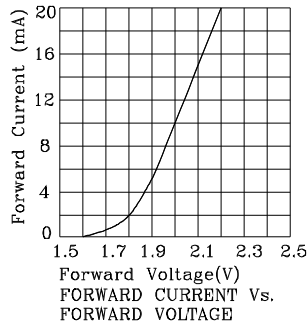

Wave Soldering Profile For Lead-free Through-hole LED.

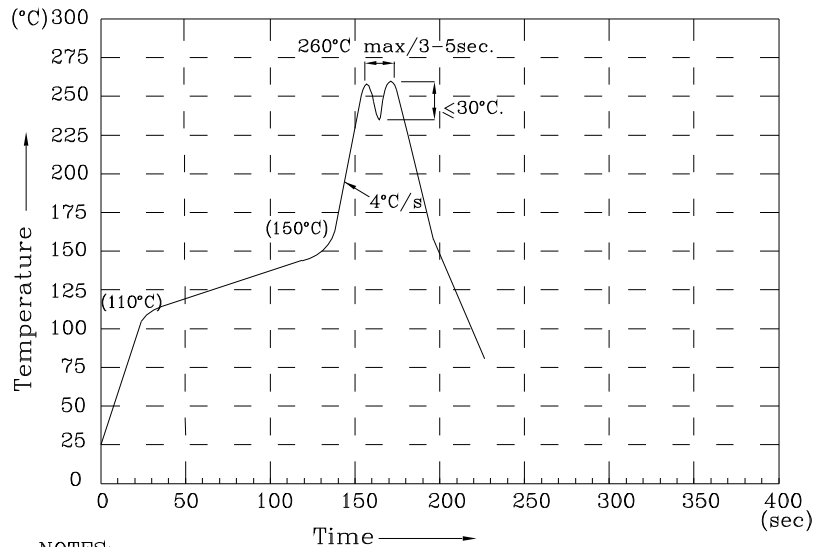

NOTES:

1. Recommend the wave temperature 245°C~260°C. The maximum soldering temperature should be less than 260°C.
2. Do not apply stress on epoxy resins when temperature is over 85 degree°C.
3. The soldering profile apply to the lead free soldering (Sn/Cu/Ag alloy).
4. No more than once.

Remarks:

If special sorting is required (e.g. binning based on forward voltage, luminous intensity / luminous flux, or wavelength),

the typical accuracy of the sorting process is as follows:

1. Wavelength: +/-1nm
2. Luminous Intensity / Luminous Flux: +/-15%
3. Forward Voltage: +/-0.1V

Note: Accuracy may depend on the sorting parameters.

**PACKING & LABEL SPECIFICATIONS**

**DUG07A2-A**

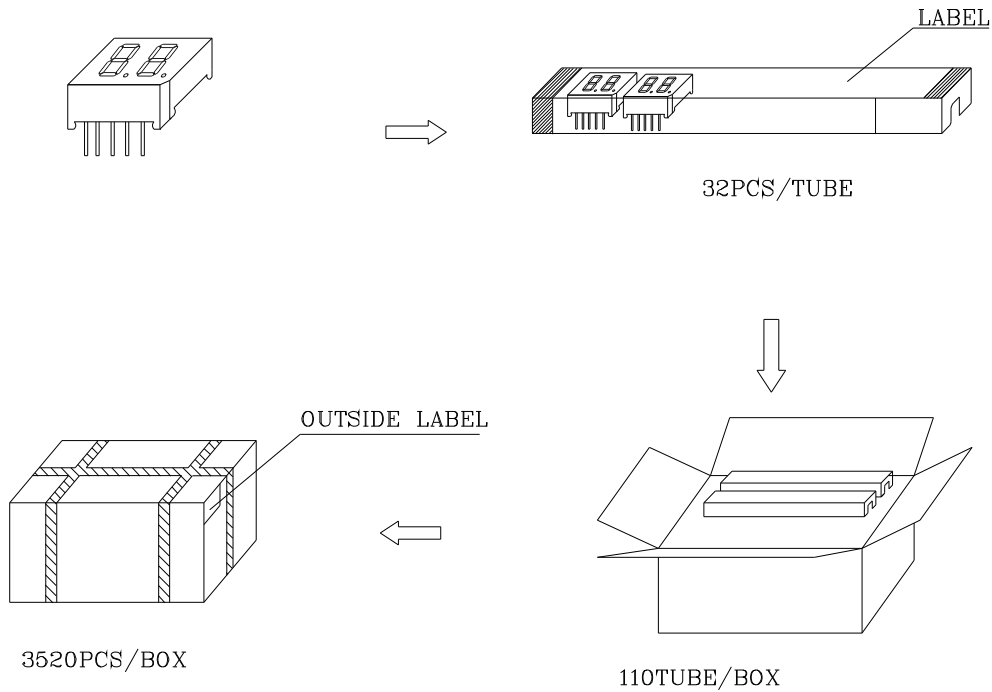

Inside LABEL Paste On The IC-tube

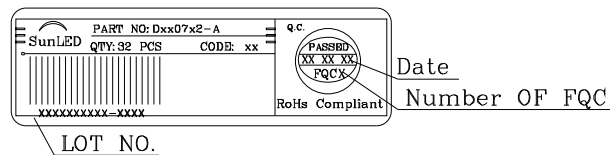

Outside LABEL Paste On The Box

