

Features

- 1.8 INCH DIGIT HEIGHT.
- LOW CURRENT OPERATION.
- EXCELLENT CHARACTER APPEARANCE.
- HIGH LIGHT OUTPUT.
- EASY MOUNTING ON P.C. BOARDS OR SOCKETS.
- I.C. COMPATIBLE.
- MULTICOLOR AVAILABLE.
- MECHANICALLY RUGGED.
- STANDARD : GRAY FACE, WHITE SEGMENT.
- RoHS COMPLIANT.

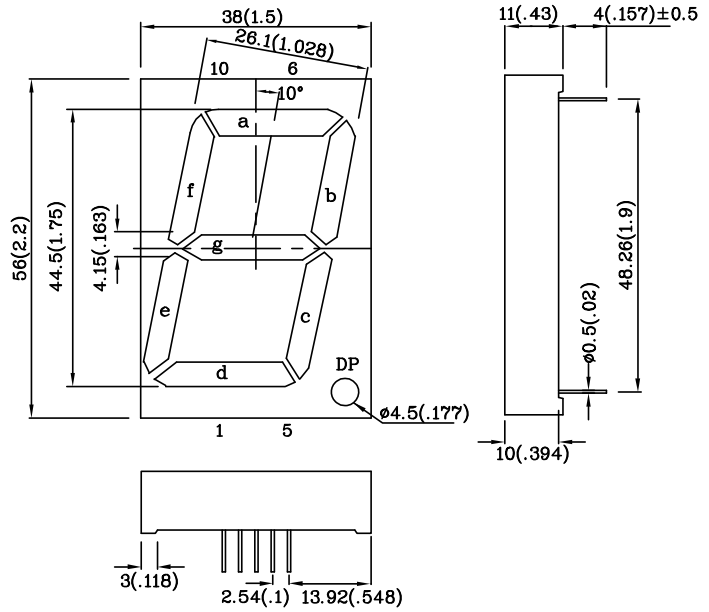
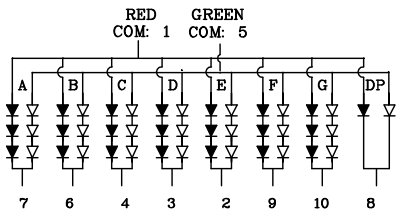

Notes:

1. All dimensions are in millimeters (inches).
2. Tolerance is $\pm 0.25(0.01)$ " unless otherwise noted.
3. Specifications are subject to change without notice.

Absolute Maximum Ratings (TA=25°C)		UR (GaAsP/ GaP)	UG (GaP)	Unit
Reverse Voltage Per Segment Or (Dp)	V _R	15 (5)	15 (5)	V
Forward Current Per Segment Or (Dp)	I _F	30 (30)	25 (25)	mA
Forward Current (Peak) 1/10 Duty Cycle 0.1ms Pulse Width Per Segment Or (Dp)	i _{FS}	160	140	mA
Power Dissipation Per Segment Or (Dp)	P _T	225 (75)	187.5 (62.5)	mW
Operating Temperature	T _A	-40 ~ +85		°C
Storage Temperature	T _{stg}	-40 ~ +85		
Lead Solder Temperature [2mm Below Package Base]	260°C For 3~5 Seconds			

Operating Characteristics (TA=25°C)		UR (GaAsP/ GaP)	UG (GaP)	Unit
Forward Voltage (Typ.) (I _F =10mA) Per Segment Or (Dp)	V _F	5.7 (1.9)	6.0 (2.0)	V
Forward Voltage (Max.) (I _F =10mA) Per Segment Or (Dp)	V _F	7.5 (2.5)	7.5 (2.5)	V
Reverse Current (Max.) (V _R =15V(5V)) Per Segment Or (Dp)	I _R	10	10	uA
Wavelength Of Peak Emission (Typ.) (I _F =10mA)	λ _P	627	565	nm
Wavelength Of Dominant Emission (Typ.) (I _F =10mA)	λ _D	625	568	nm
Spectral Line Full Width At Half-Maximum (Typ.) (I _F =10mA)	Δλ	45	30	nm
Capacitance (Typ.) (V _F =0V, f=1MHz)	C	15	15	pF

Part Number	Emitting Color	Emitting Material	Luminous Intensity (I _F =10mA) ucd		Wavelength nm λ _P	Description
			min.	typ.		
DURG46A	Red	GaAsP/GaP	4700	23990	627	Common Anode, Rt. Hand Decimal
	Green	GaP	3000	11990	565	

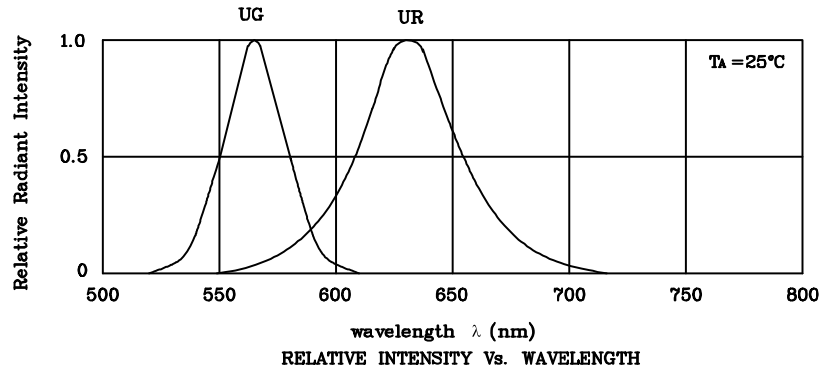

❖ UR

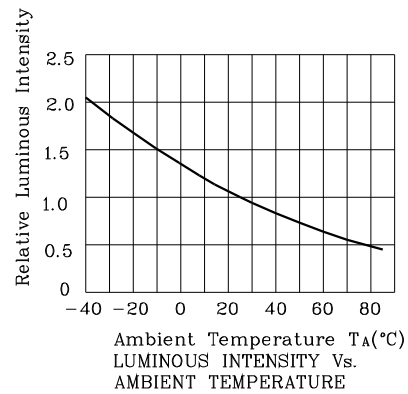
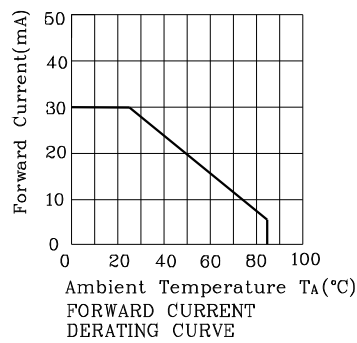
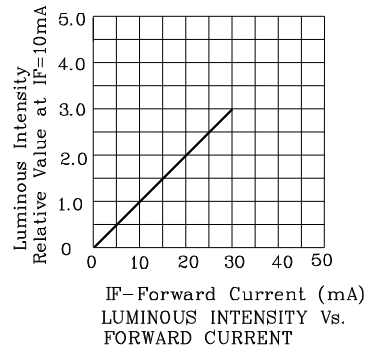
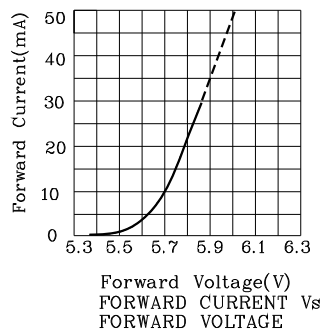

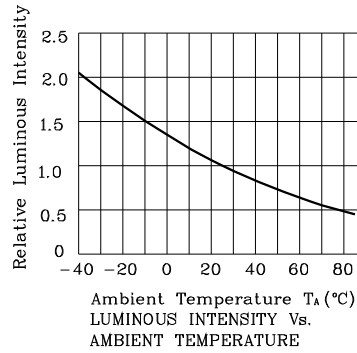
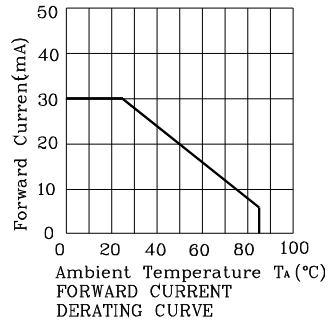
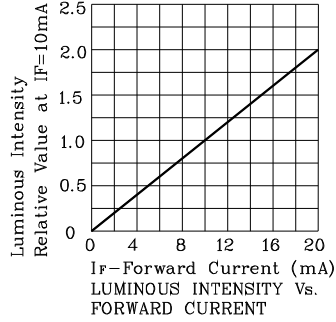
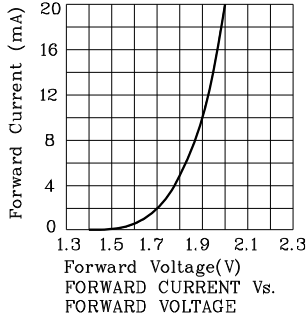

❖ UG

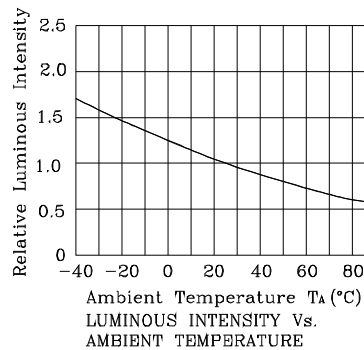
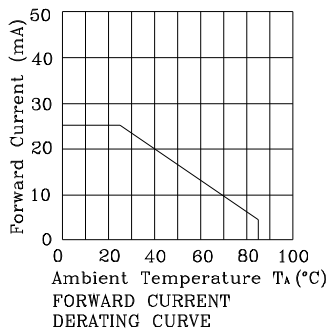
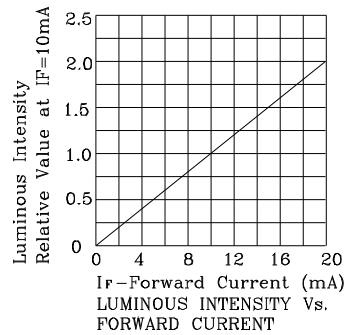
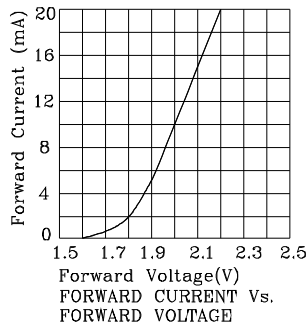
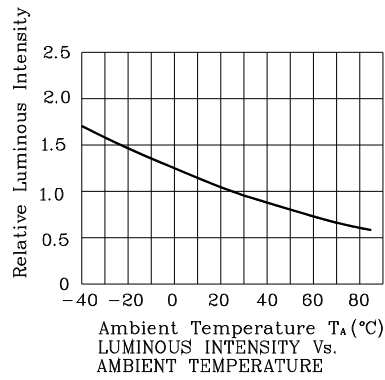
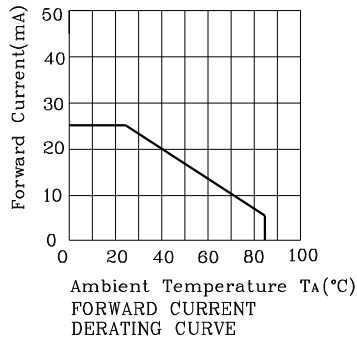
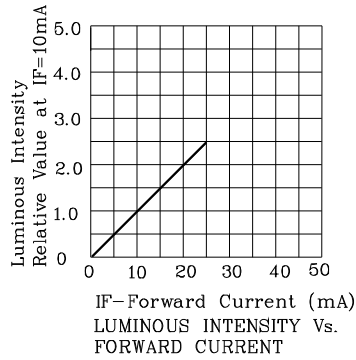
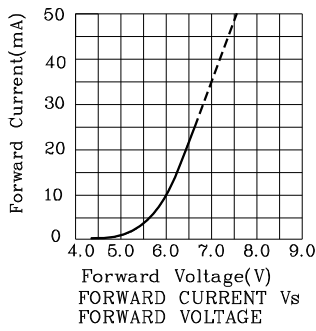

Wave Soldering Profile For Lead-free Through-hole LED.

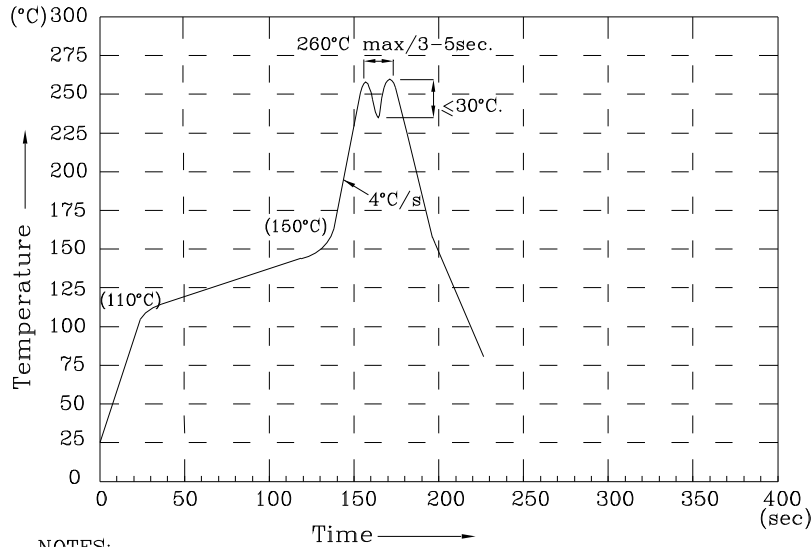

NOTES:

1. Recommend the wave temperature 245°C~260°C. The maximum soldering temperature should be less than 260°C.
2. Do not apply stress on epoxy resins when temperature is over 85 degree°C.
3. The soldering profile apply to the lead free soldering (Sn/Cu/Ag alloy).
4. No more than once.

Remarks:

If special sorting is required (e.g. binning based on forward voltage, Luminous intensity / luminous flux, or wavelength), the typical accuracy of the sorting process is as follows:

1. Wavelength: +/-1nm
2. Luminous intensity / luminous flux: +/-15%
3. Forward Voltage: +/-0.1V

Note: Accuracy may depend on the sorting parameters.

PACKING & LABEL SPECIFICATIONS

DURG46A

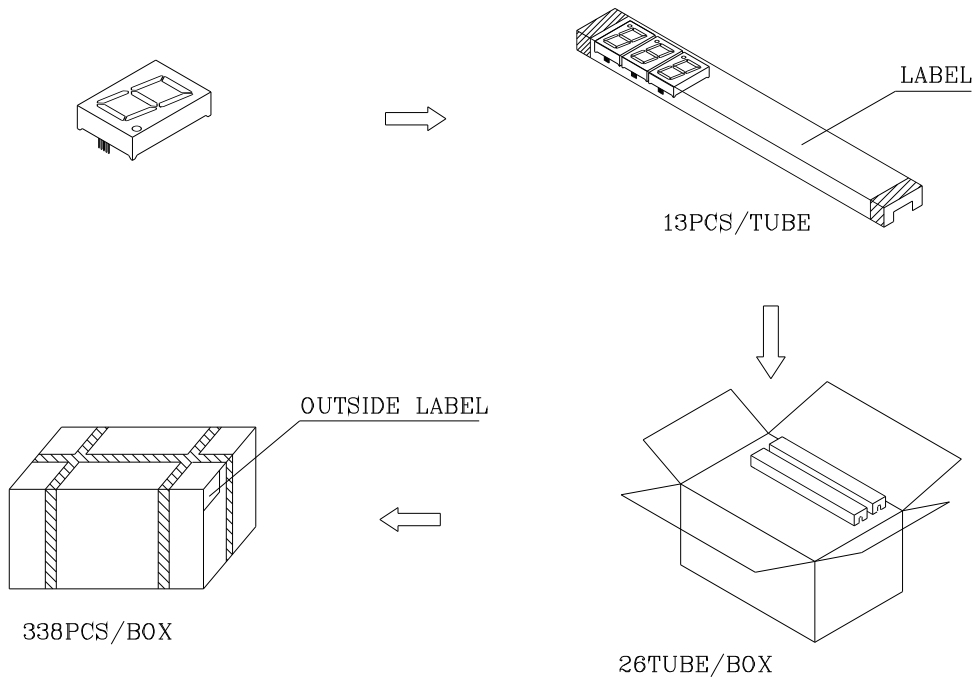

Inside LABEL Paste On The IC-tube

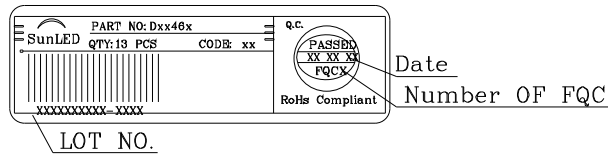

Outside LABEL Paste On The Box

