

PLEASE CHECK WWW.MOLEX.COM FOR LATEST PART INFORMATION

Part Number: [0751941001](#)
Status: **Active**
Overview: vhdm_hsd
Description: 2.00mm (.079") Pitch VHDM® Lite-Series, Board-to-Board Backplane Header, Vertical, 6-Row, Open Signal Module, 60 Circuits, Pin Length 4.75mm (.187")

Documents:

[Drawing \(PDF\)](#) [RoHS Certificate of Compliance \(PDF\)](#)
[Product Specification PS-74031-999 \(PDF\)](#)

General

Product Family	Backplane Connectors
Series	75194
Application	Backplane
Application Tooling Documents	Tooling Manual
Comments	Open Header
Component Type	PCB Header
Overview	vhdm_hsd
Product Name	VHDM Lite®
Style	N/A

Physical

Circuits (Loaded)	60
Circuits (maximum)	60
Color - Resin	Black
Durability (mating cycles max)	200
First Mate / Last Break	No
Guide to Mating Part	No
Keying to Mating Part	None
Material - Metal	High Performance Alloy (HPA)
Material - Plating Mating	Gold
Material - Plating Termination	Tin-Lead
Material - Resin	High Temperature Thermoplastic
Number of Columns	10
Number of Pairs	Open Pin Field
Number of Rows	6
Orientation	Vertical
PCB Retention	Yes
PCB Thickness Recommended (in)	0.070 In
PCB Thickness Recommended (mm)	1.80 mm
Packaging Type	Tube
Pitch - Mating Interface (in)	0.079 In
Pitch - Mating Interface (mm)	2.00 mm
Plating min: Mating (µin)	30
Plating min: Mating (µm)	0.75
Plating min: Termination (µin)	30
Plating min: Termination (µm)	0.75
Polarized to PCB	Yes
Stackable	Yes
Surface Mount Compatible (SMC)	Yes
Temperature Range - Operating	-55°C to +105°C
Termination Interface: Style	Through Hole - Compliant Pin

Electrical

Current - Maximum per Contact	1A
-------------------------------	----

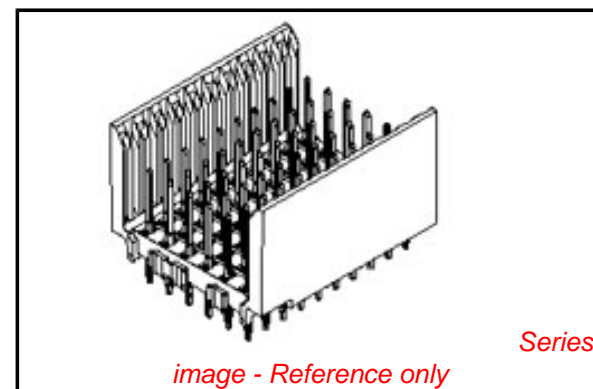

EU RoHS

RoHS Compliant by Exemption
REACH SVHC
Contains SVHC: No
Halogen-Free
Status
Not Reviewed

China RoHS



Need more information on product environmental compliance?

Email productcompliance@molex.com
 For a multiple part number RoHS Certificate of Compliance, [click here](#)

Please visit the [Contact Us](#) section for any non-product compliance questions.

Search Parts in this Series

[75194Series](#)

Mates With

[75189 VHDM® Lite Board-to-Board Daughtercard](#)

Use With

[Daughtercard Modules](#)

Application Tooling | FAQ

Tooling specifications and manuals are found by selecting the products below. Crimp Height Specifications are then contained in the Application Tooling Specification document.

Global

Description	Product #
VHDM® Signal Pin Inserter Repair Tool	0622015700
VHDM® Insertion Module for Advanced Mate Signal Header,	0622020207

Data Rate 622.0 Mbps
Real Signals (per 25mm) 72
Voltage - Maximum 120V AC (RMS)/DC

6 Row by 10 Wide,
20.00mm (.787")

Material Info

Reference - Drawing Numbers

Packaging Specification PK-74057-003
Product Specification PS-74031-999
Sales Drawing SD-75194-001

VHDM and Very High Density Metric are trademarks of Amphenol Corporation

This document was generated on 05/28/2010

PLEASE CHECK WWW.MOLEX.COM FOR LATEST PART INFORMATION

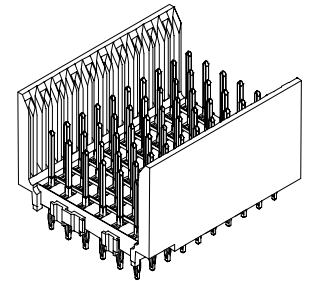
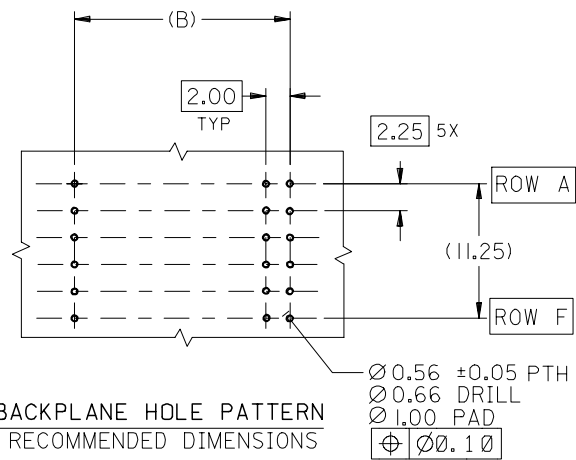
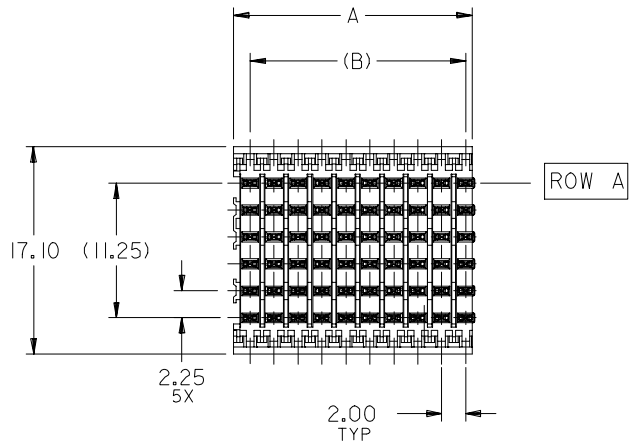

**BACKPLANE HOLE PATTERN
RECOMMENDED DIMENSIONS**

NOTES:

- MATERIALS:**
HOUSING - LIQUID CRYSTAL POLYMER (LCP),
GLASS-FILLED, UL 94V-0, COLOR: BLACK
SIGNAL PIN - COPPER ALLOY
- FINISHES:**
CONTACT AREA: SELECTIVE GOLD (Au)
PCB TAILS: SELECTIVE TIN/LEAD (Sn/Pb)
OR SELECTIVE MATTE TIN (Sn)
NICKEL (Ni) OVERALL.
- THIS PART CONFORMS TO MOLEX PRODUCT SPECIFICATION PS-74031-999
- FOR MIXED CONTACT LENGTHS CONSULT MOLEX FOR AVAILABILITY
- FOR SPECIFIC MATERIAL NUMBERS & MATING INFORMATION REFER TO SHEET 2
- PACKAGE PER PK-74057-003
- EITHER MARK PART WITH PART NUMBER & DATE CODE APPROXIMATELY WHERE SHOWN OR PLACE LABEL ON THE TUBE.

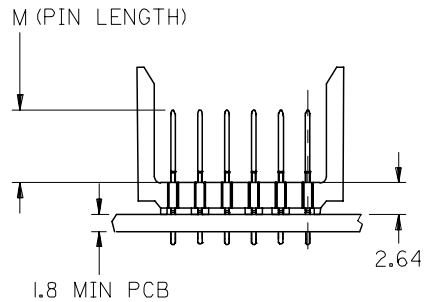
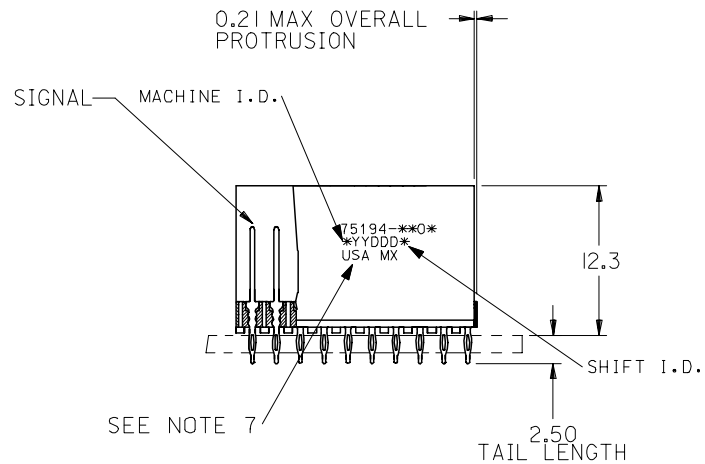

ADD LEADFREE PINS EC NO: UCP2006-0059 DRWN: KMULVEY 2005/07/13 CHKD: BINGHAM 2005/07/13 APPR: SREED 2005/07/15	QUALITY SYMBOLS ▽=0 ▽=0	GENERAL TOLERANCES (UNLESS SPECIFIED)		DIMENSION STYLE MM ONLY	SCALE 2.5:1	DESIGN UNITS METRIC	THIRD ANGLE PROJECTION																									
		<table border="1"> <tr> <th></th> <th>mm</th> <th>INCH</th> </tr> <tr> <td>4 PLACES</td> <td>± ---</td> <td>± ---</td> </tr> <tr> <td>3 PLACES</td> <td>± ---</td> <td>± ---</td> </tr> <tr> <td>2 PLACES</td> <td>± ---</td> <td>± ---</td> </tr> <tr> <td>1 PLACE</td> <td>± ---</td> <td>± ---</td> </tr> </table>		mm	INCH	4 PLACES	± ---	± ---	3 PLACES	± ---	± ---	2 PLACES	± ---	± ---	1 PLACE	± ---	± ---	<table border="1"> <tr> <th>DRAWN BY</th> <th>DATE</th> </tr> <tr> <td>MBANDURA</td> <td>2002/12/18</td> </tr> <tr> <th>CHECKED BY</th> <th>DATE</th> </tr> <tr> <td>NMARTIN</td> <td>2002/12/18</td> </tr> <tr> <th>APPROVED BY</th> <th>DATE</th> </tr> <tr> <td>CBIXLER</td> <td>2002/12/18</td> </tr> </table>	DRAWN BY	DATE	MBANDURA	2002/12/18	CHECKED BY	DATE	NMARTIN	2002/12/18	APPROVED BY	DATE	CBIXLER	2002/12/18	TITLE VHDM LITE 6 ROW OPEN END BACKPLANE SALES ASSEMBLY	
			mm	INCH																												
		4 PLACES	± ---	± ---																												
3 PLACES	± ---	± ---																														
2 PLACES	± ---	± ---																														
1 PLACE	± ---	± ---																														
DRAWN BY	DATE																															
MBANDURA	2002/12/18																															
CHECKED BY	DATE																															
NMARTIN	2002/12/18																															
APPROVED BY	DATE																															
CBIXLER	2002/12/18																															
ANGULAR ±1/2°		MATERIAL NO. SEE SHT 2	DOCUMENT NO. SD-75194-001	SHEET NO. 1 OF 2																												
DRAFT WHERE APPLICABLE MUST REMAIN WITHIN DIMENSIONS		MOLEX INCORPORATED THIS DRAWING CONTAINS INFORMATION THAT IS PROPRIETARY TO MOLEX INCORPORATED AND SHOULD NOT BE USED WITHOUT WRITTEN PERMISSION																														

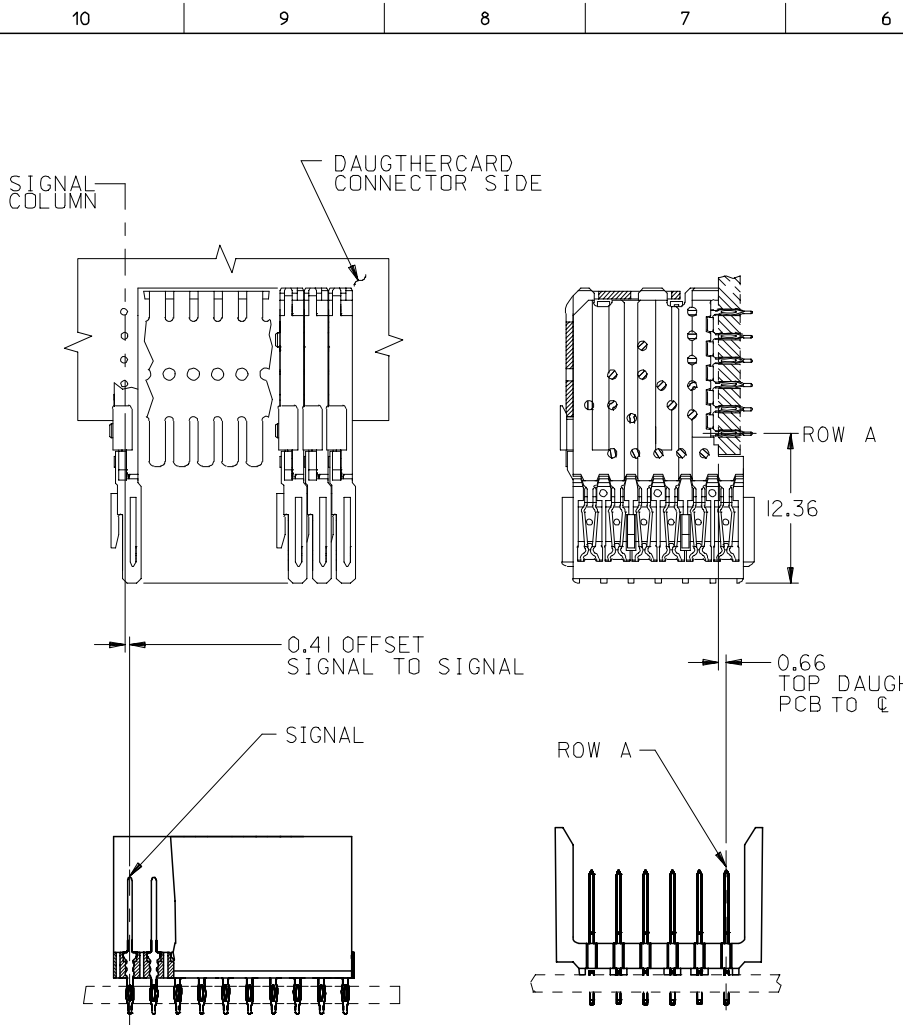

PART NUMBER	COLUMN	NUMBER OF SIGNAL PIN	NUMBER OF SHIELD	A	B	M	Au (um) THICKNESS	Sn (um) THICKNESS
75194-*001	10	60	0	20.00	18.00	4.75	0.76	0.76-1.52
75194-*501	25	150	0	50.00	48.00		0.76	
75194-*002	10	60	0	20.00	18.00	6.25	0.76	
75194-*502	25	150	0	50.00	48.00		0.76	
75194-*003	10	60	0	20.00	18.00	4.25	0.76	
75194-*503	25	150	0	50.00	48.00		0.76	
75194-*004	10	60	0	20.00	18.00	5.15	0.76	
75194-*504	25	150	0	50.00	48.00		0.76	

MATERIAL NUMBER ASSIGNMENT

75194- ** **
 SEE TABLE
 NUMBER OF COLUMNS/PLATING
 10 = 10 COLUMN TIN/LEAD
 25 = 25 COLUMN TIN/LEAD
 90 = 10 COLUMN MATTE TIN
 85 = 25 COLUMN MATTE TIN

SEE SHEET 1 EC NO: UCP2006-0059 DRWN: KMLVEY 2005/07/13 CHKD: 2005/07/13 APPR: SREED 2005/07/15	QUALITY SYMBOLS	GENERAL TOLERANCES (UNLESS SPECIFIED)	DIMENSION STYLE	SCALE	DESIGN UNITS	THIRD ANGLE PROJECTION															
	$\nabla=0$ $\nabla=0$	<table border="1"> <thead> <tr> <th></th> <th>MM</th> <th>INCH</th> </tr> </thead> <tbody> <tr> <td>4 PLACES</td> <td>± ---</td> <td>± ---</td> </tr> <tr> <td>3 PLACES</td> <td>± ---</td> <td>± ---</td> </tr> <tr> <td>2 PLACES</td> <td>± ---</td> <td>± ---</td> </tr> <tr> <td>1 PLACE</td> <td>± ---</td> <td>± ---</td> </tr> </tbody> </table>		MM	INCH	4 PLACES	± ---	± ---	3 PLACES	± ---	± ---	2 PLACES	± ---	± ---	1 PLACE	± ---	± ---	MM ONLY	2.5:1	METRIC	
		MM	INCH																		
	4 PLACES	± ---	± ---																		
3 PLACES	± ---	± ---																			
2 PLACES	± ---	± ---																			
1 PLACE	± ---	± ---																			
<table border="1"> <thead> <tr> <th>REV</th> <th>DESCRIPTION</th> </tr> </thead> <tbody> <tr> <td> </td> <td> </td> </tr> </tbody> </table>	REV	DESCRIPTION			DRAFT WHERE APPLICABLE MUST REMAIN WITHIN DIMENSIONS	DRAWN BY: MBANDURA CHECKED BY: NMARTIN APPROVED BY: CBIXLER DATE: 2002/12/18	TITLE: VHM LITE 6 ROW OPEN END BACKPLANE SALES ASSEMBLY MOLEX INCORPORATED	MATERIAL NO.: SEE CHART DOCUMENT NO.: SD-75194-001	SHEET NO.: 2 OF 2												
REV	DESCRIPTION																				