

### Wirewound Resistor with Thermal Cut-offs

Type: **ERU5T**

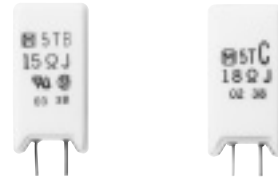

#### ■ Features

- Accurate fusing characteristics
- Low cost and easy handling
- Space saving design
- Excellent anti-surge characteristics

#### ■ Recommended Applications

- Switching regulators, video adapters, safety circuits

#### ■ Explanation of Part Numbers

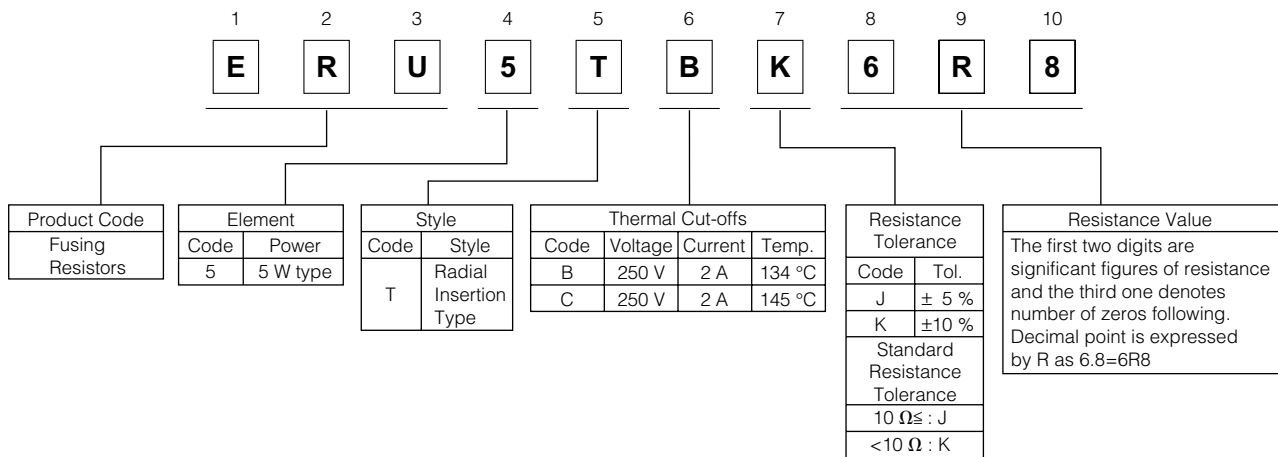

#### ■ Ratings

Code	Power Rating (W)	Current Rating (A)	Thermal Cut-off (°C)	Resistance Range (Ω)	Standard Quantity (pcs.)	Mass (Weight) [g/pc.]
B	1.6	2	134	0.18 to 680	500	6.5
C	1.8	2	145	0.18 to 680	500	6.5

#### Power Derating Curve

For resistors operated in ambient temperatures above 25 °C, power rating shall be derated in accordance with the figure on the right.

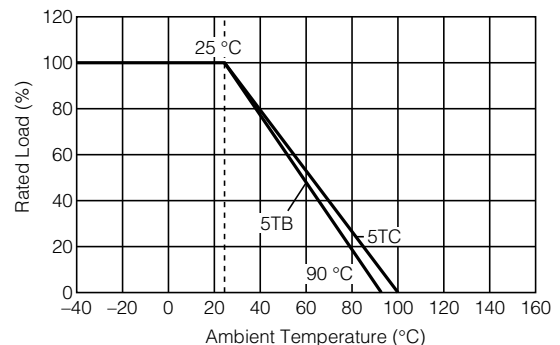

### ■ Dimensions in mm (not to scale)

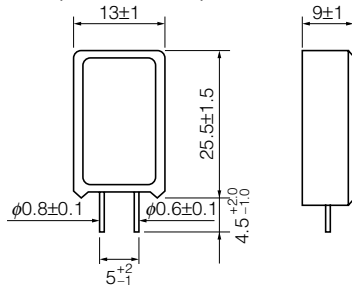

### ■ Fusing Characteristics

ERU5TBK5R1

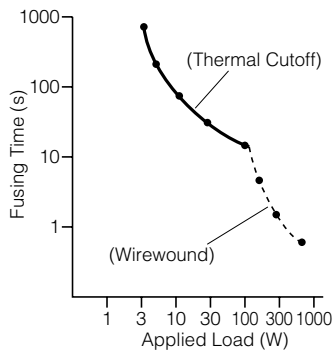

ERU5TBK6R8

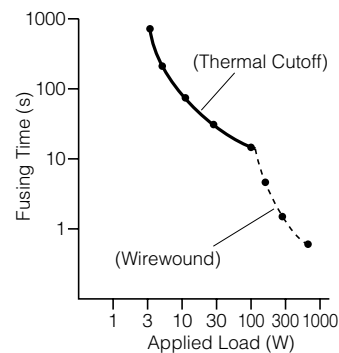

ERU5TBJ100

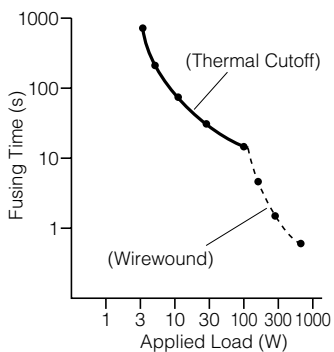

ERU5TBJ150

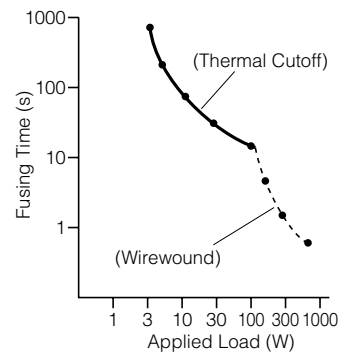

### ■ Packaging Methods

Please contact the factory for packaging methods.

### ⚠ Safety Precautions

The following are precautions for individual products. Please also refer to the precautions common to Fixed Resistors shown on page ER3 of this catalog.

1. When voltage exceeds the rated voltage and/or a current exceeds the rated current and are continuously applied, the element of Wirewound Resistor with Thermal Cutoffs (hereafter called the resistors) produces excessive heat, which may not only deteriorate the built-in the Thermal Cutoffs but also blow it.
2. The resistors have a built-in the Thermal Cutoffs. Therefore, use and store them within their respective operating and storing temperature ranges as specified in individual delivery specifications.
3. Carefully check the inductance effect of the resistors when using them in a high-frequency circuit.
4. If a transient load (heavy load in a short time) like a pulse is expected to be applied, check and evaluate the operations of the resistors when installed in your products under the most adverse conditions before use.

## ⚠ Safety Precautions (Common precautions for Fixed Resistors)

- When using our products, no matter what sort of equipment they might be used for, be sure to make a written agreement on the specifications with us in advance. The design and specifications in this catalog are subject to change without prior notice.
- Do not use the products beyond the specifications described in this catalog.
- This catalog explains the quality and performance of the products as individual components. Before use, check and evaluate their operations when installed in your products.
- Install the following systems for a failsafe design to ensure safety if these products are to be used in equipment where a defect in these products may cause the loss of human life or other significant damage, such as damage to vehicles (automobile, train, vessel), traffic lights, medical equipment, aerospace equipment, electric heating appliances, combustion/gas equipment, rotating equipment, and disaster/crime prevention equipment.
- \* Systems equipped with a protection circuit and a protection device
- \* Systems equipped with a redundant circuit or other system to prevent an unsafe status in the event of a single fault

### (1) Precautions for use

- These products are designed and manufactured for general and standard use in general electronic equipment (e.g. AV equipment, home electric appliances, office equipment, information and communication equipment)
- These products are not intended for use in the following special conditions. Before using the products, carefully check the effects on their quality and performance, and determine whether or not they can be used.
  1. In liquid, such as water, oil, chemicals, or organic solvent
  2. In direct sunlight, outdoors, or in dust
  3. In salty air or air with a high concentration of corrosive gas, such as Cl<sub>2</sub>, H<sub>2</sub>S, NH<sub>3</sub>, SO<sub>2</sub>, or NO<sub>2</sub>
  4. Electric Static Discharge (ESD) Environment
    - These components are sensitive to static electricity and can be damaged under static shock (ESD). Please take measures to avoid any of these environments.
    - Smaller components are more sensitive to ESD environment.
  5. Electromagnetic Environment
    - Avoid any environment where strong electromagnetic waves exist.
  6. In an environment where these products cause dew condensation
  7. Sealing or coating of these products or a printed circuit board on which these products are mounted, with resin or other materials
- These products generate Joule heat when energized. Carefully position these products so that their heat will not affect the other components.
- Carefully position these products so that their temperatures will not exceed the category temperature range due to the effects of neighboring heat-generating components. Do not mount or place heat-generating components or inflammables, such as vinyl-coated wires, near these products .
- Note that non-cleaning solder, halogen-based highly active flux, or water-soluble flux may deteriorate the performance or reliability of the products.
- Carefully select a flux cleaning agent for use after soldering. An unsuitable agent may deteriorate the performance or reliability. In particular, when using water or a water-soluble cleaning agent, be careful not to leave water residues. Otherwise, the insulation performance may be deteriorated.

### (2) Precautions for storage

The performance of these products, including the solderability, is guaranteed for a year from the date of arrival at your company, provided that they remain packed as they were when delivered and stored at a temperature of 5 °C to 35 °C and a relative humidity of 45 % to 85 %.

Even within the above guarantee periods, do not store these products in the following conditions. Otherwise, their electrical performance and/or solderability may be deteriorated, and the packaging materials (e.g. taping materials) may be deformed or deteriorated, resulting in mounting failures.

1. In salty air or in air with a high concentration of corrosive gas, such as Cl<sub>2</sub>, H<sub>2</sub>S, NH<sub>3</sub>, SO<sub>2</sub>, or NO<sub>2</sub>
2. In direct sunlight

### <Package markings>

Package markings include the product number, quantity, and country of origin. In principle, the country of origin should be indicated in English.