



NC7SVL04 TinyLogic® Low-I_{CC}T Inverter

Features

- 0.9V to 3.6V V_{CC} Supply Operation
- 3.6V Over-Voltage Tolerant I/Os at V_{CC} from 0.9V to 3.6V
- Power-Off High Impedance Inputs and Outputs
- Proprietary Quiet Series™ Noise / EMI Reduction Circuitry
- Ultra-Small MicroPak™ Package
- Ultra-Low Dynamic Power

Description

The NC7SVL04 is a single inverter with a low-I_{CC}T input design from Fairchild's Ultra-Low Power (ULP-A) series of TinyLogic®. The NC7SVL04 features very low quiescent current, even when the input voltage is lower than the V_{CC} supply. This feature services mobile handset applications very well, allowing for direct interface with baseband processor general-purpose I/Os. Since mobile devices rely on a battery supply, the NC7SVL04 facilitates lower power consumption in mixed-voltage rail environments.

This product is designed on an advanced CMOS technology for a wide low-voltage operating range (0.9V to 3.6V V_{CC}), high drive needs (up to 24mA), and speed (maximum propagation delay of 3.5ns, V_{CC}=3.3V). It achieves this performance while maintaining low CMOS power dissipation.

Ordering Information

Part Number	Top Mark	 Eco Status	Package	Packing Method
NC7SVL04P5X	L04	RoHS	5-Lead SC70, EIAJ SC-88a, 1.25mm Wide	3000 Units on Tape & Reel
NC7SVL04L6X	CD	RoHS	6-Lead MicroPak™, 1.00mm Wide	5000 Units on Tape & Reel
NC7SVL04FHX	CD	Green	6-Lead, MicroPak2, 1x1mm Body, .35mm Pitch	5000 Units on Tape & Reel

 For Fairchild's definition of Eco Status, please visit: http://www.fairchildsemi.com/company/green/rohs_green.html.

Connection Diagram



Figure 1. Logic Symbol

Pin Configurations

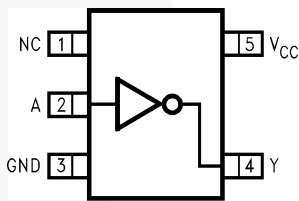

Figure 2. SC70 (Top View)

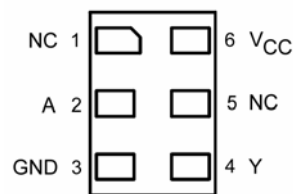

Figure 3. MicroPak™ (Top Through View)

Pin Definitions

Pin # SC70	Pin # MicroPak	Name	Description
1	1	NC	No Connect
2	2	A	Input
3	3	GND	Ground
4	4	Y	Output
5	6	V _{CC}	Supply Voltage
	5	NC	No Connect

Function Table

$Y = \overline{A}$

Inputs	Output
A	Y
L	H
H	L

H = HIGH Logic Level

L = LOW Logic Level

Absolute Maximum Ratings

Stresses exceeding the absolute maximum ratings may damage the device. The device may not function or be operable above the recommended operating conditions and stressing the parts to these levels is not recommended. In addition, extended exposure to stresses above the recommended operating conditions may affect device reliability. The absolute maximum ratings are stress ratings only.

Symbol	Parameter	Min.	Max.	Unit
V _{CC}	Supply Voltage	-0.5	4.6	V
V _{IN}	DC Input Voltage	-0.5	4.6	V
V _{OUT}	DC Output Voltage	HIGH or LOW State ⁽¹⁾	V _{CC} + 0.5	V
		V _{CC} = 0V	4.6	
I _{IK}	DC Input Diode Current		-50	mA
I _{OK}	DC Output Diode Current	V _{OUT} < 0V	-50	mA
		V _{OUT} > V _{CC}	+50	
I _{OH} / I _{OL}	DC Output Source/Sink Current		±50	mA
I _{CC} or I _{GND}	DC V _{CC} or Ground Current per Supply Pin		±50	mA
T _{STG}	Storage Temperature Range	-65	+150	°C
T _J	Junction Temperature Under Bias		+150	°C
T _L	Junction Lead Temperature, Soldering 10 Seconds		+260	°C
P _D	Power Dissipation at +85°C	SC70-5	150	mW
		MicroPak-6	130	
		MicroPak2-6	120	
ESD	Human Body Model, JEDEC:JESD22-A114		4000	V
	Charge Device Model, JEDEC:JESD22-C101		2000	

Note:

- I_O absolute maximum ratings must be observed.

Recommended Operating Conditions

The Recommended Operating Conditions table defines the conditions for actual device operation. Recommended operating conditions are specified to ensure optimal performance to the datasheet specifications. Fairchild does not recommend exceeding them or designing to Absolute Maximum Ratings.

Symbol	Parameter	Conditions	Min.	Max.	Unit
V _{CC}	Supply Voltage		0.9	3.6	V
V _{IN}	Input Voltage		0	3.6	V
V _{OUT}	Output Voltage	V _{CC} = 0V	0	3.6	V
		HIGH or LOW State	0	V _{CC}	
I _{OH} /I _{OL}	Output Current in I _{OH} /I _{OL}	V _{CC} = 3.0V to 3.6V		±24.0	mA
		V _{CC} = 2.3V to 2.7V		±18.0	
		V _{CC} = 1.65V to 1.95V		±6.0	
		V _{CC} = 1.4V to 1.6V		±4.0	
		V _{CC} = 1.1V to 1.3V		±2.0	
		V _{CC} = 0.9V		±0.1	
T _A	Operating Temperature, Free Air		-40	+85	°C
Δt/ΔV	Minimum Input Edge Rate	V _{IN} = 0.8V to 2.0V, V _{CC} = 3.0V		10	ns/V
θ _{JA}	Thermal Resistance	SC70-5		425	°C/W
		MicroPak-6		500	
		MicroPak2-6		560	

Note:

- Unused inputs must be held HIGH or LOW. They may not float.

DC Electrical Characteristics

Symbol	Parameter	V _{CC}	Conditions	T _A =25°C		T _A =-40 to +85°C		Units
				Min.	Max.	Min.	Max.	
V _{IH}	HIGH Level Input Voltage	0.90		.65 x V _{CC}		.65 x V _{CC}		V
		1.10 ≤ V _{CC} ≤ 1.30		.65 x V _{CC}		.65 x V _{CC}		
		1.40 ≤ V _{CC} ≤ 1.60		.65 x V _{CC}		.65 x V _{CC}		
		1.65 ≤ V _{CC} ≤ 1.95		0.90		.0.90		
		2.30 ≤ V _{CC} ≤ 2.70		1.50		1.50		
		2.70 ≤ V _{CC} ≤ 3.60		1.50		1.50		
V _{IL}	LOW Level Input Voltage	0.90			.25 x V _{CC}		.25 x V _{CC}	V
		1.10 ≤ V _{CC} ≤ 1.30			.25 x V _{CC}		.25 x V _{CC}	
		1.40 ≤ V _{CC} ≤ 1.60			.25 x V _{CC}		.25 x V _{CC}	
		1.65 ≤ V _{CC} ≤ 1.95			.25 x V _{CC}		.25 x V _{CC}	
		2.30 ≤ V _{CC} ≤ 2.70			0.70		0.70	
		2.70 ≤ V _{CC} ≤ 3.60			0.80		0.80	
V _{OH}	HIGH Level Output Voltage	0.90	I _{OH} =-100μA	V _{CC} -0.10		V _{CC} -0.10		V
		1.10 ≤ V _{CC} ≤ 1.30		V _{CC} -0.10		V _{CC} -0.10		
		1.40 ≤ V _{CC} ≤ 1.60		V _{CC} -0.20		V _{CC} -0.20		
		1.65 ≤ V _{CC} ≤ 1.95		V _{CC} -0.20		V _{CC} -0.20		
		2.30 ≤ V _{CC} ≤ 2.70		V _{CC} -0.20		V _{CC} -0.20		
		2.70 ≤ V _{CC} ≤ 3.60		V _{CC} -0.20		V _{CC} -0.20		
		1.10 ≤ V _{CC} ≤ 1.30	I _{OH} =-2mA	.75 x V _{CC}		.75 x V _{CC}		
		1.40 ≤ V _{CC} ≤ 1.60	I _{OH} =-4mA	.75 x V _{CC}		.75 x V _{CC}		
		1.65 ≤ V _{CC} ≤ 1.95	I _{OH} =-6mA	1.25		1.25		
		2.30 ≤ V _{CC} ≤ 2.70	I _{OH} =-6mA	2.00		2.00		
		2.30 ≤ V _{CC} ≤ 2.70	I _{OH} =-12mA	1.80		1.80		
		2.70 ≤ V _{CC} ≤ 3.60	I _{OH} =-12mA	2.20		2.20		
		2.30 ≤ V _{CC} ≤ 2.70	I _{OH} =-18mA	1.70		1.70		
		2.70 ≤ V _{CC} ≤ 3.60	I _{OH} =-18mA	2.40		2.40		
		2.70 ≤ V _{CC} ≤ 3.60	I _{OH} =-24mA	2.20		2.20		

Continued on the following page...

DC Electrical Characteristics (Continued)

Symbol	Parameter	V _{CC}	Conditions	T _A =25°C		T _A =-40 to 85°C		Units
				Min.	Max.	Min.	Max.	
V _{OL}	LOW Level Output Voltage	0.90	I _{OL} =100μA		0.10		0.10	V
		1.10 ≤ V _{CC} ≤ 1.30			0.10		0.10	
		1.40 ≤ V _{CC} ≤ 1.60			0.20		0.20	
		1.65 ≤ V _{CC} ≤ 1.95			0.20		0.20	
		2.30 ≤ V _{CC} ≤ 2.70			0.20		0.20	
		2.70 ≤ V _{CC} ≤ 3.60			0.20		0.20	
		1.10 ≤ V _{CC} ≤ 1.30	I _{OL} =2mA		0.25 x V _{CC}		0.25 x V _{CC}	
		1.40 ≤ V _{CC} ≤ 1.60	I _{OL} =4mA		0.25 x V _{CC}		0.25 x V _{CC}	
		1.65 ≤ V _{CC} ≤ 1.95	I _{OL} =6mA		0.30		0.30	
		2.30 ≤ V _{CC} ≤ 2.70	I _{OL} =12mA		0.40		0.40	
		2.70 ≤ V _{CC} ≤ 3.60			0.40		0.40	
		2.30 ≤ V _{CC} ≤ 2.70	I _{OL} =18mA		0.60		0.60	
		2.70 ≤ V _{CC} ≤ 3.60			0.40		0.40	
		2.70 ≤ V _{CC} ≤ 3.60	I _{OL} =24mA		0.55		0.55	
I _{IN}	Input Leakage Current	0.90 to 3.60	0 ≤ V _{IN} ≤ 3.60V		±0.1		±0.5	μA
I _{OFF}	Power Off Leakage Current	0	0 ≤ (V _{IN} , V _O) ≤ 3.60V		0.5		0.5	μA
I _{CC}	Quiescent Supply Current	0.90 to 3.60	V _{IN} =V _{CC} or GND		0.9		0.9	μA
			V _{CC} ≤ V _{IN} ≤ 3.60V				±0.9	
I _{CCCT}	Increase in I _{CC} per Input	1.95	V _{IN} =0.9V		6		8	μA
		3.60	V _{IN} =1.5V		6		8	

AC Electrical Characteristics

Symbol	Parameter	V _{CC}	Conditions	T _A =25°C			T _A =-40 to 85°C		Units	Figure
				Min.	Typ.	Max.	Min.	Max.		
t _{PHL} , t _{PLH}	Propagation Delay	0.90	C _L =15pF, R _L =1MΩ		34.0				ns	Figure 4 Figure 5
		1.10 ≤ V _{CC} ≤ 1.30	C _L =15pF, R _L =2kΩ	3.5	8.1	16.5	3.0	27.8		
		1.40 ≤ V _{CC} ≤ 1.60		1.5	3.7	7.0	1.5	7.5		
		1.65 ≤ V _{CC} ≤ 1.95	C _L =30pF, R _L =500Ω	1.1	2.8	5.8	1.0	6.3		
		2.30 ≤ V _{CC} ≤ 2.70		0.6	2.0	4.0	0.6	4.5		
		2.70 ≤ V _{CC} ≤ 3.60		0.5	1.5	3.5	0.5	4.0		
C _{IN}	Input Capacitance	0			3				pF	
C _{PD}	Power Dissipation Capacitance	0.90 to 3.60	V _{IN} =0V or V _{CC} , f=10MHz		5				pF	

AC Loadings and Waveforms

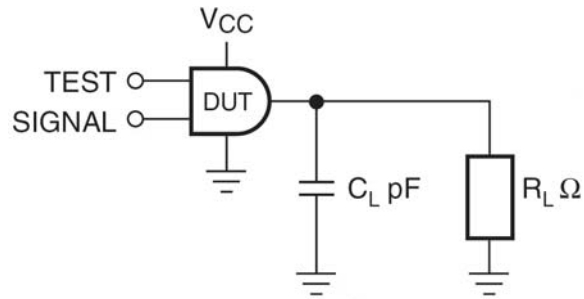

Figure 4. AC Test Circuit

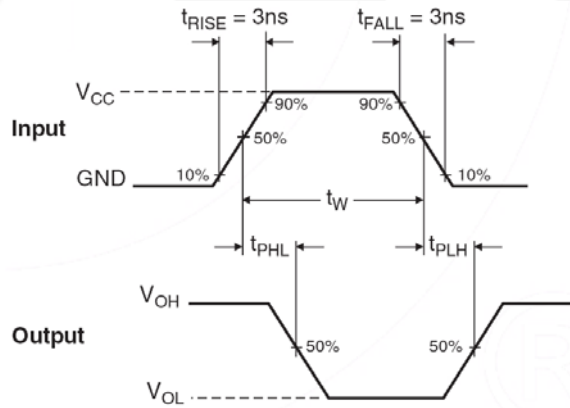
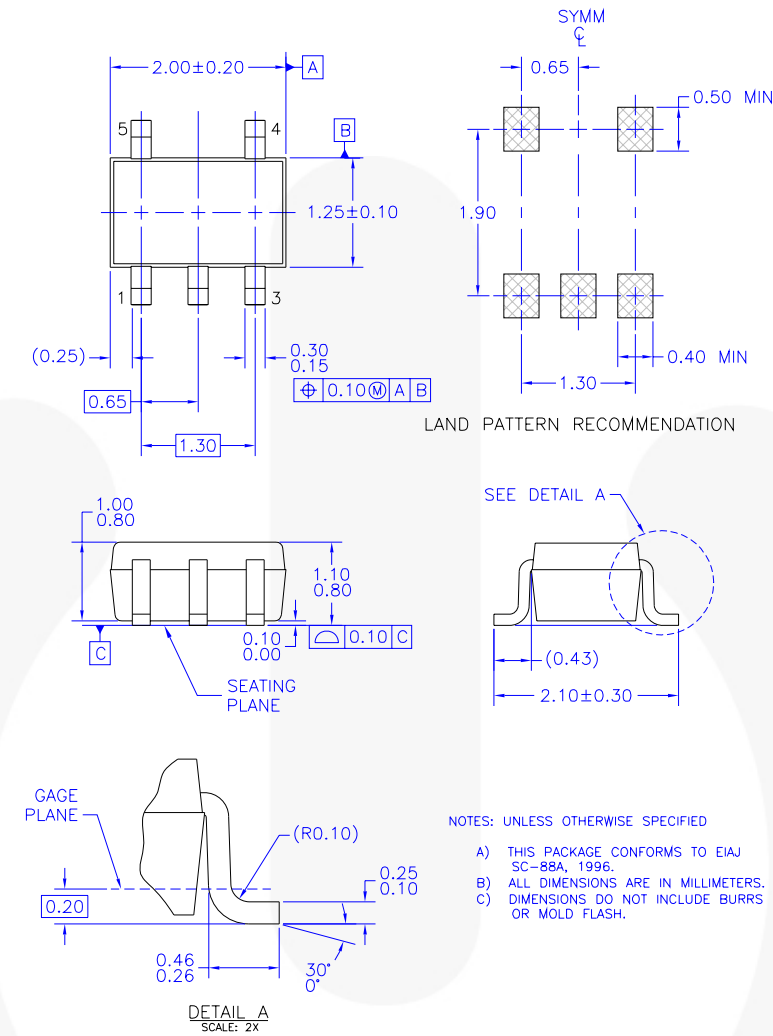

Figure 5. AC Waveforms

Symbol	V _{CC}					
	3.3V ± 0.3V	2.5V ± 0.2V	1.8V ± 0.15V	1.5V ± 0.1V	1.2V ± 0.1V	0.9V
V _{mi}	1.5V	V _{CC} /2	V _{CC} /2	V _{CC} /2	V _{CC} /2	V _{CC} /2
V _{mo}	1.5V	V _{CC} /2	V _{CC} /2	V _{CC} /2	V _{CC} /2	V _{CC} /2

Physical Dimensions



MAA05AREV5

Figure 6. 5-Lead, SC70, EIAJ SC-88a, 1.25mm Wide

Package drawings are provided as a service to customers considering Fairchild components. Drawings may change in any manner without notice. Please note the revision and/or date on the drawing and contact a Fairchild Semiconductor representative to verify or obtain the most recent revision. Package specifications do not expand the terms of Fairchild's worldwide terms and conditions, specifically the warranty therein, which covers Fairchild products.

Always visit Fairchild Semiconductor's online packaging area for the most recent package drawings:
<http://www.fairchildsemi.com/packaging/>

Tape and Reel Specifications

Please visit Fairchild Semiconductor's online packaging area for the most recent tape and reel specifications:
http://www.fairchildsemi.com/products/analog/pdf/sc70-5_tr.pdf

Package Designator	Tape Section	Cavity Number	Cavity Status	Cover Type Status
P5X	Leader (Start End)	125 (Typical)	Empty	Sealed
	Carrier	3000	Filled	Sealed
	Trailer (Hub End)	75 (Typical)	Empty	Sealed

Physical Dimensions



Notes:

1. CONFORMS TO JEDEC STANDARD M0-252 VARIATION UAAD
2. DIMENSIONS ARE IN MILLIMETERS
3. DRAWING CONFORMS TO ASME Y14.5M-1994

MAC06AREVC

Figure 7. 6-Lead, MicroPak™, 1.0mm Wide

Package drawings are provided as a service to customers considering Fairchild components. Drawings may change in any manner without notice. Please note the revision and/or date on the drawing and contact a Fairchild Semiconductor representative to verify or obtain the most recent revision. Package specifications do not expand the terms of Fairchild's worldwide terms and conditions, specifically the warranty therein, which covers Fairchild products.

Always visit Fairchild Semiconductor's online packaging area for the most recent package drawings:
<http://www.fairchildsemi.com/packaging/>

Tape and Reel Specifications

Please visit Fairchild Semiconductor's online packaging area for the most recent tape and reel specifications:
http://www.fairchildsemi.com/products/logic/pdf/micropak_tr.pdf

Package Designator	Tape Section	Cavity Number	Cavity Status	Cover Type Status
L6X	Leader (Start End)	125 (Typical)	Empty	Sealed
	Carrier	5000	Filled	Sealed
	Trailer (Hub End)	75 (Typical)	Empty	Sealed

Physical Dimensions

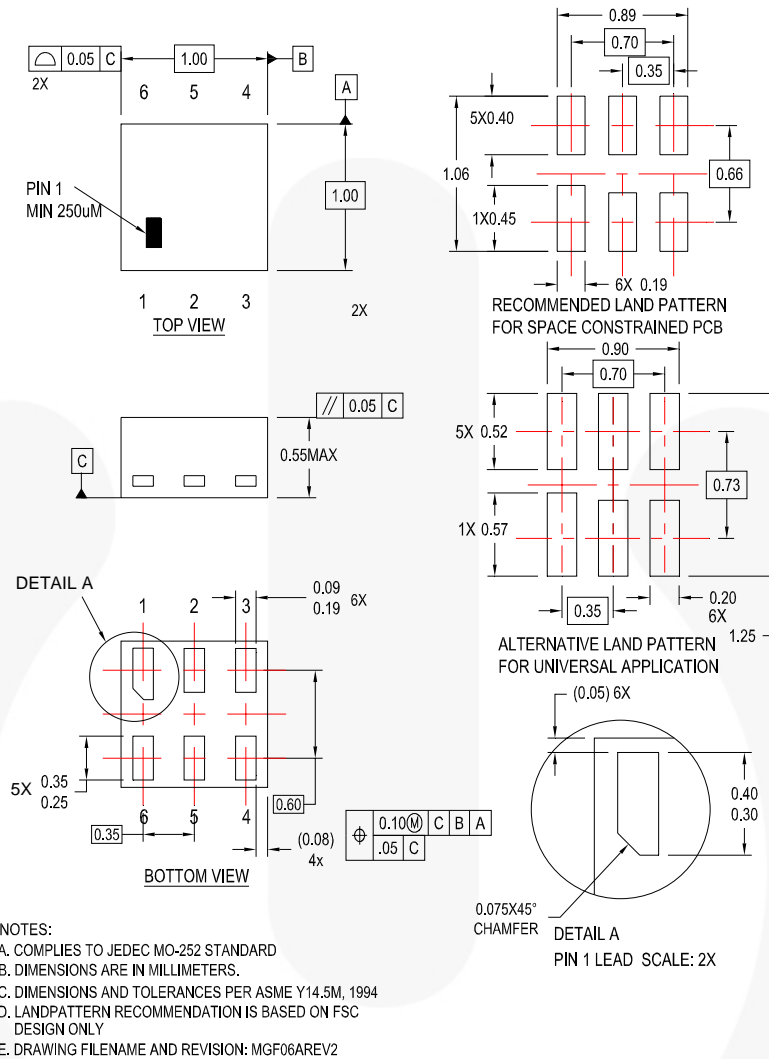

Figure 8. 6-Lead, MicroPak2, 1x1mm Body, .35mm Pitch

Package drawings are provided as a service to customers considering Fairchild components. Drawings may change in any manner without notice. Please note the revision and/or date on the drawing and contact a Fairchild Semiconductor representative to verify or obtain the most recent revision. Package specifications do not expand the terms of Fairchild's worldwide terms and conditions, specifically the warranty therein, which covers Fairchild products.

Always visit Fairchild Semiconductor's online packaging area for the most recent package drawings:
<http://www.fairchildsemi.com/packaging/>.

Tape and Reel Specifications







Please visit Fairchild Semiconductor's online packaging area for the most recent tape and reel specifications:
http://www.fairchildsemi.com/packaging/MicroPAK2_6L_tr.pdf.

Package Designator	Tape Section	Cavity Number	Cavity Status	Cover Type Status
FHX	Leader (Start End)	125 (Typical)	Empty	Sealed
	Carrier	5000	Filled	Sealed
	Trailer (Hub End)	75 (Typical)	Empty	Sealed



TRADEMARKS

The following includes registered and unregistered trademarks and service marks, owned by Fairchild Semiconductor and/or its global subsidiaries, and is not intended to be an exhaustive list of all such trademarks.

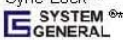
- | | | | |
|---|---|--|---|
| AccuPower™ | FPS™ | PowerTrench® | The Power Franchise® |
| Auto-SPM™ | F-PFS™ | PowerXS™ |  the power franchise |
| Build it Now™ | FRFET® | Programmable Active Droop™ | TinyBoost™ |
| CorePLUS™ | Global Power Resource™ | QFET® | TinyBuck™ |
| CorePOWER™ | Green FPS™ | QST™ | TinyCalc™ |
| CROSSVOLT™ | Green FPS™ e-Series™ | Quiet Series™ | TinyLogic® |
| CTL™ | Gmax™ | RapidConfigure™ | TINYOPTO™ |
| Current Transfer Logic™ | GTO™ |  TM | TinyPower™ |
| EcoSPARK® | IntelliMAX™ | Saving our world, 1mW/W/kW at a time™ | TinyPVM™ |
| EfficientMax™ | ISOPLANAR™ | SignalWise™ | TinyWire™ |
| EZSWTCH™ | MegaBuck™ | SmartMax™ | TriFault Detect™ |
|  ™ | MICROCOUPLER™ | SMART START™ | TRUECURRENT™ |
|  ® | MicroFET™ | SPM® | µSerDes™ |
| Fairchild® | MicroPak™ | STEALTH™ |  SerDes™ |
| Fairchild Semiconductor® | MillerDrive™ | SuperFET™ | UHC® |
| FACT Quiet Series™ | MotionMax™ | SuperSOT™3 | Ultra FRFET™ |
| FACT® | Motion-SPM™ | SuperSOT™6 | UniFET™ |
| FAST® | OPTOLOGIC® | SuperSOT™8 | VXC™ |
| FastvCore™ | OPTOPLANAR® | SupreMOS™ | VisualMax™ |
| FETBench™ |  ™ | SyncFET™ | XS™ |
| FlashWriter® | PDP-SPM™ | Sync-Lock™ | |
| | Power-SPM™ |  SYSTEM GENERAL | |

* Trademarks of System General Corporation, used under license by Fairchild Semiconductor.

DISCLAIMER

FAIRCHILD SEMICONDUCTOR RESERVES THE RIGHT TO MAKE CHANGES WITHOUT FURTHER NOTICE TO ANY PRODUCTS HEREIN TO IMPROVE RELIABILITY, FUNCTION, OR DESIGN. FAIRCHILD DOES NOT ASSUME ANY LIABILITY ARISING OUT OF THE APPLICATION OR USE OF ANY PRODUCT OR CIRCUIT DESCRIBED HEREIN; NEITHER DOES IT CONVEY ANY LICENSE UNDER ITS PATENT RIGHTS, NOR THE RIGHTS OF OTHERS. THESE SPECIFICATIONS DO NOT EXPAND THE TERMS OF FAIRCHILD'S WORLDWIDE TERMS AND CONDITIONS, SPECIFICALLY THE WARRANTY THEREIN, WHICH COVERS THESE PRODUCTS.

LIFE SUPPORT POLICY

FAIRCHILD'S PRODUCTS ARE NOT AUTHORIZED FOR USE AS CRITICAL COMPONENTS IN LIFE SUPPORT DEVICES OR SYSTEMS WITHOUT THE EXPRESS WRITTEN APPROVAL OF FAIRCHILD SEMICONDUCTOR CORPORATION.

As used herein:

1. Life support devices or systems are devices or systems which, (a) are intended for surgical implant into the body or (b) support or sustain life, and (c) whose failure to perform when properly used in accordance with instructions for use provided in the labeling, can be reasonably expected to result in a significant injury of the user.
2. A critical component in any component of a life support, device, or system whose failure to perform can be reasonably expected to cause the failure of the life support device or system, or to affect its safety or effectiveness.

ANTI-COUNTERFEITING POLICY

Fairchild Semiconductor Corporation's Anti-Counterfeiting Policy. Fairchild's Anti-Counterfeiting Policy is also stated on our external website, www.fairchildsemi.com, under Sales Support.

Counterfeiting of semiconductor parts is a growing problem in the industry. All manufacturers of semiconductor products are experiencing counterfeiting of their parts. Customers who inadvertently purchase counterfeit parts experience many problems such as loss of brand reputation, substandard performance, failed applications, and increased cost of production and manufacturing delays. Fairchild is taking strong measures to protect ourselves and our customers from the proliferation of counterfeit parts. Fairchild strongly encourages customers to purchase Fairchild parts either directly from Fairchild or from Authorized Fairchild Distributors who are listed by country on our web page cited above. Products customers buy either from Fairchild directly or from Authorized Fairchild Distributors are genuine parts, have full traceability, meet Fairchild's quality standards for handling and storage and provide access to Fairchild's full range of up-to-date technical and product information. Fairchild and our Authorized Distributors will stand behind all warranties and will appropriately address any warranty issues that may arise. Fairchild will not provide any warranty coverage or other assistance for parts bought from Unauthorized Sources. Fairchild is committed to combat this global problem and encourage our customers to do their part in stopping this practice by buying direct or from authorized distributors.

PRODUCT STATUS DEFINITIONS

Definition of Terms

Datasheet Identification	Product Status	Definition
Advance Information	Formative / In Design	Datasheet contains the design specifications for product development. Specifications may change in any manner without notice.
Preliminary	First Production	Datasheet contains preliminary data; supplementary data will be published at a later date. Fairchild Semiconductor reserves the right to make changes at any time without notice to improve design.
No Identification Needed	Full Production	Datasheet contains final specifications. Fairchild Semiconductor reserves the right to make changes at any time without notice to improve the design.
Obsolete	Not In Production	Datasheet contains specifications on a product that is discontinued by Fairchild Semiconductor. The datasheet is for reference information only.

Rev. 142