

# Square Trimming Potentiometer – 3386

# TSR-3386

## 玻璃釉微調電位器

- 單圈的/金屬陶瓷/工業用/密封  
(Single Turn/ Cermet/ Industrial/ Sealed)
- 多種引線的安裝尺寸  
(Many Terminal Styles)

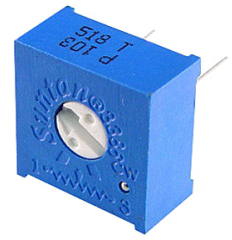

電氣特性 Electrical Characteristics	
標稱阻值範圍 Standard Resistance Range	10Ω - 5MΩ
阻值允許偏差 Resistance Tolerance	±10%
終端電阻 Absolute Minimum Resistance	≤1% R 或 10n
接觸電阻變化 Contact Resistance Variation	CRV≤3%
絕緣電阻 Insulation Resistance	R <sub>I</sub> ≥1GΩ(100Vac)
耐電壓 Withstand Voltage	600Vac
有效行程 Effective Travel	300° ± 10°

環境特性 Environmental Characteristics	
額定功率 Power Rating (315volts max)	0.5W@70°C, 0W@125°C
溫度範圍 Temperature Range	-55°C ~ +125°C
溫度系數 Temperature Coefficient	250 ±或±100ppm/°C
溫度變化 Temperature Variation	-55°C, 30min, +125°C 30min, 循環 5 次 5 cycles ΔR≤5%R, Δ(Uab/Uac)≤10%
碰撞 Collision	100m/s <sup>2</sup> , 4000cycles, ΔR≤2%R
70°C 耐久性 Electrical Endurance at 70°C	0.5W@70°C, 1000h ΔR≤10%R Δ(Uab/Uac)≤10%, CRV≤3% or 5Ω
機械壽命 Rotational Life	200 周 (200 cycles) ΔTR≤10%R, CRV≤3% or 5n

物理特性 Physical Characteristics	
起動力矩 Starting Torque	≤35mN·m
標誌 Marking	阻值允許偏差(±10%不標注) 阻值代碼、產品型號 Resistance Tolerance (When no identification, it is of ± 10%) Resistance Code, Model
標準包裝 Standard Packaging	50 只/管 (50pcs, per tube)

### 共有尺寸 Common Dimensions

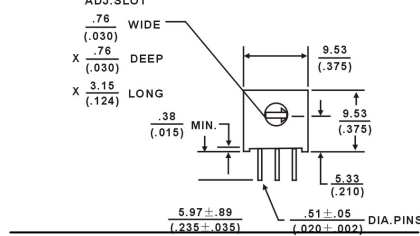

TSR-3386B

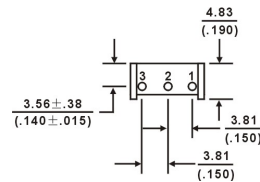

TSR-3386C

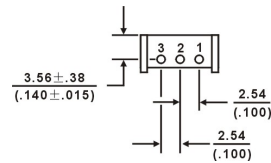

TSR-3386H

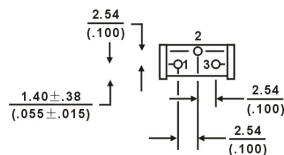

TSR-3386J

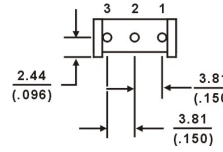

TSR-3386S

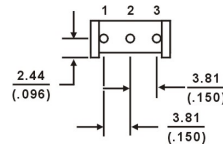

TSR-3386W

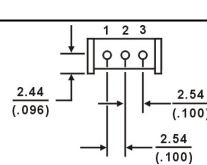

TSR-3386X

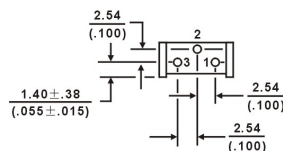

### 訂購指南 How to Order

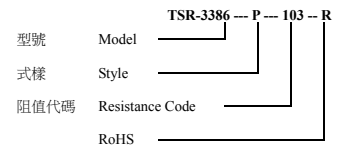

### 電刷 WIPER 2(d)

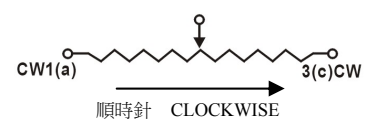

圖中公差：除注明外均為±0.25  
Tolerance is ±0.25 if no identification

### 阻值代碼表

#### Standard Resistance table

Resistance(Ohms)	Resistance Code
10	100
20	200
50	500
100	101
150	151
200	201
250	251
300	301
470	471
500	501
680	681
1,000	102
1,500	152
2,000	202
2,200	222
2,500	252
3,000	302
4,700	472
5,000	502
6,800	682
10,000	103
15,000	153
20,000	203
22,000	223
25,000	253
30,000	303
33,000	333
47,000	473
50,000	503
68,000	683
100,000	104
150,000	154
200,000	204
220,000	224
250,000	254
300,000	304
330,000	334
470,000	474
500,000	504
680,000	684
1,000,000	105
2,000,000	205
2,200,000	225
5,000,000	505

可按用戶要求提供特殊規格  
Special resistances available.

# TSR-3386

共有尺寸 Common Dimensions

頂調式

Top Adjust

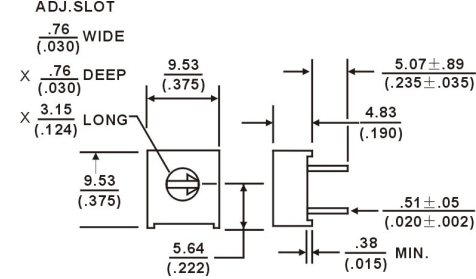

TSR-3386F

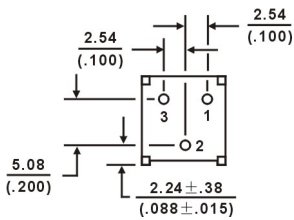

TSR-3386K

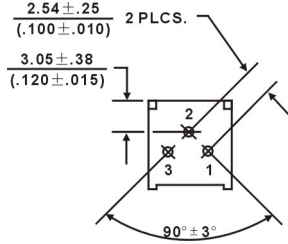

TSR-3386M

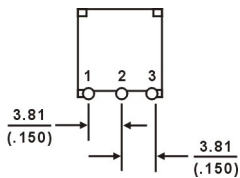

TSR-3386P

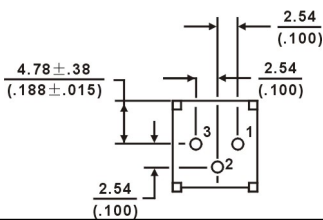

TSR-3386R

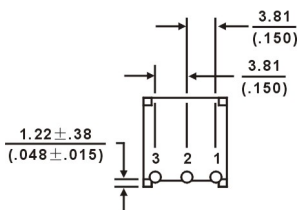

TSR-3386T

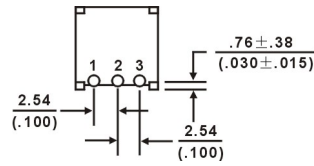

TSR-3386U

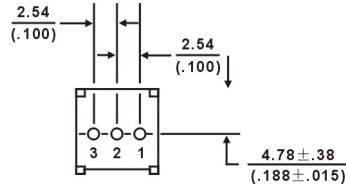

TSR-3386Y

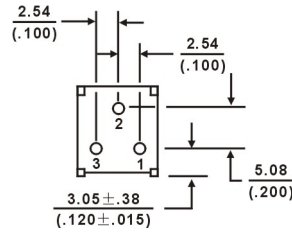

TSR-3386G

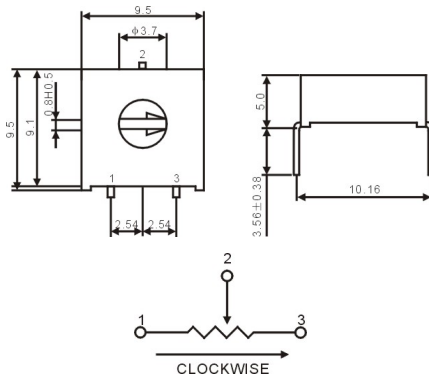

TSR-3386V

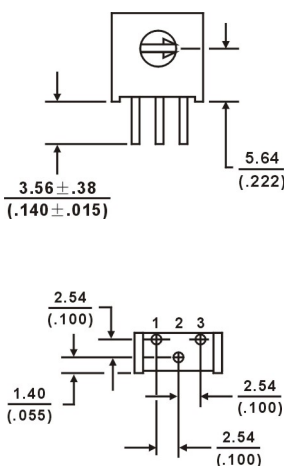

TSR-3386(STYLE)-EY5-(RESISTANCE CODE)

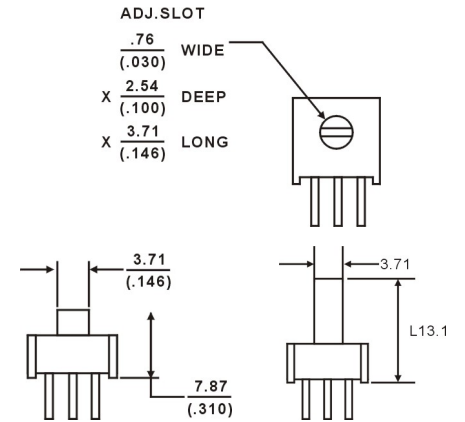

TSR-3386(STYLE)-EY5-(RESISTANCE CODE)-T

The Model 3386 is available with a knob for finger adjustment. Add suffix letter "T" to order code.

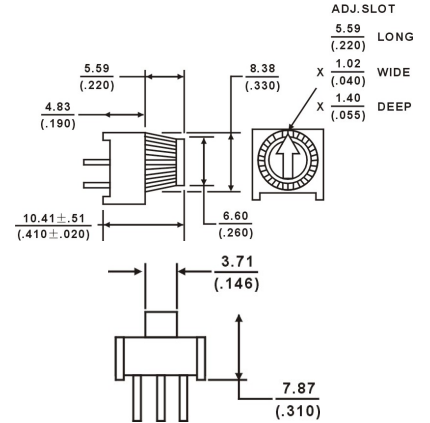

TSR-3386F,K,P,R,U,Y-EY5 (RESISTANCE CODE)-L

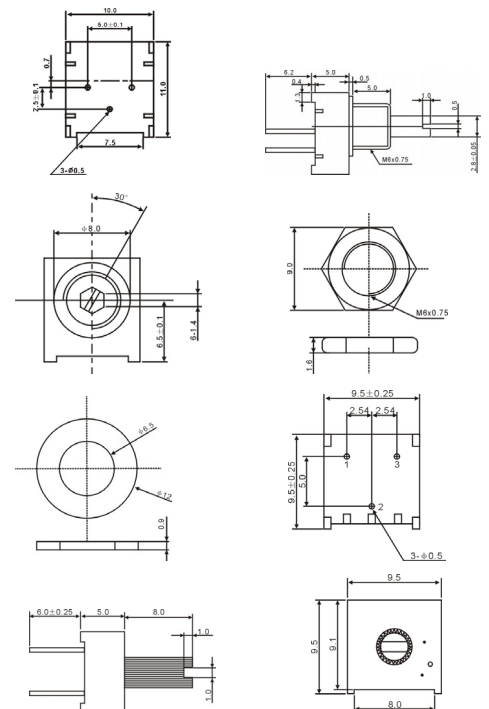

Note: Specification are subject to change without notice. For more detail and update, please visit our website.