

PLEASE CHECK WWW.MOLEX.COM FOR LATEST PART INFORMATION

Part Number: [0855025010](#)
Status: **Active**
Overview: [modular_plugs_jacks](#)
Description: Modular Jack, Right Angle, Low Profile, SMT, 6/4, Pin-in-Hole- Reflow

Documents:

3D Model	Product Specification PS-85502-001 (PDF)
Drawing (PDF)	RoHS Certificate of Compliance (PDF)
Application Specification (PDF)	

Agency Certification

UL E107635

General

Product Family	Modular Jacks/Plugs
Series	85502
Comments	Pin and Paste
Component Type	PCB Jack
Magnetic	No
Overview	modular_plugs_jacks
Performance Category	3
Power over Ethernet (PoE)	N/A
Product Name	RJ11

Physical

Boot Color	N/A
Color - Resin	Black
Durability (mating cycles max)	500
Flammability	94V-0
Inverted / Top Latch	No
Lightpipes/LEDs	None
Material - Metal	Brass
Material - Plating Mating	Gold
Material - Plating Termination	Tin
Material - Resin	High Temperature Thermoplastic
Orientation	Right Angle (Side Entry)
PCB Locator	Yes
PCB Retention	Yes
PCB Thickness Recommended (in)	0.062 In
PCB Thickness Recommended (mm)	1.57 mm
Packaging Type	Embossed Tape on Reel
Pitch - Mating Interface (in)	0.040 In
Pitch - Mating Interface (mm)	1.02 mm
Pitch - Term. Interface (in)	0.050 In
Pitch - Term. Interface (mm)	1.27 mm
Plating min: Mating (µin)	120.00, 50.8
Plating min: Mating (µm)	1.27, 3.000
Plating min: Termination (µin)	120.00, 76
Plating min: Termination (µm)	1.9, 3.00
Ports	1
Positions / Loaded Contacts	6/4
Surface Mount Compatible (SMC)	Yes
Temperature Range - Operating	-40°C to +80°C
Termination Interface: Style	Surface Mount
Waterproof / Dustproof	No
Wire/Cable Type	N/A

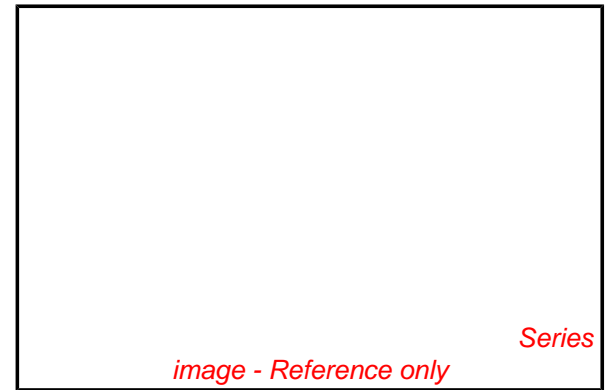

EU RoHS

**ELV and RoHS
Compliant**
**REACH SVHC
Contains SVHC: No**
**Halogen-Free
Status**

China RoHS



**Need more information on product
environmental compliance?**

Email productcompliance@molex.com
 For a multiple part number RoHS Certificate of
 Compliance, [click here](#)

Please visit the [Contact Us](#) section for any
 non-product compliance questions.

Search Parts in this Series

[85502Series](#)

Mates With

FCC 68 Plugs

Electrical

Current - Maximum per Contact	1.5A
Shielded	No
Voltage - Maximum	125V AC (RMS)

Solder Process Data

Duration at Max. Process Temperature (seconds)	45
Lead-free Process Capability	Reflow Capable (SMT only)
Max. Cycles at Max. Process Temperature	3
Process Temperature max. C	260

Material Info**Reference - Drawing Numbers**

Packaging Specification	PK-85502
Product Specification	PS-85502-001
Sales Drawing	SD-85502-103

This document was generated on 06/07/2010

PLEASE CHECK WWW.MOLEX.COM FOR LATEST PART INFORMATION

10 9 8 7 6 5 4 3 2 1

F
E
D
C
B
A

F
E
D
C
B
A

NOTES:

1- MATERIAL:

HOUSING: LCP GLASS FILLED UL 94V0, COLOUR: BLACK

TERMINAL: BRASS PLATED WITH:

0.00127/.000050 MIN GOLD IN CONTACT AREA,
0.00190/.000075 MIN PURE TIN IN TAIL AREA,
BOTH OVER 0.00127/.000050 MIN NICKEL OVERALL.

SOLDER PEGS: BRASS PLATED WITH 0.0020/.000078 MIN TIN.

2- JACK FOR MATING WITH F.C.C.68 PLUGS.
(MOLEX 90075 SERIES).

3- PRODUCT SPECIFICATION: MOLEX PS-85502-001

4 - POLYIMIDE ADHESIVE TAPE FOR PICK & PLACE SURFACE.
THICKNESS: 125 μm /4921 μm

5 - PACKAGING SPECIFICATION: MOLEX PK-85502.
(BLISTER PACKAGING).

6 - COPLANARITY OF SIGNAL LEADS: 0.10/.004

7 - SEE DIMENSIONS IN CHART ON SHEET 2.

8 - P.C. BOARD THICKNESS: 1.57/.062

9- MANUFACTURING I.D. CAN BE EITHER MG, MXF OR MXI.

10- APPLICATION SPEC: AS-85513-001

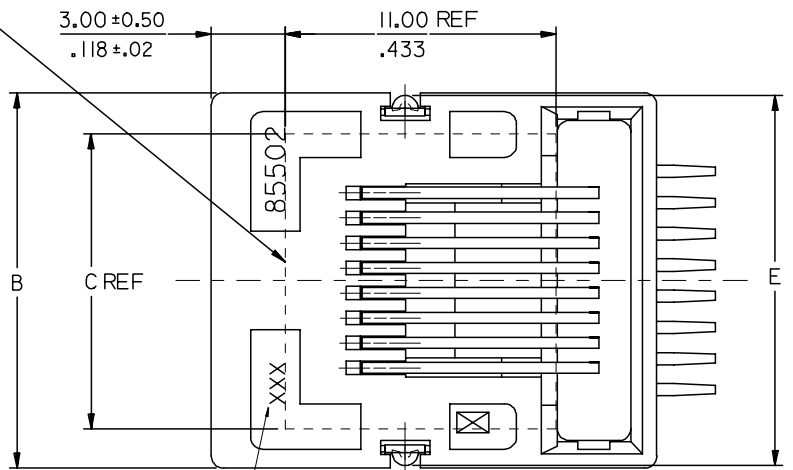
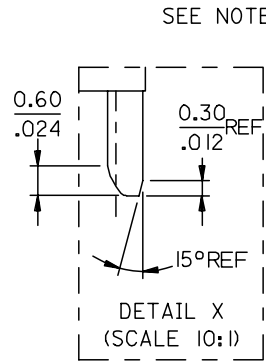
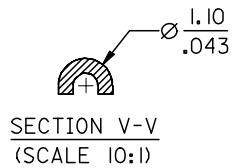

NOTE 9.

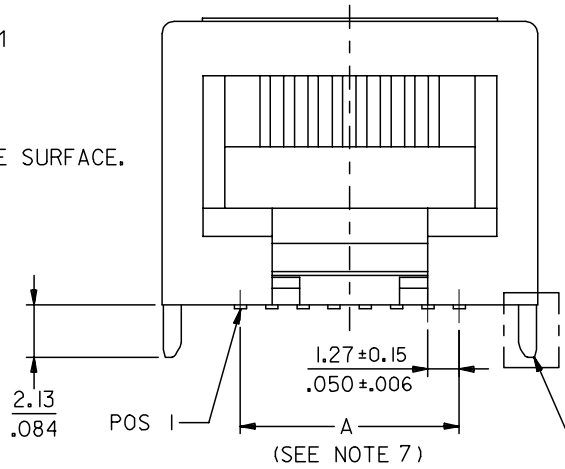

(SEE NOTE 7)

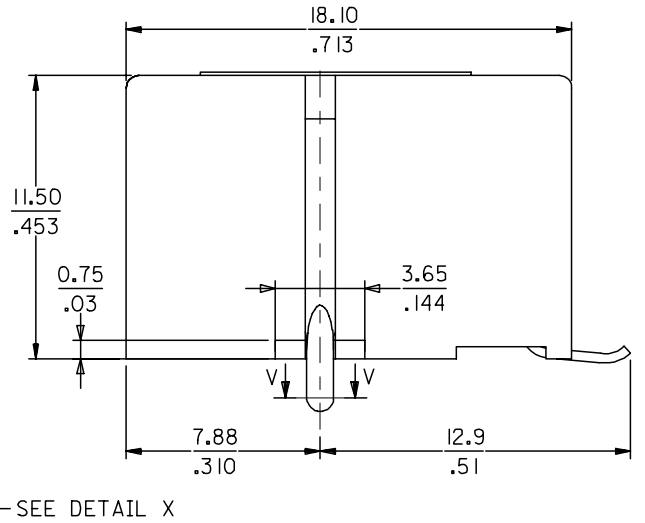

SEE DETAIL X

MODIFIED MATL EC NO: E2007-0717 DRWN:DBYRNES CHKD: APPR:EOMAHONY 2007/02/15 2007/02/15 2007/02/15	QUALITY SYMBOLS ▽=0 ▽=0	GENERAL TOLERANCES (UNLESS SPECIFIED)		DIMENSION STYLE MM/IN	SCALE 5:1	DESIGN UNITS METRIC	THIRD ANGLE PROJECTION		
		4 PLACES ± --- ± ---	3 PLACES ± --- ± .010	2 PLACES ± 0.25 ± .014	1 PLACE ± 0.35 ± ---	ANGULAR ± 2 °	DRAWN BY DB	DATE 2006/06/12	TITLE R/A LOW PROFILE P.C.JACK SMT; 4,6 & 8 CKTS WITH THROUGH HOLE SOLDER PEGS
		DRAFT WHERE APPLICABLE MUST REMAIN WITHIN DIMENSIONS		SEE CHART SHT 2	MATERIAL NO.	DOCUMENT NO. SD-85502-103	SHEET NO. 1 OF 2		
		THIS DRAWING CONTAINS INFORMATION THAT IS PROPRIETARY TO MOLEX INCORPORATED AND SHOULD NOT BE USED WITHOUT WRITTEN PERMISSION							

9 8 7 6 5 4 3 2 1

NOTE 1:
TWO OPTIONAL HOLES FOR THE 8 POSITION-VERSION FOR THE COMPATIBILITY
WITH THE INTERNAL SHIELDED VERSION.

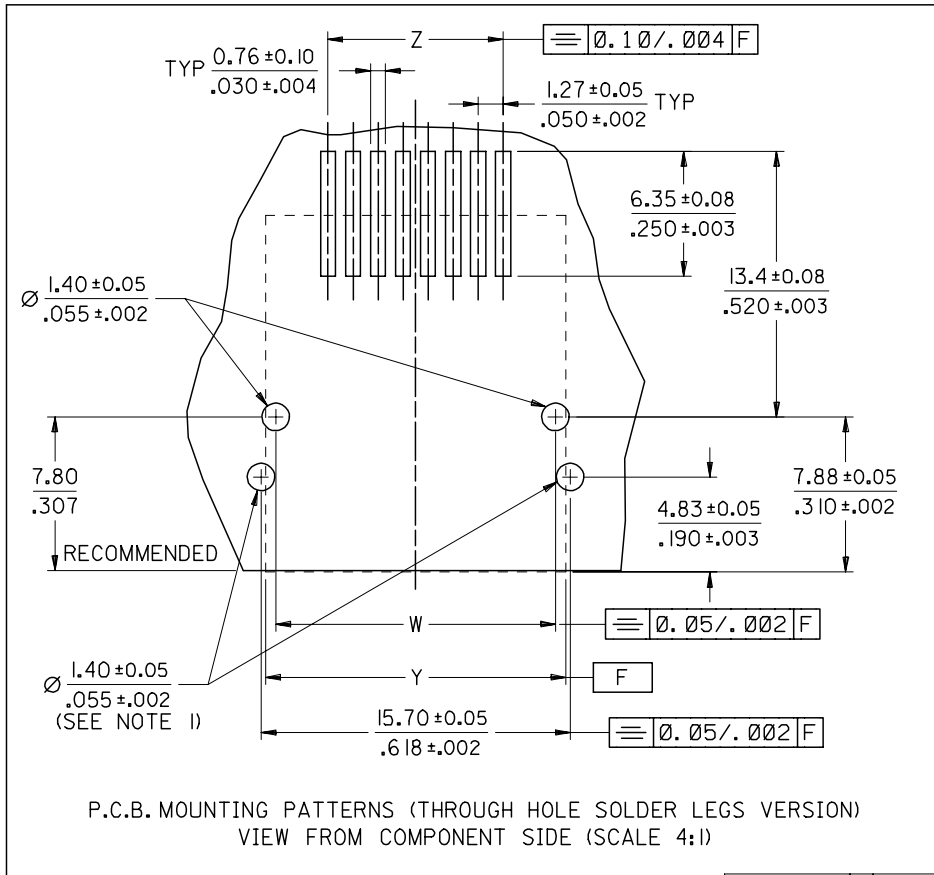

STANDARD VERSION	PART NUMBERS FOR SMT JACK WITH THROUGH HOLE SOLDER PEGS								
	HOUSING COLOR	POS 4	TOOLED	POS 6	TOOLED	POS 8	TOOLED		
	BLACK	4 CKTS		4 CKTS		6 CKTS		8 CKTS	
		85502-5009		85502-5010		85502-5011		85502-5012	

DIM	TYPE	POS 4	POS 6		POS 8
		4 CKTS	4 CKTS	6 CKTS	8 CKTS
A	±0.15 / .006	3.81 / .150	3.81 / .150	6.35 / .250	8.89 / .350
B		11.18 / .440	13.21 / .520	13.21 / .520	15.24 / .600
C (REF)		8.50 / .335	8.50 / .335	8.50 / .335	12.00 / .472
E		11.08 / .436	13.11 / .516	13.11 / .516	15.14 / .596
W	±0.05 / .002	10.13 / .399	12.16 / .479	12.16 / .479	14.19 / .559
Y (REF)		11.18 / .440	13.21 / .520	13.21 / .520	15.24 / .600
Z	±0.05 / .002	3.81 / .150	3.81 / .150	6.35 / .250	8.89 / .350

SEE SHEET 1
EC NO: E2007-0717
DRWN:DBYRNES
CHKD:
APPR:EOMAHONY

2007/02/15
2007/02/15
2007/02/15
QUALITY SYMBOLS
▽=0
△=0

GENERAL TOLERANCES (UNLESS SPECIFIED)

	mm	INCH
4 PLACES	±---	±---
3 PLACES	±---	±.010
2 PLACES	±0.25	±.014
1 PLACE	±0.35	±---

ANGULAR ± 2 °

DRAFT WHERE APPLICABLE
MUST REMAIN WITHIN DIMENSIONS

DIMENSION STYLE
MM/IN

DRAWN BY
DB

CHECKED BY
EOMAHONY

APPROVED BY
EOMAHONY

MATERIAL NO.

DATE
2006/06/12
2006/06/15
2006/06/15

SCALE
5:1

DESIGN UNITS
METRIC

THIRD ANGLE PROJECTION

TITLE
RIGHT ANGLE LOW PROFILE
SMT PC JACK WITH THROUGH
HOLE SOLDER PEGS

MOLEX INCORPORATED

DOCUMENT NO.
SD-85502-103

SHEET NO.
2 OF 2

THIS DRAWING CONTAINS INFORMATION THAT IS PROPRIETARY TO MOLEX INCORPORATED AND SHOULD NOT BE USED WITHOUT WRITTEN PERMISSION