

PLEASE CHECK WWW.MOLEX.COM FOR LATEST PART INFORMATION

Part Number: [0781271298](#)
Status: **Active**
Overview: ffc fpc smt
Description: 0.50mm (.020") Pitch FFC/FPC Connector, SMT, Non ZIF, Vertical, Reverse, Gold Plating, 29 Circuits, Lead Free

Documents:

[3D Model](#) [Product Specification PS-78119-001 \(PDF\)](#)
[Drawing \(PDF\)](#) [RoHS Certificate of Compliance \(PDF\)](#)

Agency Certification

CSA LR19980
 UL E29179

General

Product Family FFC/FPC Connectors
 Series [78127](#)
 Overview [ffc fpc smt](#)
 Product Name N/A

Physical

Circuits (Loaded) 29
 Circuits (maximum) 29
 Color - Resin Natural
 Contact Position N/A
 Durability (mating cycles max) 20
 Entry Angle Vertical
 Flammability 94V-0
 Mated Height (in) 0.161 In
 Mated Height (mm) 4.10 mm
 Material - Metal Copper Alloy
 Material - Plating Mating Gold, Nickel
 Number of Rows 1
 Orientation Vertical
 PCB Locator No
 PCB Retention None
 Packaging Type Embossed Tape on Reel
 Pitch - Mating Interface (in) 0.020 In
 Pitch - Mating Interface (mm) 0.50 mm
 Pitch - Term. Interface (in) 0.020 In
 Pitch - Term. Interface (mm) 0.50 mm
 Polarized to PCB No
 Stackable No
 Temperature Range - Operating -40°C to +85°C
 Termination Interface: Style Surface Mount
 Wire/Cable Type FFC/FPC

Electrical

Current - Maximum per Contact 0.5A
 Voltage - Maximum 50V AC

Material Info

Reference - Drawing Numbers

Product Specification PS-78119-001
 Sales Drawing SD-78127-001

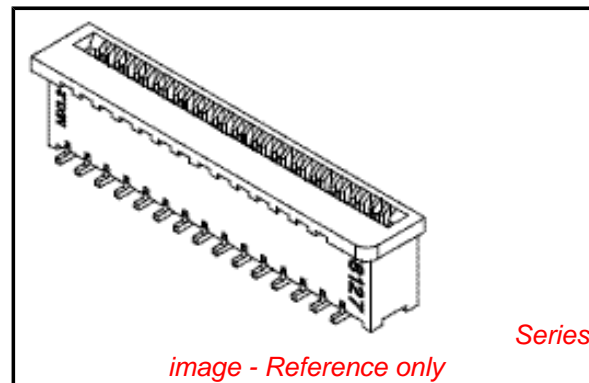

EU RoHS

**ELV and RoHS
 Compliant**
**REACH SVHC
 Contains SVHC: No**
**Halogen-Free
 Status
 Not Reviewed**

China RoHS



**Need more information on product
 environmental compliance?**

Email productcompliance@molex.com
 For a multiple part number RoHS Certificate of
 Compliance, [click here](#)

Please visit the [Contact Us](#) section for any
 non-product compliance questions.

Search Parts in this Series

78127Series

Mates With

Standard FFC/FPC Cables

This document was generated on 06/07/2010

PLEASE CHECK WWW.MOLEX.COM FOR LATEST PART INFORMATION

10 9 8 7 6 5 4 3 2 1

F

E

D

C

B

A

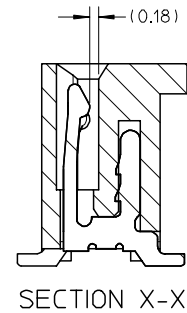
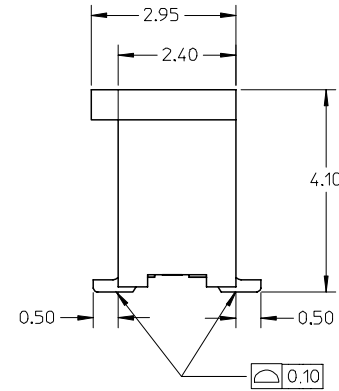
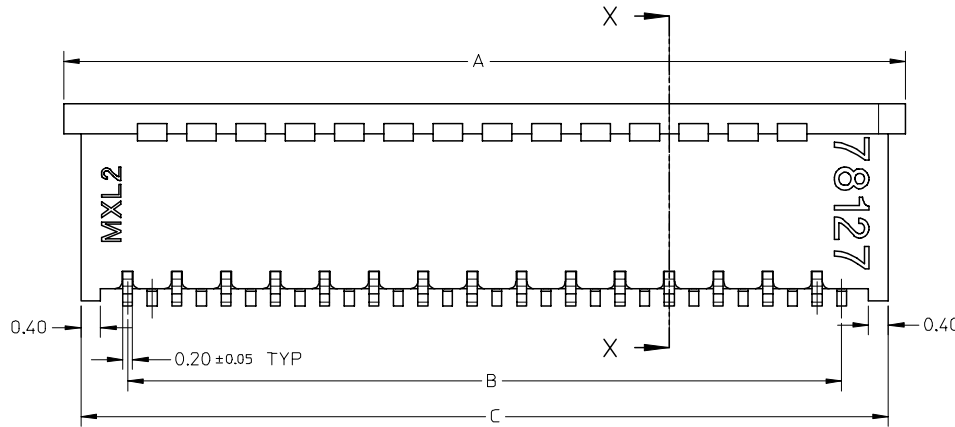
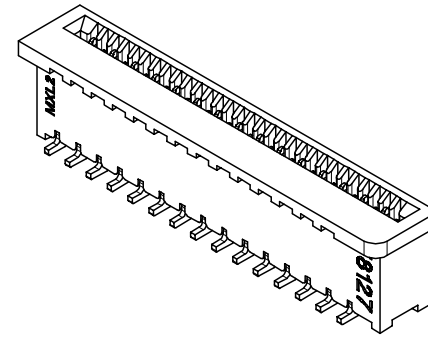
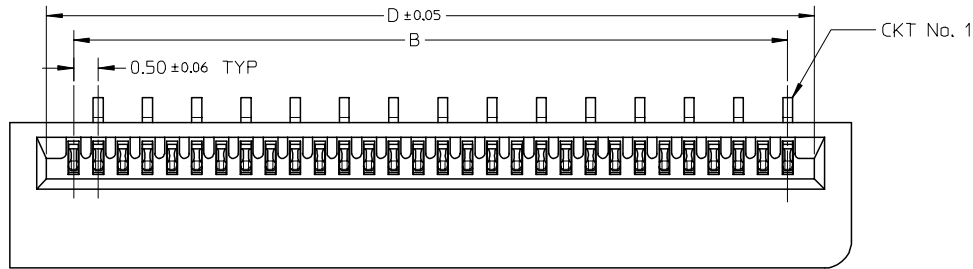

NOTE:

1. MATERIAL:
HOUSING: PA46 GLASS FILLED, UL94V-0, COLOR: NATURAL
TERMINAL: COPPER ALLOY
2. PLATING:
1) 0.10 μm MIN. GOLD PLATING OVER NICKEL PLATING OVERALL
2) 1-3 μm TIN-BISMUTH PLATING OVER NICKEL PLATING OVERALL
3. PRODUCT SPECIFICATION: PS-78119-001
4. PRODUCT ARE PACKED IN TAPE & REEL.

REVISED	DESCRIPTION
EC NO: S2007-0721	2007/03/05
DRWN: BOKOK	2007/03/05
CHKD: CGOH	
APPR: KCLING	2007/03/05
A1	REV

QUALITY SYMBOLS	▽=0
	∇=0

GENERAL TOLERANCES (UNLESS SPECIFIED)	
	mm INCH
4 PLACES	± --- ± ---
3 PLACES	± --- ± ---
2 PLACES	± 0.15 ± ---
1 PLACE	± --- ± ---
ANGULAR ± 3 °	
DRAFT WHERE APPLICABLE MUST REMAIN WITHIN DIMENSIONS	

DIMENSION STYLE	
MM ONLY	
DRAWN BY	DATE
YLQ1A0	2006/05/05
CHECKED BY	DATE
BOKOK	2006/06/06
APPROVED BY	DATE
PTL IM	2006/06/06
MATERIAL NO.	
SEE TABLE	
SIZE	
A3	

SCALE	DESIGN UNITS	THIRD ANGLE PROJECTION	
NTS	METRIC		
TITLE		0.50MM PITCH, FPC CONN. NON-ZIF, SMT	
MOLEX INCORPORATED			
DOCUMENT NO.	SHEET NO.		
SD-78127-001	1 OF 7		
THIS DRAWING CONTAINS INFORMATION THAT IS PROPRIETARY TO MOLEX INCORPORATED AND SHOULD NOT BE USED WITHOUT WRITTEN PERMISSION			

9 8 7 6 5 4 3 2 1

10 9 8 7 6 5 4 3 2 1

F

E

D

C

B

A

F

E

D

C

B

A

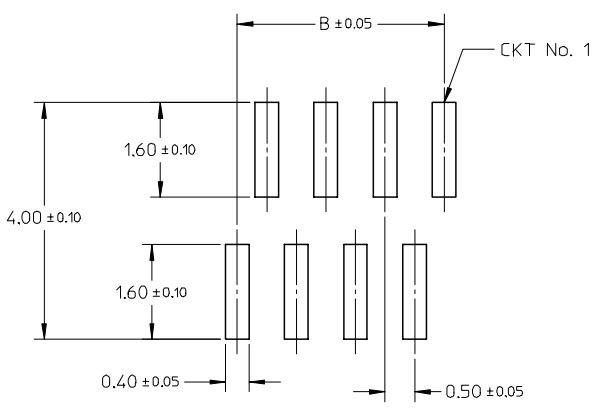

RECOMMENDED PCB LAYOUT

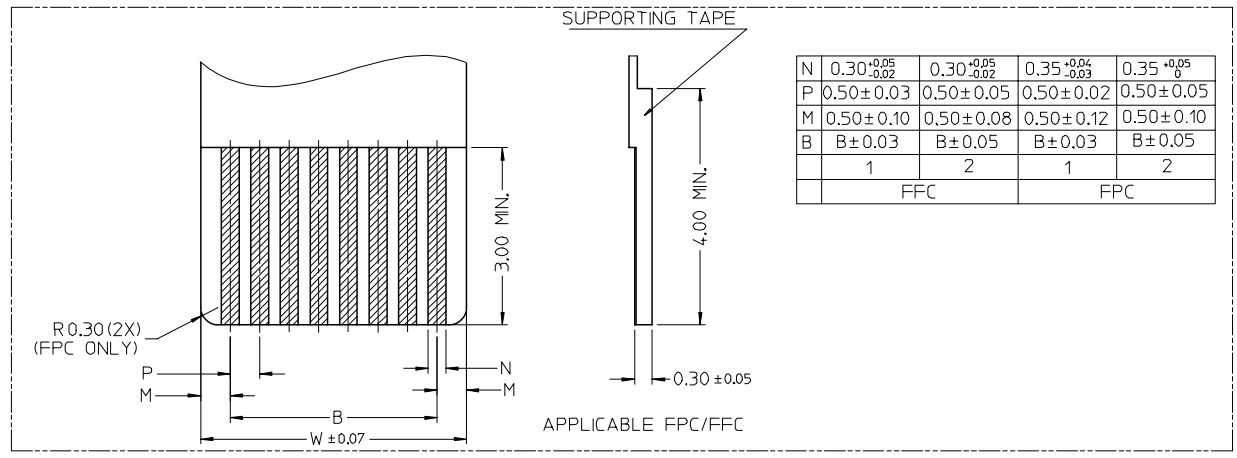

N	0.30 ^{+0.05} / _{-0.02}	0.30 ^{+0.05} / _{-0.02}	0.35 ^{+0.04} / _{-0.03}	0.35 ^{+0.05} / ₀
P	0.50 ± 0.03	0.50 ± 0.05	0.50 ± 0.02	0.50 ± 0.05
M	0.50 ± 0.10	0.50 ± 0.08	0.50 ± 0.12	0.50 ± 0.10
B	B ± 0.03	B ± 0.05	B ± 0.03	B ± 0.05
	1	2	1	2
	FFC		FPC	

REVISED EC NO: S2007-0721 DRWN: BOKOK CHKD: CGOH APPR: KCLING	2007/03/05 2007/03/05 2007/03/05	QUALITY SYMBOLS ▽=0 ◁=0	GENERAL TOLERANCES (UNLESS SPECIFIED)		DIMENSION STYLE MM ONLY		SCALE NTS	DESIGN UNITS METRIC	THIRD ANGLE PROJECTION	
	4 PLACES ± --- ± --- 3 PLACES ± --- ± --- 2 PLACES ± 0.15 ± --- 1 PLACE ± --- ± ---		mm INCH	DRAWN BY YLQ1A0	DATE 2006/05/05	TITLE 0.50MM PITCH, FPC CONN. NON-ZIF, SMT				
	ANGULAR ± 3 °		CHECKED BY BOKOK	DATE 2006/06/06	MOLEX INCORPORATED					
	DRAFT WHERE APPLICABLE MUST REMAIN WITHIN DIMENSIONS		APPROVED BY PTLIM	DATE 2006/06/06	MATERIAL NO. SEE TABLE	DOCUMENT NO. SD-78127-001	SHEET NO. 2 OF 7			

9 8 7 6 5 4 3 2 1

GOLD PLATING TERMINAL ASSEMBLY PART NUMBERS

ASSY P/N W/O PACKAGING	CKT	DIM A	DIM B	DIM C	DIM D	PLATING TYPE
78127-0068	6	5.10	2.50	4.40	3.60	1
78127-0078	7	5.60	3.00	4.90	4.10	
78127-0088	8	6.10	3.50	5.40	4.60	
78127-0098	9	6.60	4.00	5.90	5.10	
78127-0108	10	7.10	4.50	6.40	5.60	
78127-0118	11	7.60	5.00	6.90	6.10	
78127-0128	12	8.10	5.50	7.40	6.60	
78127-0138	13	8.60	6.00	7.90	7.10	
78127-0148	14	9.10	6.50	8.40	7.60	
78127-0158	15	9.60	7.00	8.90	8.10	
78127-0168	16	10.10	7.50	9.40	8.60	
78127-0178	17	10.60	8.00	9.90	9.10	
78127-0188	18	11.10	8.50	10.40	9.60	
78127-0198	19	11.60	9.00	10.90	10.10	
78127-0208	20	12.10	9.50	11.40	10.60	
78127-0218	21	12.60	10.00	11.90	11.10	
78127-0228	22	13.10	10.50	12.40	11.60	
78127-0238	23	13.60	11.00	12.90	12.10	
78127-0248	24	14.10	11.50	13.40	12.60	
78127-0258	25	14.60	12.00	13.90	13.10	
78127-0268	26	15.10	12.50	14.40	13.60	
78127-0278	27	15.60	13.00	14.90	14.10	
78127-0288	28	16.10	13.50	15.40	14.60	
78127-0298	29	16.60	14.00	15.90	15.10	
78127-0308	30	17.10	14.50	16.40	15.60	

ASSY P/N W/O PACKAGING	CKT	DIM A	DIM B	DIM C	DIM D	PLATING TYPE
78127-0318	31	17.60	15.00	16.90	16.10	1
78127-0328	32	18.10	15.50	17.40	16.60	
78127-0338	33	18.60	16.00	17.90	17.10	
78127-0348	34	19.10	16.50	18.40	17.60	
78127-0358	35	19.60	17.00	18.90	18.10	
78127-0368	36	20.10	17.50	19.40	18.60	
78127-0378	37	20.60	18.00	19.90	19.10	
78127-0388	38	21.10	18.50	20.40	19.60	
78127-0398	39	21.60	19.00	20.90	20.10	
78127-0408	40	22.10	19.50	21.40	20.60	
78127-0418	41	22.60	20.00	21.90	21.10	
78127-0428	42	23.10	20.50	22.40	21.60	

REVISED EC NO: S2007-0721 DRWN: BOKOK CHKD: CGOH APPR: KCLING 2007/03/05 2007/03/05 2007/03/05	QUALITY SYMBOLS	GENERAL TOLERANCES (UNLESS SPECIFIED)	DIMENSION STYLE	SCALE	DESIGN UNITS	THIRD ANGLE PROJECTION
	$\nabla = 0$ $\sphericalangle = 0$	mm INCH 4 PLACES ± --- ± --- 3 PLACES ± --- ± --- 2 PLACES ± 0.15 ± --- 1 PLACE ± --- ± --- ANGULAR ± 3°	MM ONLY	NTS	METRIC	
	DESCRIPTION	DRAFT WHERE APPLICABLE MUST REMAIN WITHIN DIMENSIONS	DRAWN BY DATE YLQ1A0 2006/05/05 CHECKED BY DATE BOKOK 2006/06/06 APPROVED BY DATE PTL IM 2006/06/06	TITLE	0.50MM PITCH, FPC CONN. NON-ZIF, SMT	
	REV	SIZE	MATERIAL NO.	DOCUMENT NO.	MOLEX INCORPORATED	
A1	A3	SEE TABLE	SD-78127-001	SHEET NO. 3 OF 7		
THIS DRAWING CONTAINS INFORMATION THAT IS PROPRIETARY TO MOLEX INCORPORATED AND SHOULD NOT BE USED WITHOUT WRITTEN PERMISSION						

10 9 8 7 6 5 4 3 2 1

F

F

TIN-BISMUTH PLATING TERMINAL ASSEMBLY PART NUMBERS

ASSY P/N W/O PACKAGING	CKT	DIM A	DIM B	DIM C	DIM D	PLATING TYPE
78127-0069	6	5.10	2.50	4.40	3.60	2
78127-0079	7	5.60	3.00	4.90	4.10	
78127-0089	8	6.10	3.50	5.40	4.60	
78127-0099	9	6.60	4.00	5.90	5.10	
78127-0109	10	7.10	4.50	6.40	5.60	
78127-0119	11	7.60	5.00	6.90	6.10	
78127-0129	12	8.10	5.50	7.40	6.60	
78127-0139	13	8.60	6.00	7.90	7.10	
78127-0149	14	9.10	6.50	8.40	7.60	
78127-0159	15	9.60	7.00	8.90	8.10	
78127-0169	16	10.10	7.50	9.40	8.60	
78127-0179	17	10.60	8.00	9.90	9.10	
78127-0189	18	11.10	8.50	10.40	9.60	
78127-0199	19	11.60	9.00	10.90	10.10	
78127-0209	20	12.10	9.50	11.40	10.60	
78127-0219	21	12.60	10.00	11.90	11.10	
78127-0229	22	13.10	10.50	12.40	11.60	
78127-0239	23	13.60	11.00	12.90	12.10	
78127-0249	24	14.10	11.50	13.40	12.60	
78127-0259	25	14.60	12.00	13.90	13.10	
78127-0269	26	15.10	12.50	14.40	13.60	
78127-0279	27	15.60	13.00	14.90	14.10	
78127-0289	28	16.10	13.50	15.40	14.60	
78127-0299	29	16.60	14.00	15.90	15.10	
78127-0309	30	17.10	14.50	16.40	15.60	

ASSY P/N W/O PACKAGING	CKT	DIM A	DIM B	DIM C	DIM D	PLATING TYPE
78127-0319	31	17.60	15.00	16.90	16.10	2
78127-0329	32	18.10	15.50	17.40	16.60	
78127-0339	33	18.60	16.00	17.90	17.10	
78127-0349	34	19.10	16.50	18.40	17.60	
78127-0359	35	19.60	17.00	18.90	18.10	
78127-0369	36	20.10	17.50	19.40	18.60	
78127-0379	37	20.60	18.00	19.90	19.10	
78127-0389	38	21.10	18.50	20.40	19.60	
78127-0399	39	21.60	19.00	20.90	20.10	
78127-0409	40	22.10	19.50	21.40	20.60	
78127-0419	41	22.60	20.00	21.90	21.10	
78127-0429	42	23.10	20.50	22.40	21.60	

E

E

D

D

C

C

B

B

A

A

REVISED
EC NO: S2007-0721
DRWN: BOKOK
CHKD: CGOH
APPR: KCLING

QUALITY SYMBOLS
▽=0
▽C=0

GENERAL TOLERANCES (UNLESS SPECIFIED)

	mm	INCH
4 PLACES	± ---	± ---
3 PLACES	± ---	± ---
2 PLACES	± 0.15	± ---
1 PLACE	± ---	± ---

ANGULAR ± 3 °

DRAFT WHERE APPLICABLE
MUST REMAIN WITHIN DIMENSIONS

DIMENSION STYLE
MM ONLY

DRAWN BY
YLQIAO

CHECKED BY
BOKOK

APPROVED BY
PTL IM

MATERIAL NO.

SIZE
A3

SCALE
NTS

DESIGN UNITS
METRIC

THIRD ANGLE PROJECTION

TITLE
0.50MM PITCH, FPC CONN.
NON-ZIF, SMT

MOLEX INCORPORATED

DOCUMENT NO.
SD-78127-001

SHEET NO.
4 OF 7

THIS DRAWING CONTAINS INFORMATION THAT IS PROPRIETARY TO MOLEX INCORPORATED AND SHOULD NOT BE USED WITHOUT WRITTEN PERMISSION

9 8 7 6 5 4 3 2 1

EMBOSSED TYPE A

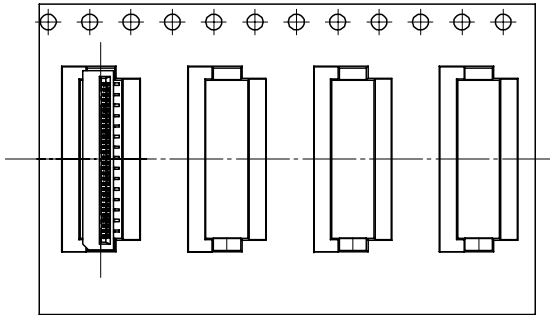

CUSTOMER
PULL OUT DIRECTION

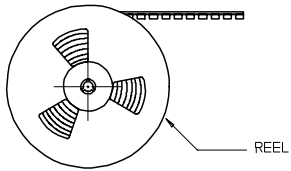

REEL

NOTES:

1. LEADER AND TRAILER TAPE

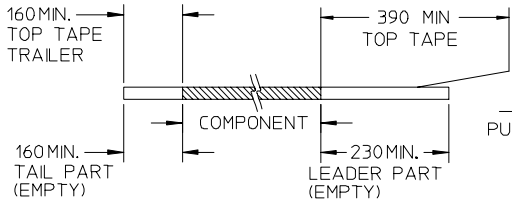

2. PEELING OFF FORCE OF THE TOP TAPE: 20-80gf.
(PEELING DIRECTION AS SHOWN IN FOLLOWING FIGURE)

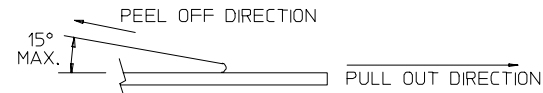

3. PACKAGING STANDARD IS AS PER EIA-481.

4. TAPE & REEL QUANTITY = 1000 PCS/REEL

EMBOSSED TYPE B

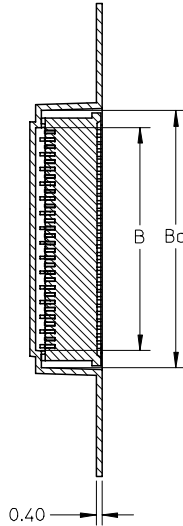
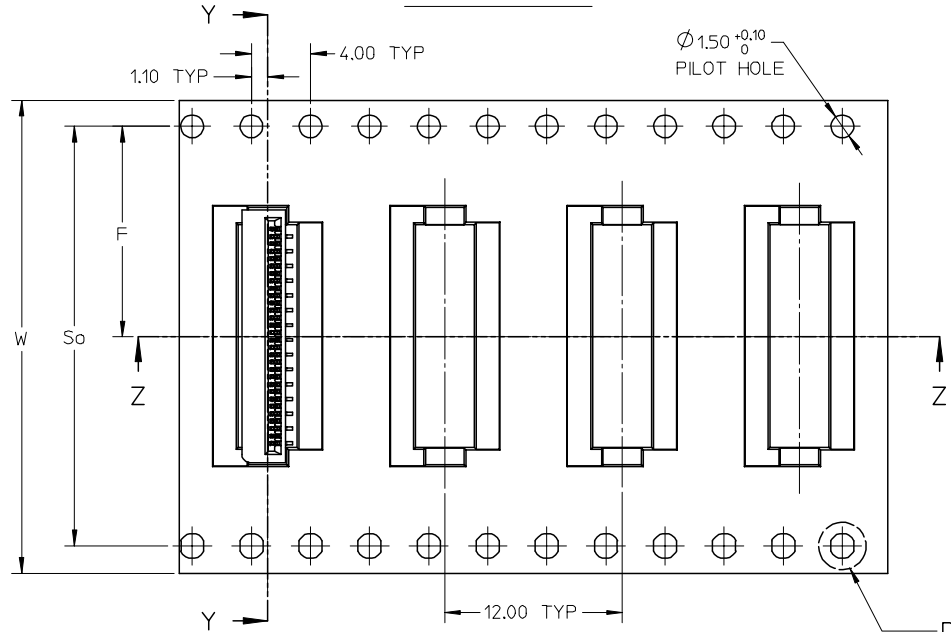

SECTION Y-Y

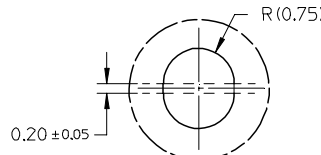

DETAIL 1

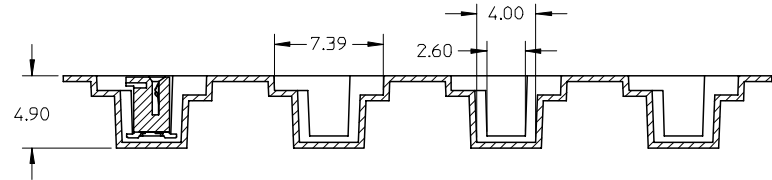

SECTION Z-Z

REVISED	EC NO: S2007-0721	2007/03/05	2007/03/05	2007/03/05	2007/03/05
DRWN: BOKOK	CHKD: CGOH	APPR: KCLING	DESCRIPTION		
A1	REV	QUALITY SYMBOLS			
		▽=0		▽=0	

GENERAL TOLERANCES (UNLESS SPECIFIED)		DIMENSION STYLE MM ONLY		SCALE NTS	DESIGN UNITS METRIC	THIRD ANGLE PROJECTION
4 PLACES	± ---	± ---	DRAWN BY YLQ1A0	DATE 2006/05/05	TITLE 0.50MM PITCH, FPC CONN. NON-ZIF, SMT	
3 PLACES	± ---	± ---	CHECKED BY BOKOK	DATE 2006/06/06	APPROVED BY PTL IM	
2 PLACES	± 0.15	± ---	DATE 2006/06/06		MATERIAL NO.	
1 PLACE	± ---	± ---	ANGULAR ± 3°		DOCUMENT NO. SD-78127-001	
DRAFT WHERE APPLICABLE MUST REMAIN WITHIN DIMENSIONS		SEE TABLE		SHEET NO. 5 OF 7		

DRAWN BY YLQ1A0		DATE 2006/05/05	TITLE 0.50MM PITCH, FPC CONN. NON-ZIF, SMT	
CHECKED BY BOKOK		DATE 2006/06/06	APPROVED BY PTL IM	
DATE 2006/06/06		MATERIAL NO.		DOCUMENT NO. SD-78127-001
SIZE A3		THIS DRAWING CONTAINS INFORMATION THAT IS PROPRIETARY TO MOLEX INCORPORATED AND SHOULD NOT BE USED WITHOUT WRITTEN PERMISSION		SHEET NO. 5 OF 7

10 9 8 7 6 5 4 3 2 1

GOLD PLATING TERMINAL ASSEMBLY PART NUMBERS

ASSY P/N PACKED IN T&R	ASSY P/N W/O PACKAGING	CKT	W	So	F	Bo	B	EMBOSSED TYPE
78127-1068	78127-0068	6	24.00	-	11.50	5.40	3.10	A
78127-1078	78127-0078	7	24.00	-	11.50	5.90	3.60	
78127-1088	78127-0088	8	24.00	-	11.50	6.40	4.10	
78127-1098	78127-0098	9	24.00	-	11.50	6.90	4.60	
78127-1108	78127-0108	10	24.00	-	11.50	7.40	5.10	
78127-1118	78127-0118	11	24.00	-	11.50	7.90	5.60	
78127-1128	78127-0128	12	24.00	-	11.50	8.40	6.10	
78127-1138	78127-0138	13	24.00	-	11.50	8.90	6.60	
78127-1148	78127-0148	14	24.00	-	11.50	9.40	7.10	
78127-1158	78127-0158	15	24.00	-	11.50	9.90	7.60	
78127-1168	78127-0168	16	24.00	-	11.50	10.40	8.10	
78127-1178	78127-0178	17	24.00	-	11.50	10.90	8.60	
78127-1188	78127-0188	18	24.00	-	11.50	11.40	9.10	
78127-1198	78127-0198	19	24.00	-	11.50	11.90	9.60	
78127-1208	78127-0208	20	24.00	-	11.50	12.40	10.10	
78127-1218	78127-0218	21	32.00	28.40	14.20	12.90	10.60	B
78127-1228	78127-0228	22	32.00	28.40	14.20	13.40	11.10	
78127-1238	78127-0238	23	32.00	28.40	14.20	13.90	11.60	
78127-1248	78127-0248	24	32.00	28.40	14.20	14.40	12.10	
78127-1258	78127-0258	25	32.00	28.40	14.20	14.90	12.60	
78127-1268	78127-0268	26	32.00	28.40	14.20	15.40	13.10	
78127-1278	78127-0278	27	32.00	28.40	14.20	15.90	13.60	
78127-1288	78127-0288	28	32.00	28.40	14.20	16.40	14.10	
78127-1298	78127-0298	29	32.00	28.40	14.20	16.90	14.60	
78127-1308	78127-0308	30	32.00	28.40	14.20	17.40	15.10	

ASSY P/N PACKED IN T&R	ASSY P/N W/O PACKAGING	CKT	W	So	F	Bo	B	EMBOSSED TYPE
78127-1318	78127-0318	31	32.00	28.40	14.20	17.90	15.60	B
78127-1328	78127-0328	32	32.00	28.40	14.20	18.40	16.10	
78127-1338	78127-0338	33	32.00	28.40	14.20	18.90	16.60	
78127-1348	78127-0348	34	32.00	28.40	14.20	19.40	17.10	
78127-1358	78127-0358	35	32.00	28.40	14.20	19.90	17.60	
78127-1368	78127-0368	36	32.00	28.40	14.20	20.40	18.10	
78127-1378	78127-0378	37	32.00	28.40	14.20	20.90	18.60	
78127-1388	78127-0388	38	32.00	28.40	14.20	21.40	19.10	
78127-1398	78127-0398	39	44.00	40.40	20.20	21.90	19.60	
78127-1408	78127-0408	40	44.00	40.40	20.20	22.40	20.10	
78127-1418	78127-0418	41	44.00	40.40	20.20	22.90	20.60	
78127-1428	78127-0428	42	44.00	40.40	20.20	23.40	21.10	

REVISED EC NO: S2007-0721 DRWN: BOKOK CHKD: CGOH APPR: KCLING 2007/03/05 2007/03/05 2007/03/05	QUALITY SYMBOLS ▽=0 ▽=0	GENERAL TOLERANCES (UNLESS SPECIFIED)		DIMENSION STYLE MM ONLY		SCALE NTS	DESIGN UNITS METRIC	THIRD ANGLE PROJECTION			
		4 PLACES ± --- ± ---	3 PLACES ± --- ± ---	2 PLACES ± 0.15 ± ---	1 PLACE ± --- ± ---	DRAWN BY YLQ1A0	DATE 2006/05/05	TITLE 0.50MM PITCH, FPC CONN. NON-ZIF, SMT			
		ANGULAR ± 3 °				CHECKED BY BOKOK	DATE 2006/06/06	APPROVED BY PTL IM			
		DRAFT WHERE APPLICABLE MUST REMAIN WITHIN DIMENSIONS				MATERIAL NO. SEE TABLE	DATE 2006/06/06	MOLEX INCORPORATED		DOCUMENT NO. SD-78127-001	SHEET NO. 6 OF 7

9 8 7 6 5 4 3 2 1

10 9 8 7 6 5 4 3 2 1

TIN-BISMUTH PLATING TERMINAL ASSEMBLY PART NUMBERS

ASSY P/N PACKED IN T&R	ASSY P/N W/O PACKAGING	CKT	W	So	F	Bo	B	EMBOSSED TYPE	ASSY P/N PACKED IN T&R	ASSY P/N W/O PACKAGING	CKT	W	So	F	Bo	B	EMBOSSED TYPE		
78127-1069	78127-0069	6	24.00	-	11.50	5.40	3.10	A	78127-1319	78127-0319	31	32.00	28.40	14.20	17.90	15.60	B		
78127-1079	78127-0079	7	24.00	-	11.50	5.90	3.60		78127-1329	78127-0329	32	32.00	28.40	14.20	18.40	16.10			
78127-1089	78127-0089	8	24.00	-	11.50	6.40	4.10		78127-1339	78127-0339	33	32.00	28.40	14.20	18.90	16.60			
78127-1099	78127-0099	9	24.00	-	11.50	6.90	4.60		78127-1349	78127-0349	34	32.00	28.40	14.20	19.40	17.10			
78127-1109	78127-0109	10	24.00	-	11.50	7.40	5.10		78127-1359	78127-0359	35	32.00	28.40	14.20	19.90	17.60			
78127-1119	78127-0119	11	24.00	-	11.50	7.90	5.60		78127-1369	78127-0369	36	32.00	28.40	14.20	20.40	18.10			
78127-1129	78127-0129	12	24.00	-	11.50	8.40	6.10		78127-1379	78127-0379	37	32.00	28.40	14.20	20.90	18.60			
78127-1139	78127-0139	13	24.00	-	11.50	8.90	6.60		78127-1389	78127-0389	38	32.00	28.40	14.20	21.40	19.10			
78127-1149	78127-0149	14	24.00	-	11.50	9.40	7.10		78127-1399	78127-0399	39	44.00	40.40	20.20	21.90	19.60			
78127-1159	78127-0159	15	24.00	-	11.50	9.90	7.60		78127-1409	78127-0409	40	44.00	40.40	20.20	22.40	20.10			
78127-1169	78127-0169	16	24.00	-	11.50	10.40	8.10		78127-1419	78127-0419	41	44.00	40.40	20.20	22.90	20.60			
78127-1179	78127-0179	17	24.00	-	11.50	10.90	8.60		78127-1429	78127-0429	42	44.00	40.40	20.20	23.40	21.10			
78127-1189	78127-0189	18	24.00	-	11.50	11.40	9.10												
78127-1199	78127-0199	19	24.00	-	11.50	11.90	9.60												
78127-1209	78127-0209	20	24.00	-	11.50	12.40	10.10												
78127-1219	78127-0219	21	32.00	28.40	14.20	12.90	10.60												
78127-1229	78127-0229	22	32.00	28.40	14.20	13.40	11.10												
78127-1239	78127-0239	23	32.00	28.40	14.20	13.90	11.60												
78127-1249	78127-0249	24	32.00	28.40	14.20	14.40	12.10												
78127-1259	78127-0259	25	32.00	28.40	14.20	14.90	12.60												
78127-1269	78127-0269	26	32.00	28.40	14.20	15.40	13.10												
78127-1279	78127-0279	27	32.00	28.40	14.20	15.90	13.60												
78127-1289	78127-0289	28	32.00	28.40	14.20	16.40	14.10												
78127-1299	78127-0299	29	32.00	28.40	14.20	16.90	14.60												
78127-1309	78127-0309	30	32.00	28.40	14.20	17.40	15.10												

REVISED EC NO: S2007-0721 DRWN: BOKOK CHKD: CGOH APPR: KCLING 2007/03/05 2007/03/05 2007/03/05	QUALITY SYMBOLS ▽=0 ▽=0	GENERAL TOLERANCES (UNLESS SPECIFIED)		DIMENSION STYLE MM ONLY		SCALE NTS	DESIGN UNITS METRIC	THIRD ANGLE PROJECTION		
						DRAWN BY YLQ1A0		TITLE 0.50MM PITCH, FPC CONN. NON-ZIF, SMT		
						CHECKED BY BOKOK		DATE 2006/05/05		
						APPROVED BY PTL IM		DATE 2006/06/06		
		DRAFT WHERE APPLICABLE MUST REMAIN WITHIN DIMENSIONS		MATERIAL NO. SEE TABLE		DOCUMENT NO. SD-78127-001		SHEET NO. 7 OF 7		
A1				SIZE A3		THIS DRAWING CONTAINS INFORMATION THAT IS PROPRIETARY TO MOLEX INCORPORATED AND SHOULD NOT BE USED WITHOUT WRITTEN PERMISSION				

9 8 7 6 5 4 3 2 1