

PLEASE CHECK WWW.MOLEX.COM FOR LATEST PART INFORMATION

Part Number: **0473002100**
Status: **Active**
Overview: slimline serial ata odd connectors
Description: 1.00mm (.039"), 1.27mm (.050") Pitch Slimline Serial ATA Receptacle for Optical Disk Drive, Right Angle, Standard Type

Documents:

[3D Model](#) [Product Specification PS-47300-001 \(PDF\)](#)
[Drawing \(PDF\)](#) [RoHS Certificate of Compliance \(PDF\)](#)

Agency Certification

CSA LR 19980

General

Product Family PCB Receptacles
 Series [47300](#)
 Application Board-to-Board
 Comments Screw version
 Overview [slimline serial ata odd connectors](#)
 Product Name Serial ATA, Slimline Serial ATA

Physical

Circuits (Loaded) 13
 Circuits (maximum) 13
 Color - Resin Black
 Durability (mating cycles max) 500
 Flammability 94V-0
 Glow-Wire Compliant No
 Guide to Mating Part Yes
 Keying to Mating Part Yes
 Lock to Mating Part No
 Material - Metal Copper Alloy
 Material - Plating Mating Gold
 Material - Plating Termination Tin
 Material - Resin High Temperature Thermoplastic
 Number of Rows 1
 Orientation Right Angle
 PC Tail Length (in) 0.000 In
 PC Tail Length (mm) 0.00 mm
 PCB Locator Yes
 PCB Retention Yes
 PCB Thickness Recommended (in) 0.000 In
 PCB Thickness Recommended (mm) 0.00 mm
 Packaging Type Embossed Tape on Reel
 Pitch - Mating Interface (in) 0.039 In, 0.050 In
 Pitch - Mating Interface (mm) 1.00 mm, 1.27 mm
 Pitch - Term. Interface (in) 0.039 In, 0.050 In
 Pitch - Term. Interface (mm) 1.00 mm, 1.27 mm
 Plating min: Mating (µin) 15
 Plating min: Mating (µm) 0.38
 Plating min: Termination (µin) 40
 Plating min: Termination (µm) 1
 Polarized to Mating Part Yes
 Polarized to PCB Yes
 Stackable No
 Temperature Range - Operating -35°C to +85°C

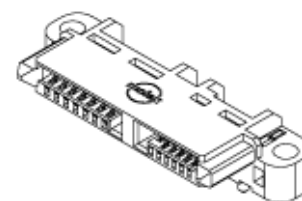

Series

image - Reference only

EU RoHS

**ELV and RoHS
 Compliant
 REACH SVHC
 Not Reviewed
 Halogen-Free
 Status
 Not Reviewed**

China RoHS



Need more information on product environmental compliance?

Email productcompliance@molex.com
 For a multiple part number RoHS Certificate of Compliance, [click here](#)

Please visit the [Contact Us](#) section for any non-product compliance questions.

Search Parts in this Series

[47300Series](#)

Mates With

[473001xxx Slimline Serial ATA Plugs](#)

Termination Interface: Style Surface Mount

Electrical

Current - Maximum per Contact 1.5A
Grounding to PCB Yes
Voltage - Maximum 15V DC

Material Info

Reference - Drawing Numbers

Product Specification PS-47300-001
Sales Drawing SD-47300-200

This document was generated on 05/26/2010

PLEASE CHECK WWW.MOLEX.COM FOR LATEST PART INFORMATION

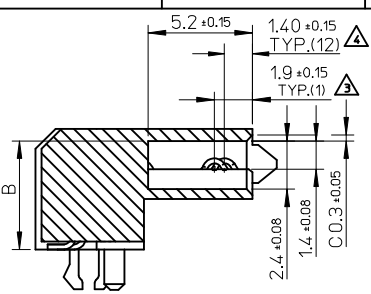
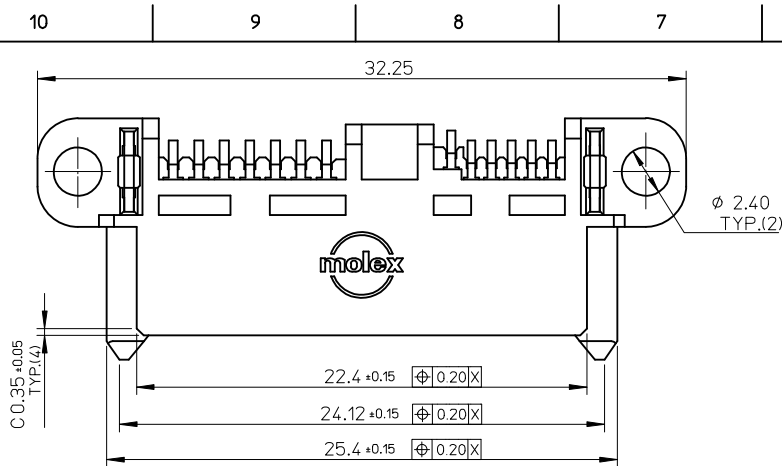

SECTION A-A

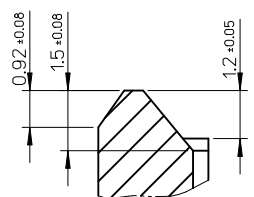

SECTION B-B
(8:1)

NOTES :

- 1.MATERIAL :
HOUSING : HIGH TEMPERATURE THERMOPLASTIC,
UL94V-0, 30% G.F., BLACK
TERMINAL : COPPER ALLOY
FORKLOCK : COPPER ALLOY
- 2.PLATING :
TERMINAL :
CONTACT AREA : GOLD PLATING, DETAIL REFER TO CHART.
SOLDER AREA : MATTE TIN PLATING 1 MICRONS MIN.
UNDERPLATING : NICKEL PLATING 2.5 MICRONS MIN.
FORKLOCK :
MATTE TIN PLATING 1 MICRONS MIN. OVER NICKEL PLATING
1 MICRONS MIN.
- 3.FOR P1 PIN ONLY.
4.FOR ALL OTHER PINS.
- 5.PRODUCT SPECIFICATION: PS-47300-001.
- 6.THE PRODUCT COMPLIANT TO RoHS DIRECTIVE 2002/95/EC
AND 2000/53/EC.

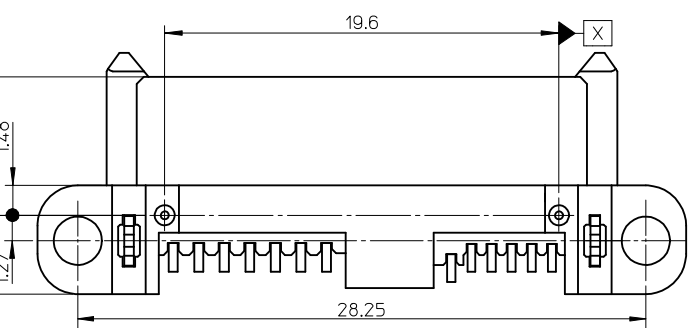
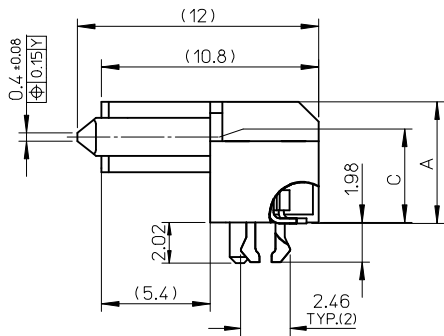
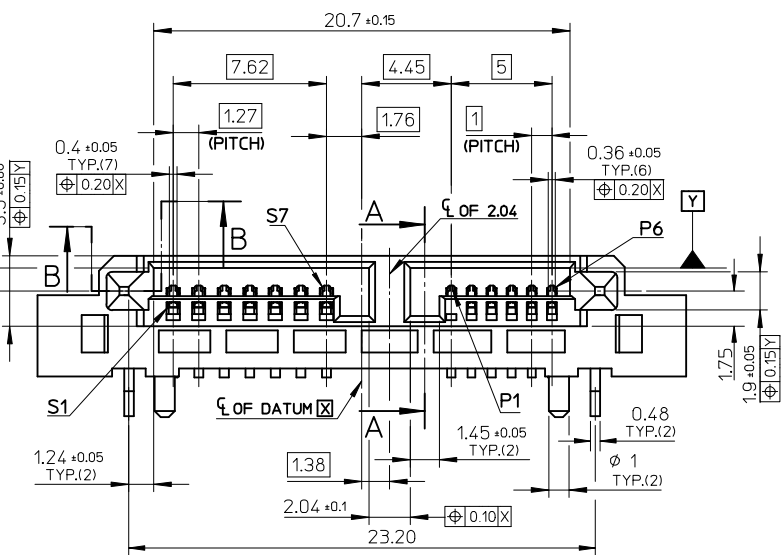
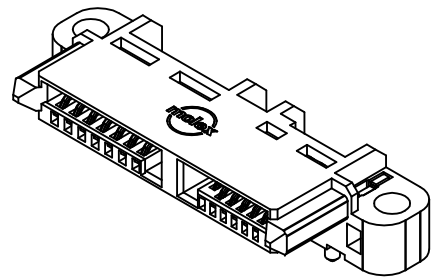

P/N	CONTACT PLATING SPEC	DIM'A'	DIM'B'	DIM'C'
47300-2000	GOLD FLASH	6	5.4	4.25
47300-2100	GOLD 15 u" MIN			
47300-2200	GOLD 30 u" MIN			

NO CHANGE	EC NO:	2009/07/28
DRWN:XOZHANG	2009/07/28	
CHKD:GLLI	2009/07/28	
APPR:XJ.SONG	2009/09/02	
REV	DESCRIPTION	

QUALITY SYMBOLS	GENERAL TOLERANCES (UNLESS SPECIFIED)	
	mm	INCH
▽=0	4 PLACES ± ---	± ---
▽=0	3 PLACES ± ---	± ---
	2 PLACES ± 0.15	± ---
	1 PLACE ± 0.20	± ---
	ANGULAR ± 3 °	
	DRAFT WHERE APPLICABLE MUST REMAIN WITHIN DIMENSIONS	

DIMENSION STYLE		SCALE	DESIGN UNITS	THIRD ANGLE PROJECTION
MM ONLY		4:1	METRIC	
DRAWN BY	DATE	TITLE		
DIXON LI	04/04/2006	SLIMLINE SATA RECEPTACLE CONNECTOR STANDARD TYPE		
CHECKED BY	DATE	MOLEX INCORPORATED		
JENNY ZENG	04/04/2006	DOCUMENT NO. SD-47300-200		
APPROVED BY	DATE	SHEET NO. 1 OF 3		
GRATE MA	04/04/2006			
MATERIAL NO.				
SIZE	THIS DRAWING CONTAINS INFORMATION THAT IS PROPRIETARY TO MOLEX INCORPORATED AND SHOULD NOT BE USED WITHOUT WRITTEN PERMISSION			
A3				

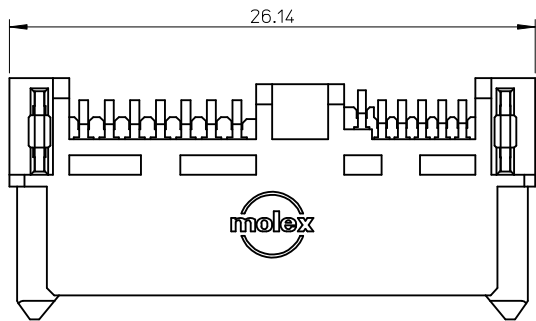

NOTES :
 TERMINAL CONTACT PLATING SPEC: GOLD FLASH,
 OTHER DIMENSIONS AND NOTES REFER TO SHEET-1

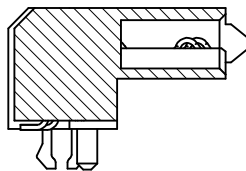

SECTION A1-A1

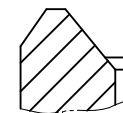
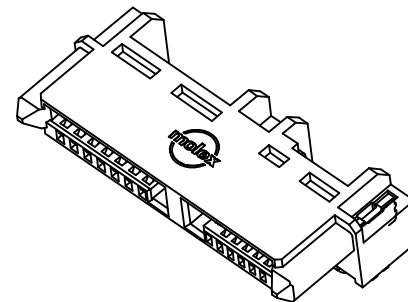
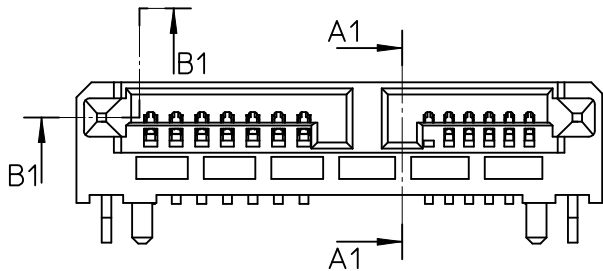

SECTION B1-B1
 (8:1)

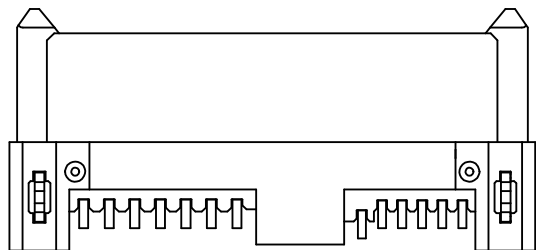

NO CHANGE EC NO: 2009/07/28 DRWN: XQZHANG 2009/07/28 CHKD: GLLI 2009/07/28 APPR: XJSONG 2009/09/02	DESCRIPTION REV	QUALITY SYMBOLS	GENERAL TOLERANCES (UNLESS SPECIFIED)	DIMENSION STYLE	SCALE	DESIGN UNITS	THIRD ANGLE PROJECTION	
		$\nabla=0$ $\text{C}=0$	mm INCH 4 PLACES ± --- ± --- 3 PLACES ± --- ± --- 2 PLACES ± 0.15 ± --- 1 PLACE ± 0.20 ± --- ANGULAR ± 3 °	MM ONLY	4:1	METRIC		
			DRAFT WHERE APPLICABLE MUST REMAIN WITHIN DIMENSIONS	DRAWN BY: DIXON LI DATE: 04/04/2006 CHECKED BY: JENNY ZENG DATE: 04/04/2006 APPROVED BY: GRATE MA DATE: 04/04/2006	TITLE	SLIMLINE SATA RECEPTACLE CONNECTOR SHORT TYPE		
				MATERIAL NO. 47300-2010 SIZE A3	MOLEX INCORPORATED DOCUMENT NO. SD-47300-200 SHEET NO. 2 OF 3	THIS DRAWING CONTAINS INFORMATION THAT IS PROPRIETARY TO MOLEX INCORPORATED AND SHOULD NOT BE USED WITHOUT WRITTEN PERMISSION		

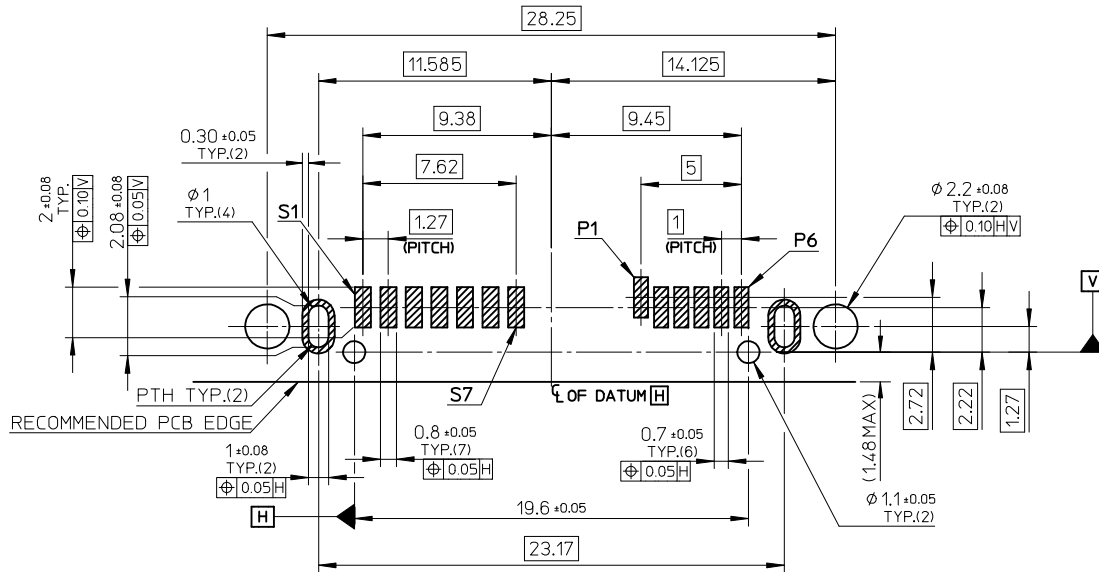

RECOMMENDED PCB LAYOUT
THICKNESS: 1.20±0.05

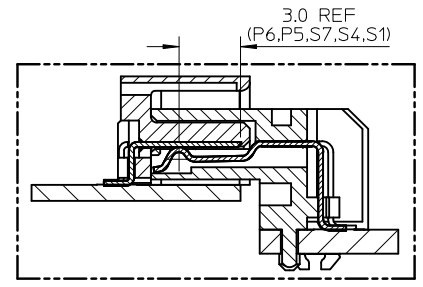

CUTAWAY1

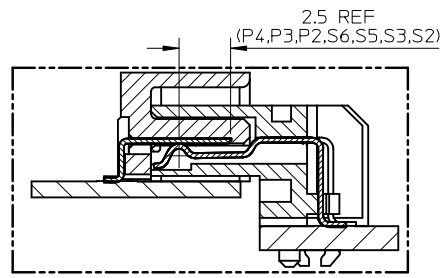

CUTAWAY2

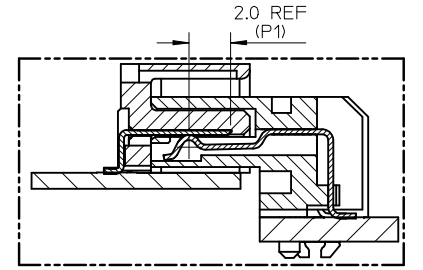

CUTAWAY3

ADD PCB THICKNESS IEC NO: 2009/07/28 DRW: XZHZHANG CH/KD: GLLI APPR: XJ.SONG 2009/09/02	QUALITY SYMBOLS 	GENERAL TOLERANCES (UNLESS SPECIFIED)		DIMENSION STYLE MM ONLY	SCALE 4:1	DESIGN UNITS METRIC	THIRD ANGLE PROJECTION		
		4 PLACES ± --- ± --- 3 PLACES ± --- ± --- 2 PLACES ± 0.15 ± --- 1 PLACE ± 0.20 ± ---	mm INCH ± --- ± --- ± 0.15 ± --- ± 0.20 ± ---	DRAWN BY: DIXON LI CHECKED BY: JENNY ZENG APPROVED BY: GRATE MA DATE: 04/04/2006	DATE: 04/04/2006 DATE: 04/04/2006 DATE: 04/04/2006	TITLE SLIMLINE SATA RECEPTACLE CONNECTOR			
		ANGULAR ± 3 °		MATERIAL NO. SEE REMARK		MOLEX INCORPORATED			SHEET NO. 3 OF 3
		DRAFT WHERE APPLICABLE MUST REMAIN WITHIN DIMENSIONS		SIZE A3		THIS DRAWING CONTAINS INFORMATION THAT IS PROPRIETARY TO MOLEX INCORPORATED AND SHOULD NOT BE USED WITHOUT WRITTEN PERMISSION			