

Ultralow Noise, Low Distortion, Audio Op Amp

FEATURES

- Voltage Noise: $1.2\text{nV}/\sqrt{\text{Hz}}$ Max at 1kHz
 $0.9\text{nV}/\sqrt{\text{Hz}}$ Typ at 1kHz
- Voltage and Current Noise 100% Tested
- Gain-Bandwidth Product: 40MHz Min
- Slew Rate: $10\text{V}/\mu\text{s}$ Min
- Voltage Gain: 2 Million Min
- Low THD at 10kHz, $A_V = -10$, $R_L = 600\Omega$: 0.002%
 $V_O = 7V_{\text{RMS}}$
- Low IMD, CCIF Method, $A_V = +10$: 0.002%
 $R_L = 600\Omega$
 $V_O = 7V_{\text{RMS}}$

DESCRIPTION

The LT[®]1115 is the lowest noise audio operational amplifier available. This ultralow noise performance ($0.9\text{nV}/\sqrt{\text{Hz}}$ at 1kHz) is combined with high slew rates ($>15\text{V}/\mu\text{s}$) and very low distortion specifications.

The RIAA circuit shown below using the LT1115 has very low distortion and little deviation from ideal RIAA response (see graph).

 LTC and LT are registered trademarks of Linear Technology Corporation.

APPLICATIONS

- High Quality Audio Preamplifiers
- Low Noise Microphone Preamplifiers
- Very Low Noise Instrumentation Amplifiers
- Low Noise Frequency Synthesizers
- Infrared Detector Amplifiers
- Hydrophone Amplifiers
- Low Distortion Oscillators

TYPICAL APPLICATION

RIAA Phonograph Preamplifier (40/60db Gain)

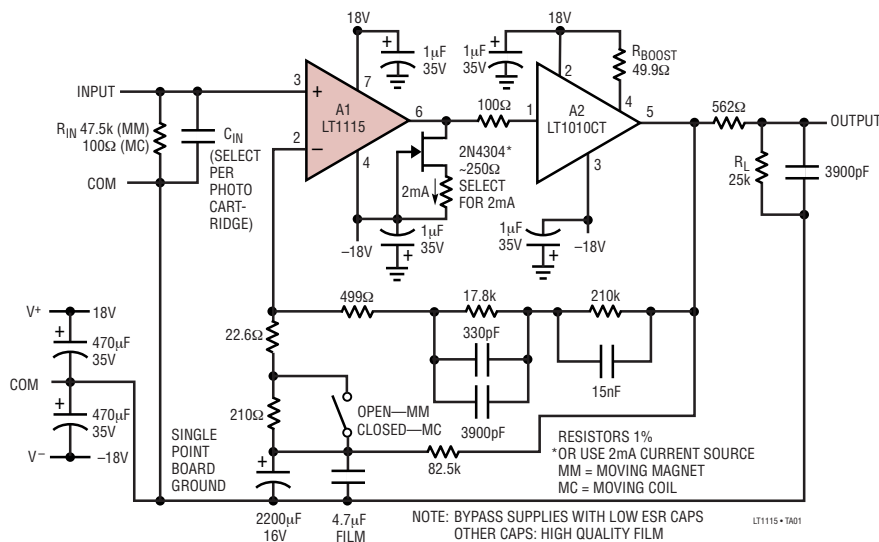

Measured Deviation from RIAA Response. Input at 1kHz = 1mV_{RMS} Pre-Emphasized

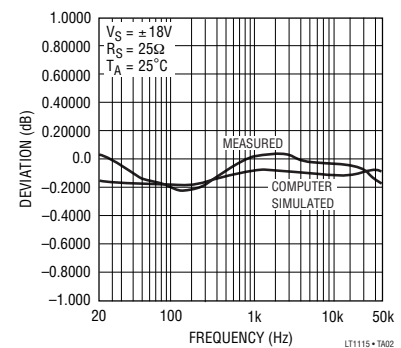

ABSOLUTE MAXIMUM RATINGS

(Note 1)

Supply Voltage $\pm 22\text{V}$
 Differential Input Current (Note 5) $\pm 25\text{mA}$
 Input Voltage Equal to Supply Voltage
 Output Short-Circuit Duration Indefinite

Operating Temperature Range 0°C to 70°C
 Storage Temperature Range -65°C to 150°C
 Lead Temperature (Soldering, 10 sec) 300°C

PACKAGE DESCRIPTION

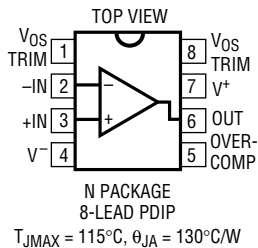
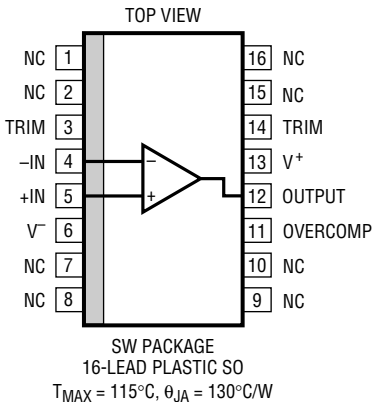
 <p>N PACKAGE 8-LEAD PDIP $T_{JMAX} = 115^\circ\text{C}$, $\theta_{JA} = 130^\circ\text{C/W}$</p>	ORDER PART NUMBER	 <p>SW PACKAGE 16-LEAD PLASTIC SO $T_{JMAX} = 115^\circ\text{C}$, $\theta_{JA} = 130^\circ\text{C/W}$</p>	ORDER PART NUMBER
	LT1115CN8		LT1115CSW

Consult LTC Marketing for parts specified with wider operating temperature ranges.

ELECTRICAL CHARACTERISTICS $V_S = \pm 18\text{V}$, $T_A = 25^\circ\text{C}$, unless otherwise noted.

SYMBOL	PARAMETER	CONDITIONS	MIN	TYP	MAX	UNITS
THD	Total Harmonic Distortion at 10kHz	$A_V = -10$, $V_O = 7V_{RMS}$, $R_L = 600$		< 0.002		%
IMD	Inter-Modulation Distortion (CCIF)	$A_V = 10$, $V_O = 7V_{RMS}$, $R_L = 600$		< 0.0002		%
V_{OS}	Input Offset Voltage	(Note 2)		50	200	μV
I_{OS}	Input Offset Current	$V_{CM} = 0\text{V}$		30	200	nA
I_B	Input Bias Current	$V_{CM} = 0\text{V}$		± 50	± 380	nA
e_n	Input Noise Voltage Density	$f_o = 10\text{Hz}$		1.0		$\text{nV}/\sqrt{\text{Hz}}$
		$f_o = 1000\text{Hz}$, 100% tested		0.9	1.2	$\text{nV}/\sqrt{\text{Hz}}$
	Wideband Noise	DC to 20kHz		120		nV_{RMS}
	Corresponding Voltage Level re 0.775V			-136		dB
i_n	Input Noise Current Density (Note 3)	$f_o = 10\text{Hz}$		4.7		$\text{pA}/\sqrt{\text{Hz}}$
		$f_o = 1000\text{Hz}$, 100% tested		1.2	2.2	$\text{pA}/\sqrt{\text{Hz}}$
	Input Resistance			250		$\text{M}\Omega$
	Common Mode			15		$\text{k}\Omega$
	Differential Mode					
	Input Capacitance			5		pF
	Input Voltage Range		± 13.5	± 15.0		V

ELECTRICAL CHARACTERISTICS $V_S = \pm 18V$, $T_A = 25^\circ C$, unless otherwise noted.

SYMBOL	PARAMETER	CONDITIONS	MIN	TYP	MAX	UNITS
CMRR	Common Mode Rejection Ratio	$V_{CM} = \pm 13.5V$	104	123		dB
PSRR	Power Supply Rejection Ratio	$V_S = \pm 4V$ to $\pm 19V$	104	126		dB
A_{VOL}	Large-Signal Voltage Gain	$R_L \geq 2k\Omega$, $V_O = \pm 14.5V$	2.0	20		V/ μV
		$R_L \geq 1k\Omega$, $V_O = \pm 13V$	1.5	15		V/ μV
		$R_L \geq 600\Omega$, $V_O = \pm 10V$	1.0	10		V/ μV
V_{OUT}	Maximum Output Voltage Swing	No Load	± 15.5	± 16.5		V
		$R_L \geq 2k\Omega$	± 14.5	± 15.5		V
		$R_L \geq 600\Omega$	± 11.0	± 14.5		V
SR	Slew Rate	$A_{VCL} = -1$	10	15		V/ μs
GBW	Gain-Bandwidth Product	$f_0 = 20kHz$ (Note 4)	40	70		MHz
Z_0	Open Loop Output Impedance	$V_O = 0$, $I_O = 0$		70		Ω
I_S	Supply Current			8.5	11.5	mA

The ● denotes specifications which apply over the full operating temperature range, otherwise specifications are at $T_A = 25^\circ C$. $V_S = \pm 18V$, unless otherwise noted.

SYMBOL	PARAMETER	CONDITIONS		MIN	TYP	MAX	UNITS
V_{OS}	Input Offset Voltage	(Note 2)	●		75	280	μV
$\Delta V_{OS}/\Delta T$	Average Input Offset Drift				0.5		$\mu V/^\circ C$
I_{OS}	Input Offset Current	$V_{CM} = 0V$	●		40	300	nA
I_B	Input Bias Current	$V_{CM} = 0V$	●		± 70	± 550	nA
	Input Voltage Range		●	± 13	± 14.8		V
CMRR	Common Mode Rejection Ratio	$V_{CM} = \pm 13V$	●	100	120		dB
PSRR	Power Supply Rejection Ratio	$V_S = \pm 4.5V$ to $\pm 18V$	●	100	123		dB
A_{VOL}	Large-Signal Voltage Gain	$R_L \geq 2k\Omega$, $V_O = \pm 13V$	●	1.5	15		V/ μV
		$R_L \geq 1k\Omega$, $V_O = \pm 11V$		1.0	10		V/ μV
V_{OUT}	Maximum Output Voltage Swing	No Load		± 15	± 16.3		V
		$R_L \geq 2k\Omega$	●	± 13.8	± 15.3		V
		$R_L \geq 600\Omega$		± 10	± 14.3		V
I_S	Supply Current		●		9.3	13	mA

Note 1: Absolute Maximum Ratings are those values beyond which the life of a device may be impaired.

Note 2: Input Offset Voltage measurements are performed by automatic test equipment approximately 0.5 sec after application of power.

Note 3: Current noise is defined and measured with balanced source resistors. The resultant voltage noise (after subtracting the resistor noise on an RMS basis) is divided by the sum of the two source resistors to obtain current noise.

Note 4: Gain-bandwidth product is not tested. It is guaranteed by design and by inference from the slew rate measurement.

Note 5: The inputs are protected by back-to-back diodes. Current limiting resistors are not used in order to achieve low noise. If differential input voltage exceeds $\pm 1.8V$, the input current should be limited to 25mA.

TYPICAL PERFORMANCE CHARACTERISTICS

Wideband Noise, DC to 20kHz

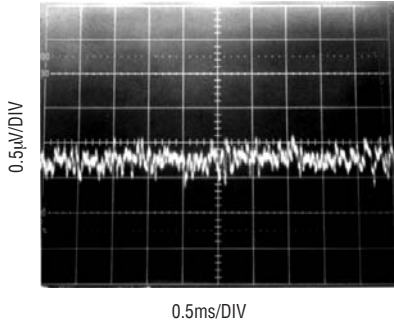

Wideband Voltage Noise
(0.1Hz to Frequency Indicated)

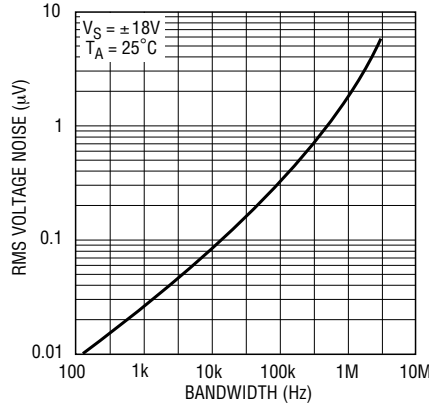

Total Noise vs Matched Source Resistance

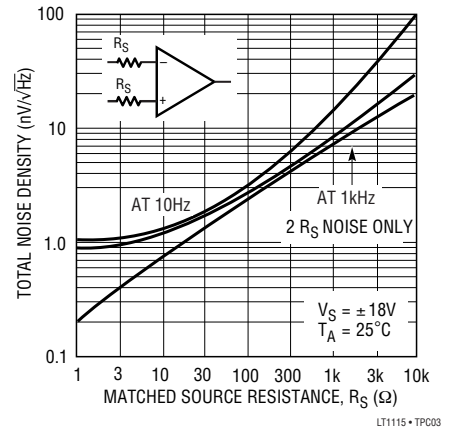

THD + Noise vs Frequency
($A_V = -10$)

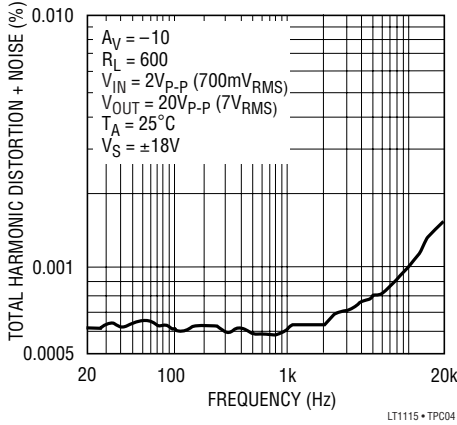

THD + Noise vs Frequency
($A_V = -100$)

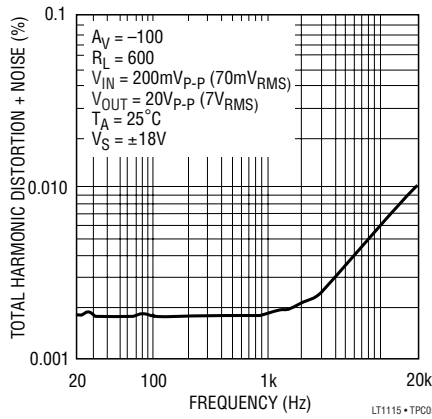

THD + Noise vs Frequency
($A_V = -1000$)

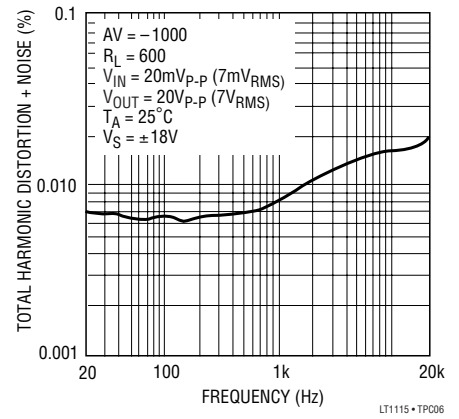

THD + Noise vs Frequency
($A_V = 10$)

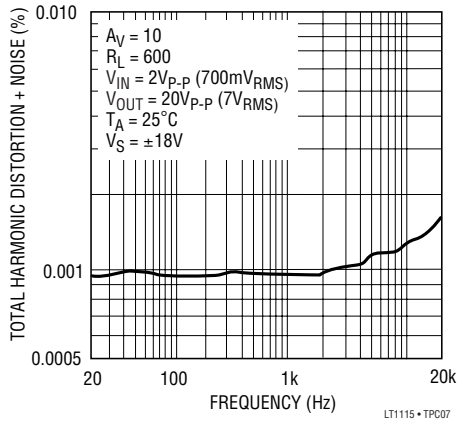

THD + Noise vs Frequency
($A_V = 100$)

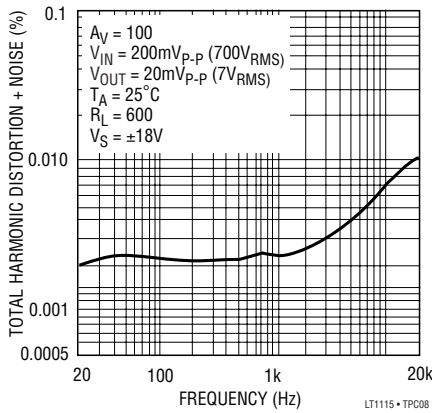

THD + Noise vs Frequency
($A_V = 1000$)

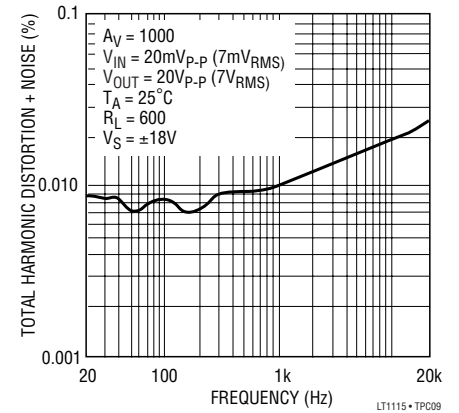

TYPICAL PERFORMANCE CHARACTERISTICS

CCIF IMD Test (Twin Equal Amplitude Tones at 13 and 14kHz)*

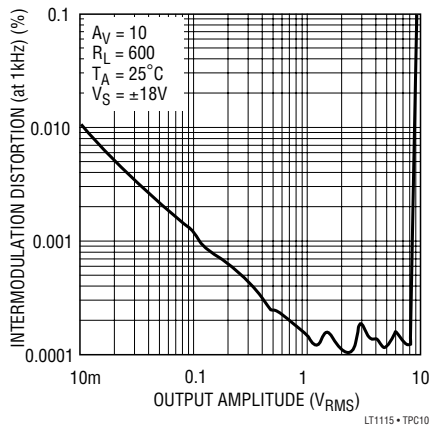

CCIF IMD Test (Twin Equal Amplitude Tones at 13 and 14kHz)*

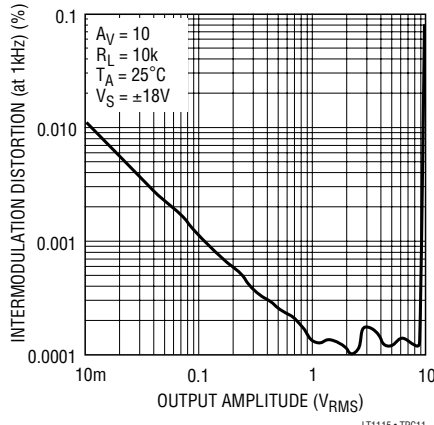

Slew Rate, Gain-Bandwidth-Product vs Overcompensation Capacitor

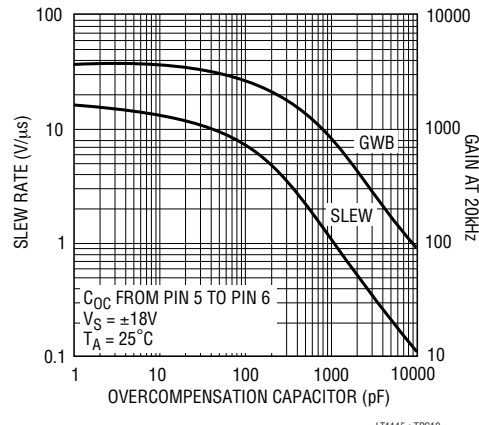

Total Noise vs Unmatched Source Resistance

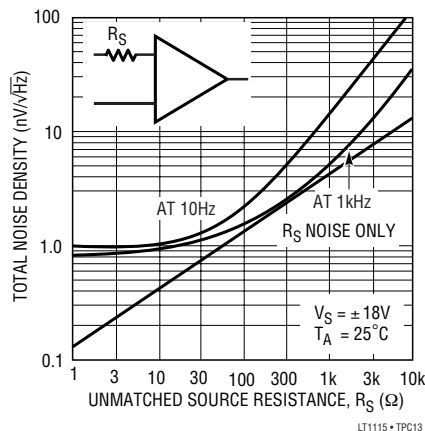

Current Noise Spectrum

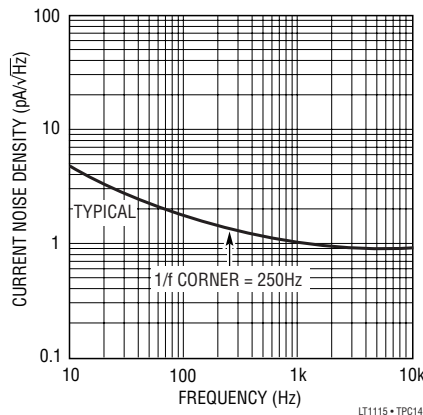

Voltage Noise vs Temperature

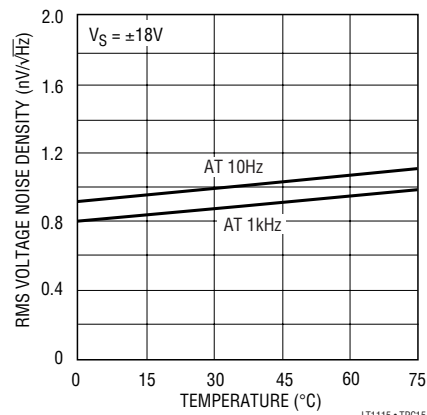

Voltage Noise vs Supply Voltage

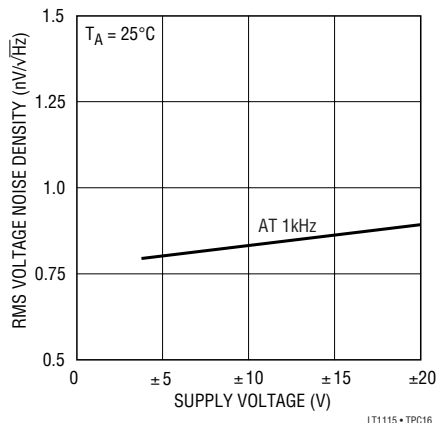

Supply Current vs Temperature

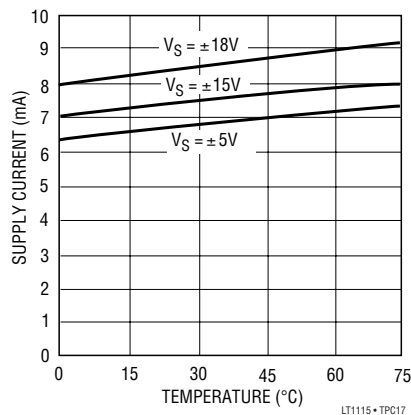

Output Short-Circuit Current vs Time

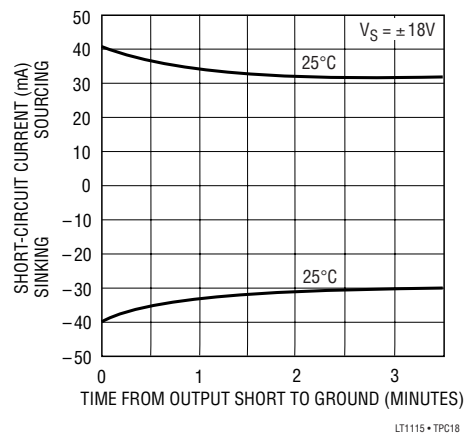

*See CCIF Test Note at end of "Typical Performance Characteristics".

TYPICAL PERFORMANCE CHARACTERISTICS

Voltage Gain vs Frequency

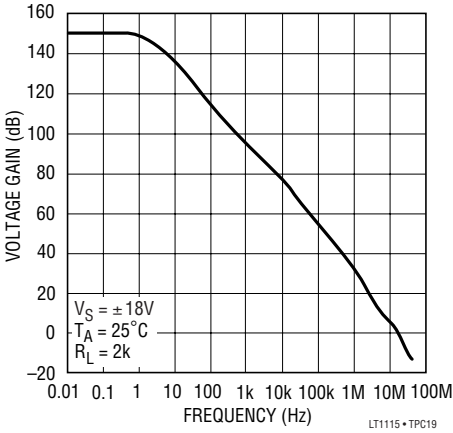

Gain, Phase vs Frequency

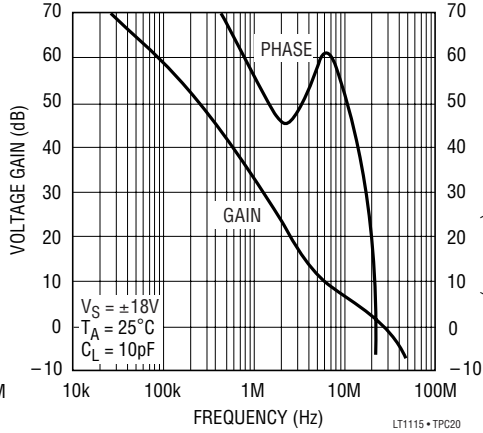

Voltage Gain vs Supply Voltage

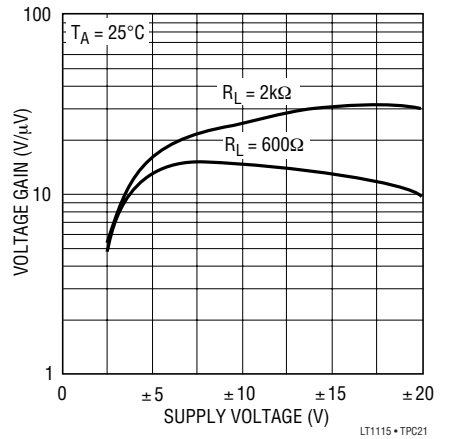

Voltage Gain vs Load Resistance

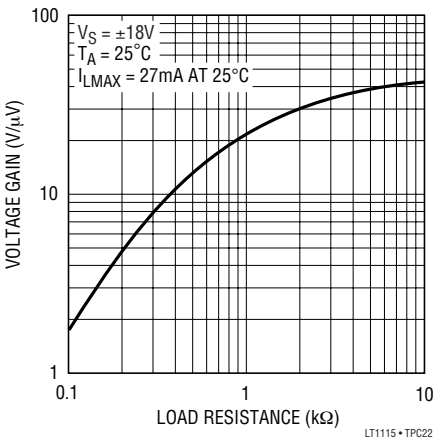

Capacitance Load Handling

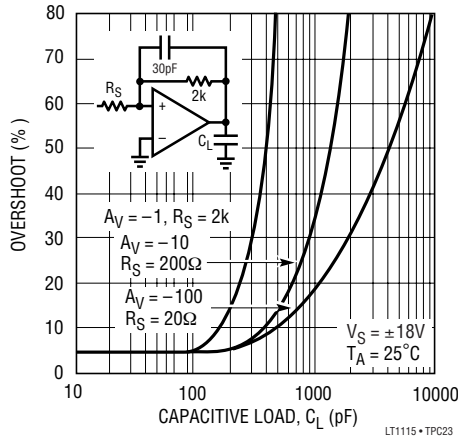

Common Mode Limit Over Temperature

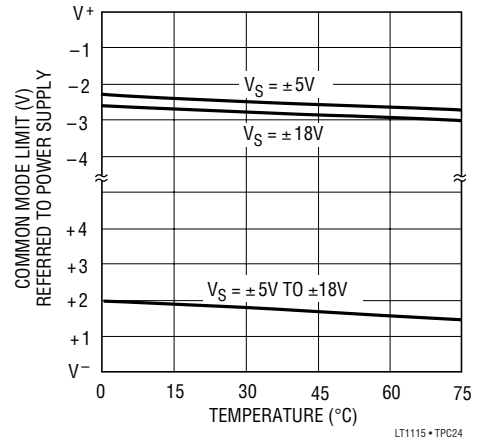

Common Mode Rejection Ratio vs Frequency

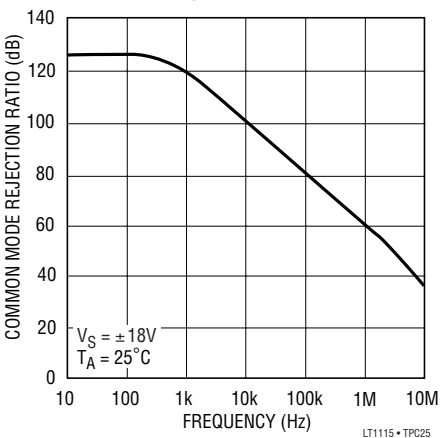

Power Supply Rejection Ratio vs Frequency

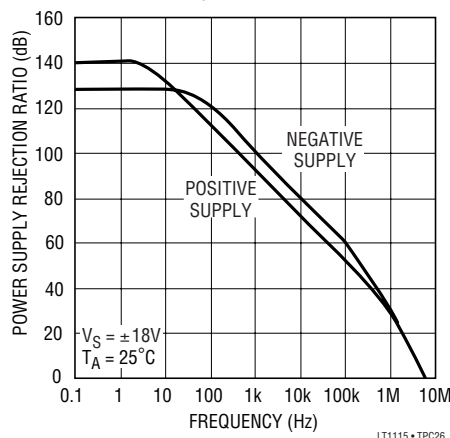

Large-Signal Transient Response

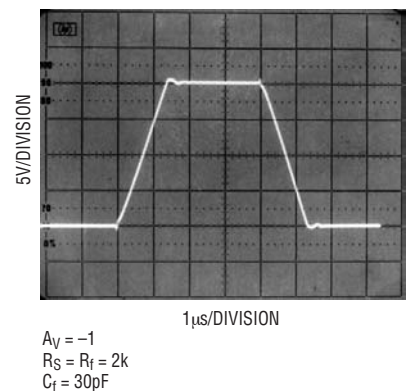

TYPICAL PERFORMANCE CHARACTERISTICS

Small-Signal Transient Response

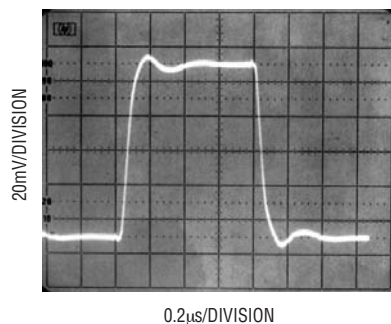

$A_V = -1$,
 $R_S = R_f = 2k\Omega$
 $C_f = 30pF$
 $C_L = 80pF$

Maximum Output vs Frequency
 (Power Bandwidth*)

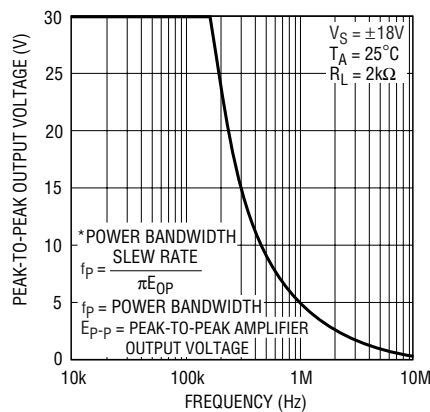

LT1115 • TPC29

Closed-Loop Output Impedance

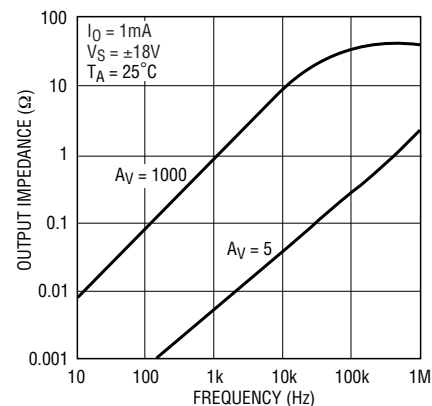

LT1115 • TPC30

CCIF Testing

Note: The CCIF twin-tone intermodulation test inputs two closely spaced equal amplitude tones to the device under test (DUT). The analyzer then measures the intermodulation distortion (IMD) produced in the DUT by measuring the difference tone equal to the spacing between the tones.

The amplitude of the IMD test input is in sinewave peak equivalent terms. As an example, selecting an amplitude of 1.000V will result in the complex IMD signal having the same 2.828V peak-to-peak amplitude that a 1.000V sinewave has. Clipping in a DUT will thus occur at the same input amplitude for THD + N and IMD modes.

APPLICATIONS INFORMATION

The LT1115 is a very high performance op amp, but not necessarily one which is optimized for universal application. Because of very low voltage noise and the resulting high gain-bandwidth product, the device is most applicable to relatively high gain applications. Thus, while the LT1115 will provide notably superior performance to the 5534 in most applications, the device may require circuit modifications to be used at very low noise gains. The part is not generally applicable for unity gain followers or inverters. In general, it should always be used with good low impedance bypass capacitors on the supplies, low impedance feedback values, and minimal capacitive loading. Ground plane construction is recommended, as is a compact layout.

Voltage Noise vs Current Noise

The LT1115's less than $1nV/\sqrt{Hz}$ voltage noise matches that of the LT1028 and is three times better than the lowest voltage noise heretofore available (on the LT1007/1037). A necessary condition for such low voltage noise is operating the input transistors at nearly 1mA of collector currents, because voltage noise is inversely proportional to the square root of the collector current. Current noise, however, is directly proportional to the square root of the collector current. Consequently, the LT1115's current noise is significantly higher than on most monolithic op amps.

APPLICATIONS INFORMATION

Therefore, to realize truly low noise performance it is important to understand the interaction between voltage noise (e_n), current noise (i_n) and resistor noise (r_n).

Total Noise vs Source Resistance

The total input referred noise of an op amp is given by

$$e_t = [e_n^2 + r_n^2 + (i_n R_{eq})^2]^{1/2}$$

where R_{eq} is the total equivalent source resistance at the two inputs

and $r_n = \sqrt{4kTR_{eq}} = 0.13\sqrt{R_{eq}}$ in nV/\sqrt{Hz} at $25^\circ C$

As a numerical example, consider the total noise at 1kHz of the gain of 1000 amplifier shown below.

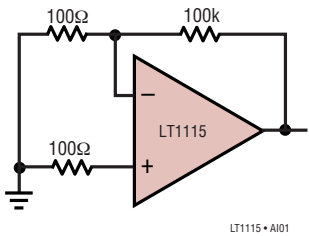

$$R_{eq} = 100\Omega + 100\Omega || 100k \approx 200\Omega$$

$$r_n = 0.13\sqrt{200} = 1.84nV/\sqrt{Hz}$$

$$e_n = 0.85nV/\sqrt{Hz}$$

$$i_n = 1.0pA/\sqrt{Hz}$$

$$e_t = [0.85^2 + 1.84^2 + (1.0 \times 2.0)^2]^{1/2} = 2.04nV/\sqrt{Hz}$$

$$\text{output noise} = 1000 e_t = 2.04\mu V/\sqrt{Hz}$$

At very low source resistance ($R_{eq} < 40\Omega$) voltage noise dominates. As R_{eq} is increased resistor noise becomes the largest term—as in the example above—and the LT1115's voltage noise becomes negligible. As R_{eq} is further increased, current noise becomes important. At 1kHz, when R_{eq} is in excess of $20k\Omega$, the current noise component is larger than the resistor noise. The Total Noise vs Matched Source Resistance plot in the Typical Performance Characteristics section, illustrates the above calculations.

The plot also shows that current noise is more dominant at low frequencies, such as 10Hz. This is because resistor noise is flat with frequency, while the $1/f$ corner of current noise is typically at 250Hz. At 10Hz when $R_{eq} > 1k\Omega$, the current noise term will exceed the resistor noise.

When the source resistance is unmatched, the Total Noise vs Unmatched Source Resistance plot should be consulted. Note that total noise is lower at source resistances below $1k\Omega$ because the resistor noise contribution is less. When $R_S > 1k\Omega$ total noise is not improved, however. This is because bias current cancellation is used to reduce input bias current. The cancellation circuitry injects two correlated current noise components into the two inputs. With matched source resistors the injected current noise creates a common-mode voltage noise and gets rejected by the amplifier. With source resistance in one input only, the cancellation noise is added to the amplifier's inherent noise.

In summary, the LT1115 is the optimum amplifier for noise performance—provided that the source resistance is kept low. The following table depicts which op amp manufactured by Linear Technology should be used to minimize noise—as the source resistance is increased beyond the LT1115's level of usefulness.

Best Op Amp for Lowest Total Noise vs Source Resistance

SOURCE RESISTANCE (NOTE 1)	BEST OP AMP	
	AT LOW FREQ (10Hz)	WIDEBAND (1kHz)
0 to 400Ω	LT1028/1115	LT1028/1115
400Ω to 4kΩ	LT1007/1037	LT1028/1115
4kΩ to 40kΩ	LT1001*	LT1007/1037
40kΩ to 500kΩ	LT1012*	LT1001*
500kΩ to 5MΩ	LT1012* or LT1055	LT1012*
> 5M	LT1055	LT1055

Note 1: Source resistance is defined as matched or unmatched, e.g., $R_S = 1k\Omega$ means: $1k\Omega$ at each input, or $1k\Omega$ at one input and zero at the other.

* These op amps are best utilized in applications requiring less bandwidth than audio.

TYPICAL APPLICATIONS

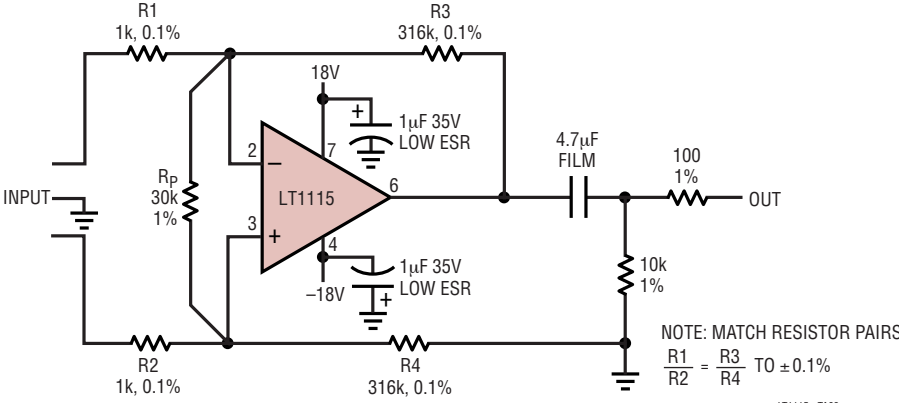
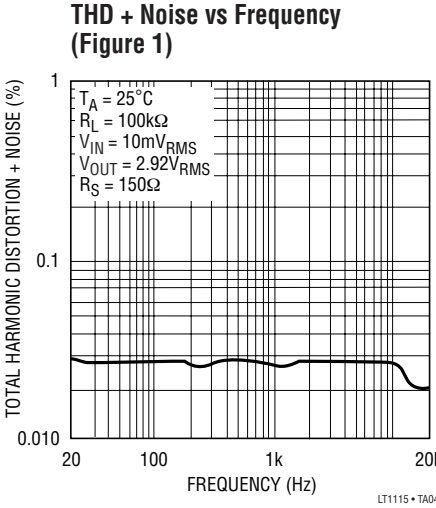

Figure 1. Balanced Transformerless Microphone Preamp



TYPICAL APPLICATIONS

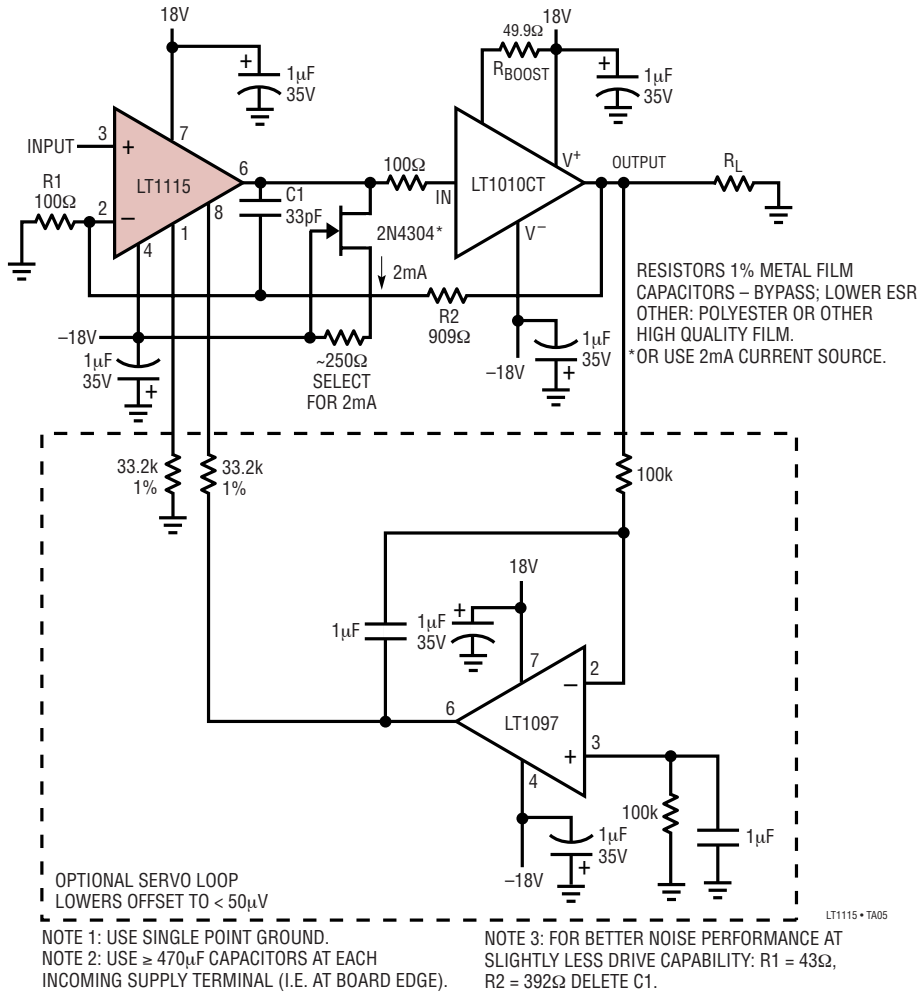
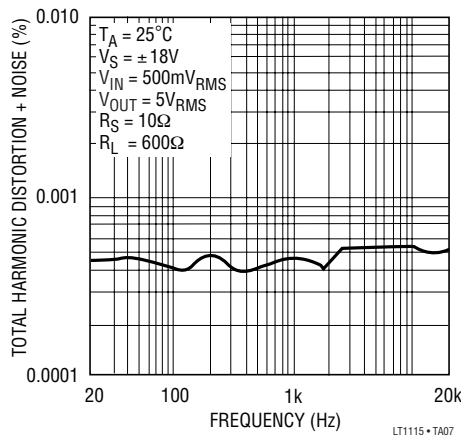

Figure 2. Low Noise DC Accurate x 10 Buffered Line Amplifier

THD + Noise vs Frequency
(Figure 2)



TYPICAL APPLICATIONS

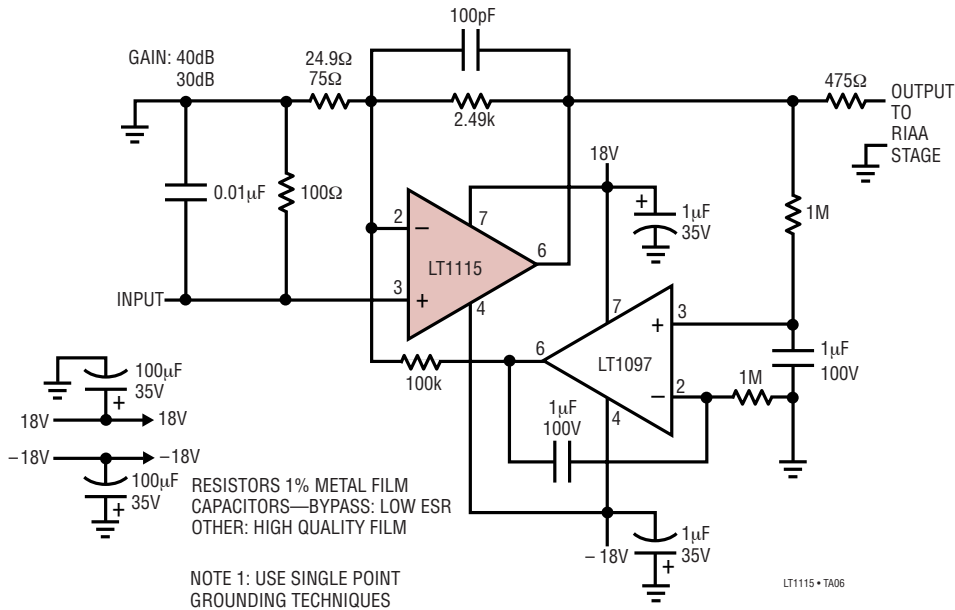
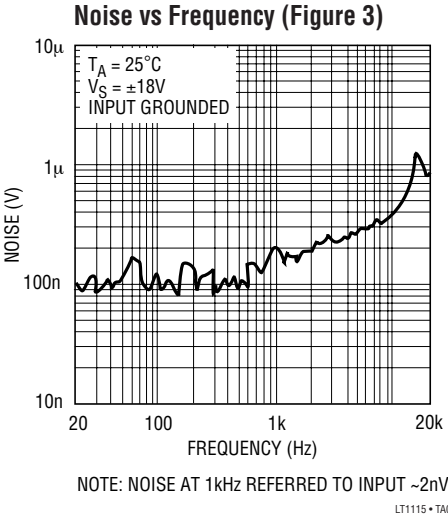
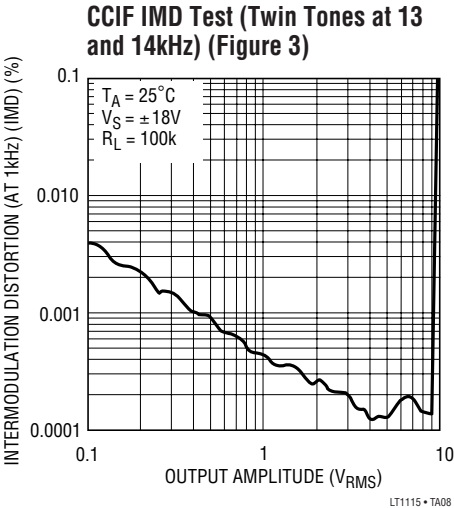

Figure 3. RIAA Moving Coil "Pre-Pre" Amplifier (40/30dB Gain Low Noise Servo'd Amplifier)



TYPICAL APPLICATIONS

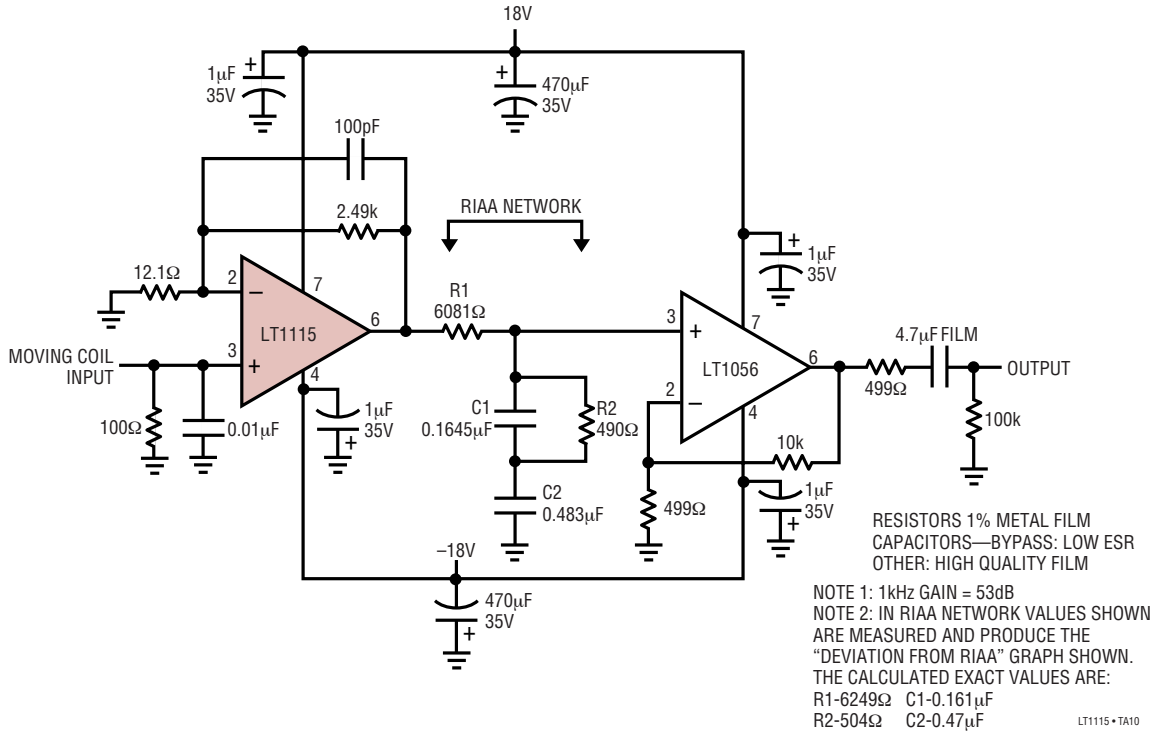
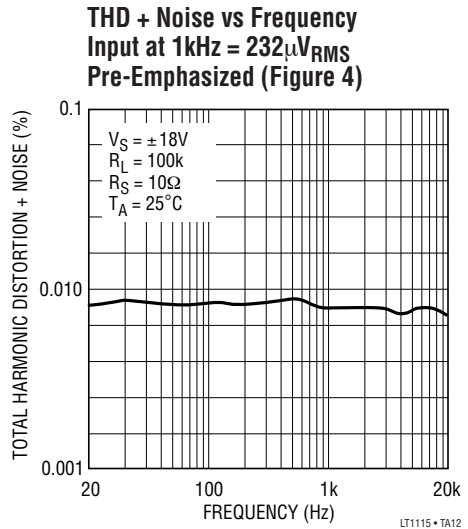
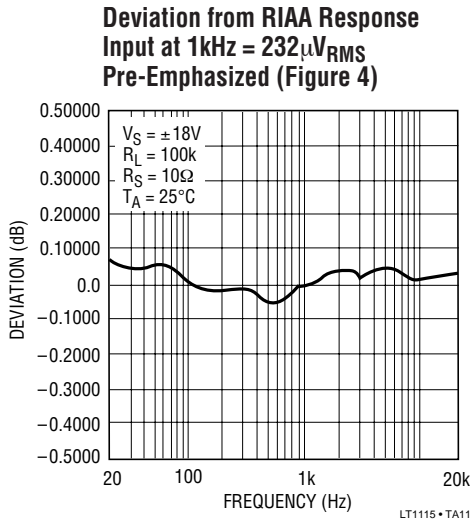

Figure 4. Moving Coil Passive RIAA Phonograph Pre-Amp



TYPICAL APPLICATIONS

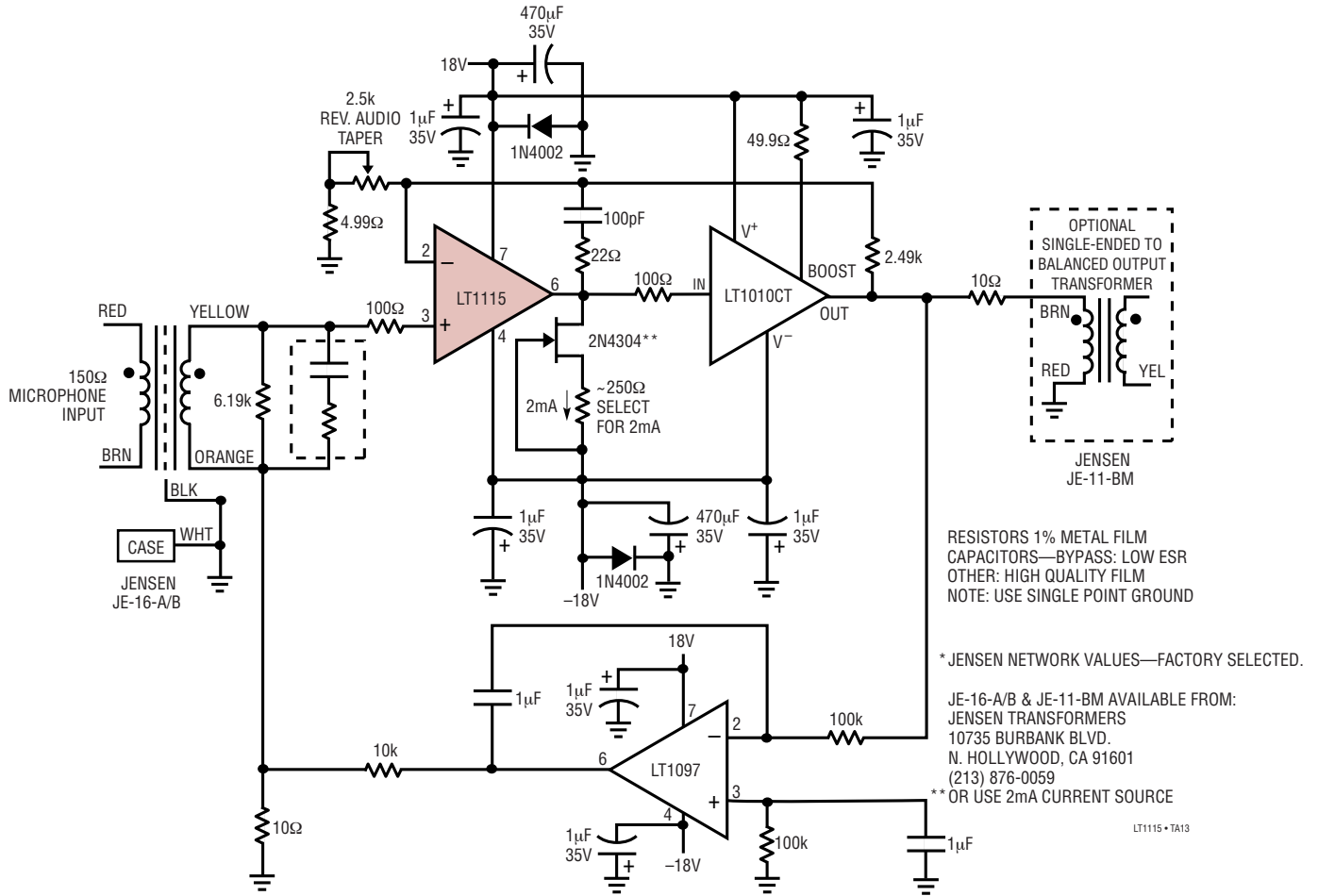
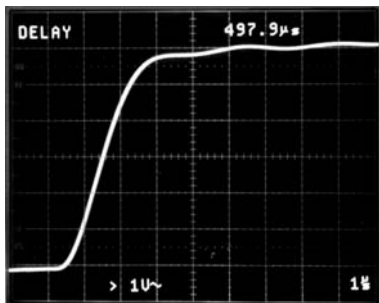

Figure 5. High Performance Transformer Coupled Microphone Pre-Amp

Risetime of High Performance Transformer Coupled Microphone Pre-Amp (Figure 5)



RISE TIME OF PRE-AMP
 $A_V = 20\text{dB}$
 $V_{IN} = 400\text{mV}$
2kHz SQUARE WAVE MEASURED AT SINGLE-ENDED OUTPUT BEFORE TRANSFORMER

THD + Noise vs Frequency (Gain = 20dB) Balanced In/ Balanced Out (Figure 5)

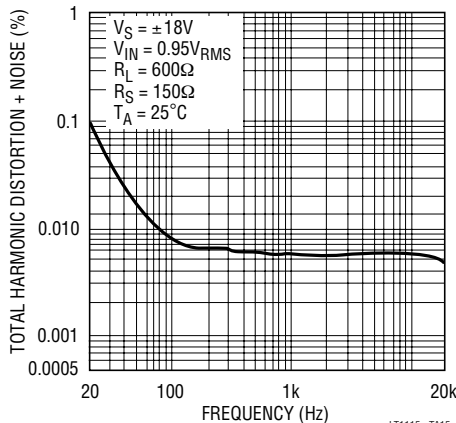

Frequency Response (Gain = 20dB) Balanced In/ Balanced Out (Figure 5)

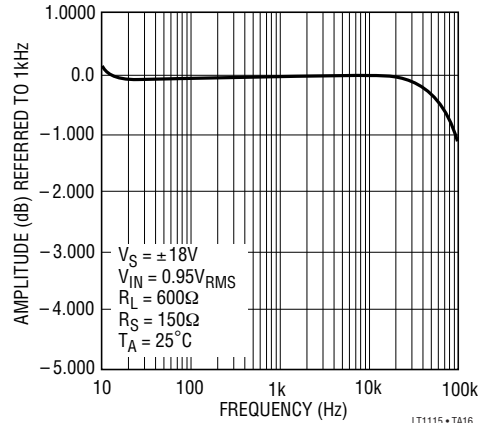

TYPICAL APPLICATIONS

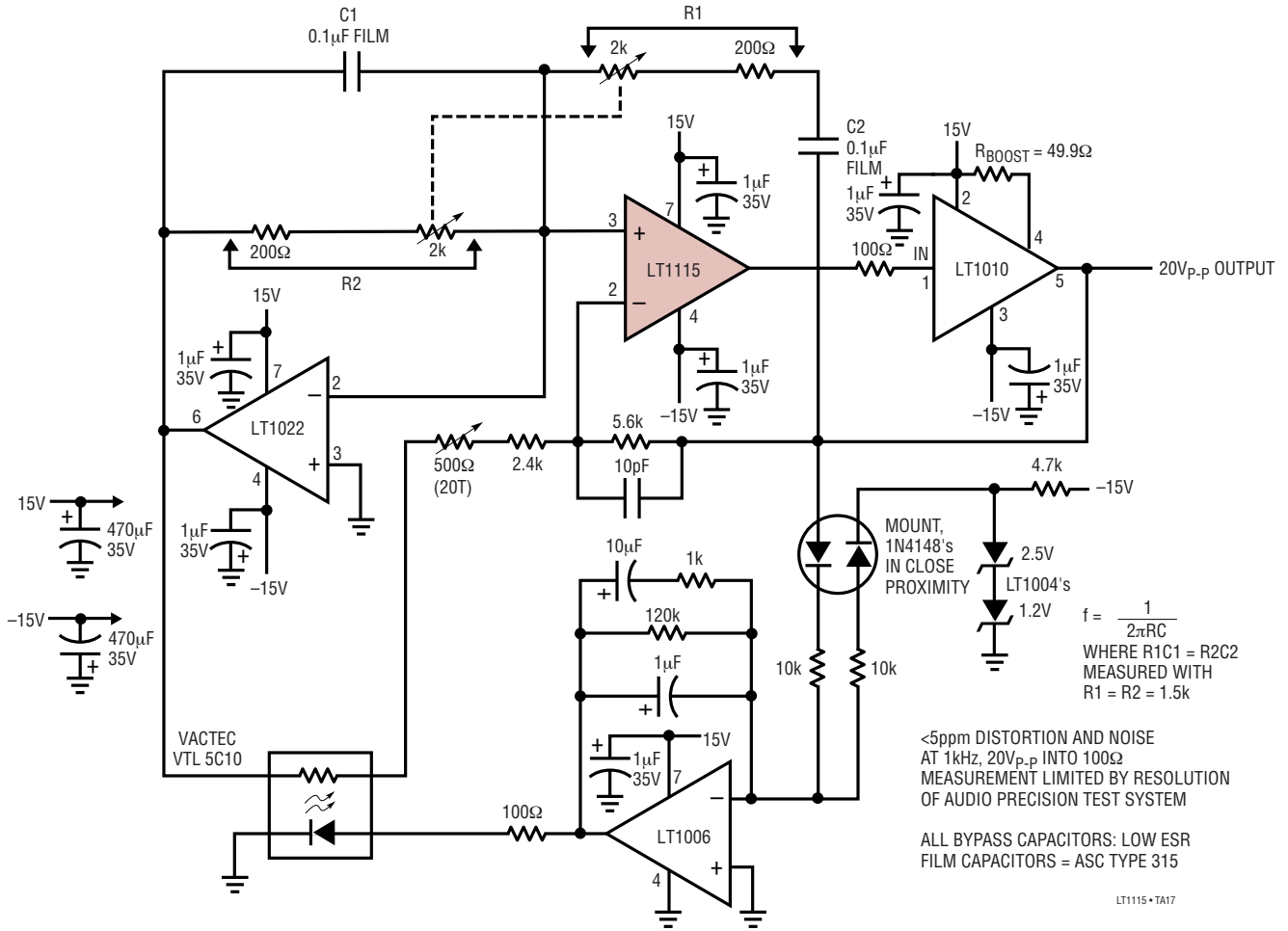
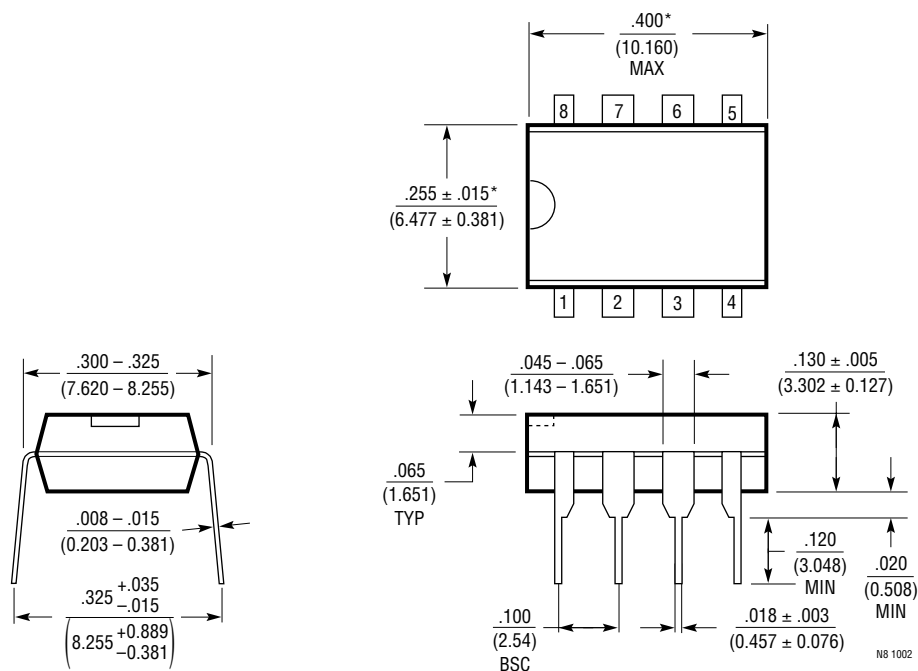

Figure 6. Ultralow THD Oscillator (Sine Wave) (< 5ppm Distortion)

PACKAGE DESCRIPTION

N8 Package 8-Lead PDIP (Narrow .300 Inch) (Reference LTC DWG # 05-08-1510)



NOTE:
1. DIMENSIONS ARE $\frac{\text{INCHES}}{\text{MILLIMETERS}}$
*THESE DIMENSIONS DO NOT INCLUDE MOLD FLASH OR PROTRUSIONS.
MOLD FLASH OR PROTRUSIONS SHALL NOT EXCEED .010 INCH (0.254mm)

PACKAGE DESCRIPTION

SW Package
16-Lead Plastic Small Outline (Wide .300 Inch)
 (Reference LTC DWG # 05-08-1620)

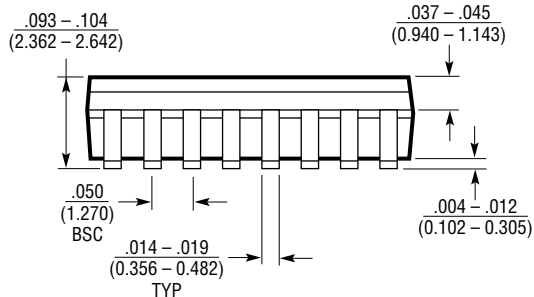
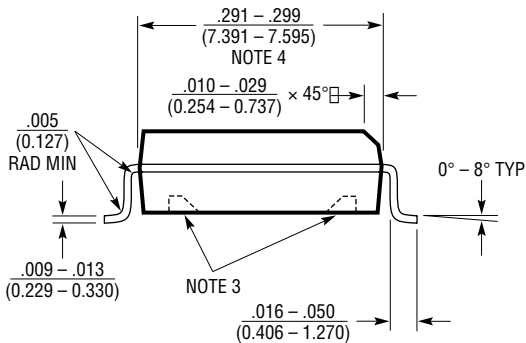
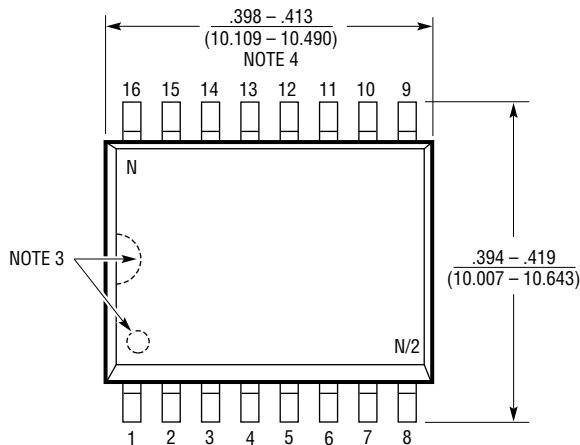
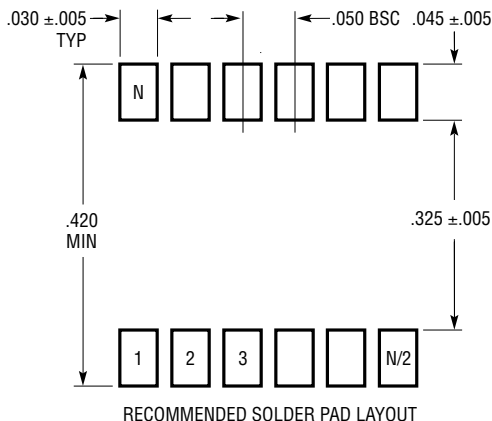

- NOTE:
1. DIMENSIONS IN $\frac{\text{INCHES}}{\text{MILLIMETERS}}$
 2. DRAWING NOT TO SCALE
 3. PIN 1 IDENT, NOTCH ON TOP AND CAVITIES ON THE BOTTOM OF PACKAGES ARE THE MANUFACTURING OPTIONS. THE PART MAY BE SUPPLIED WITH OR WITHOUT ANY OF THE OPTIONS
 4. THESE DIMENSIONS DO NOT INCLUDE MOLD FLASH OR PROTRUSIONS. MOLD FLASH OR PROTRUSIONS SHALL NOT EXCEED .006" (0.15mm)

S16 (WIDE) 0502