

PLEASE CHECK WWW.MOLEX.COM FOR LATEST PART INFORMATION

Part Number: [0350230002](#)
Status: **Active**
Description: 2.00mm (.079") Pitch Board-In Crimp Housing, 2 Circuits

Documents:

[3D Model](#) [Product Specification PS-35044-001 \(PDF\)](#)
[Drawing \(PDF\)](#) [RoHS Certificate of Compliance \(PDF\)](#)
[Product Specification PS-35023-001 \(PDF\)](#)

Agency Certification

CSA LR19980
 UL E29179

General

Product Family Crimp Housings
 Series [35023](#)
 Product Name Board-In

Physical

Circuits (maximum) 2
 Color - Resin Natural
 Flammability 94V-0
 Gender Female
 Glow-Wire Compliant No
 Material - Resin Nylon
 Number of Rows 1
 Packaging Type Bag
 Panel Mount No
 Pitch - Mating Interface (in) 0.079 In
 Pitch - Mating Interface (mm) 2.00 mm
 Stackable No
 Temperature Range - Operating -40°C to +105°C

Material Info

Reference - Drawing Numbers

Product Specification PS-35023-001, PS-35044-001
 Sales Drawing SD-35023-*0**, SD-35023-001

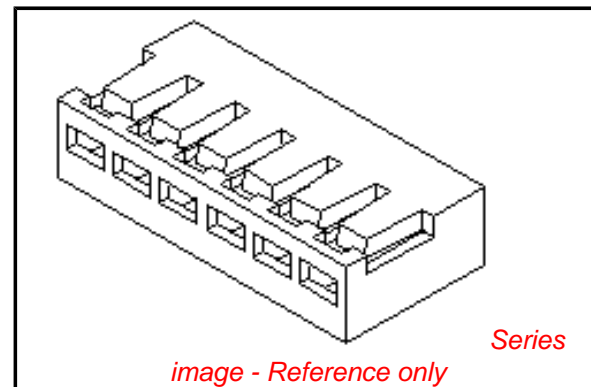

EU RoHS

**ELV and RoHS
 Compliant**
REACH SVHC
 Not Reviewed
**Halogen-Free
 Status**
Not Reviewed

China RoHS



**Need more information on product
 environmental compliance?**

Email productcompliance@molex.com
 For a multiple part number RoHS Certificate of
 Compliance, [click here](#)

Please visit the [Contact Us](#) section for any
 non-product compliance questions.

Search Parts in this Series

[35023Series](#)

Use With

[35044](#) , [35021](#)

DWG. NO. SD 35023-*0**
 SIMILAR ITEM 35023-*0**
 PROJECT NO. 35023-*0**
 DO NOT SCALE DRAWING DIMENSION IN METRIC

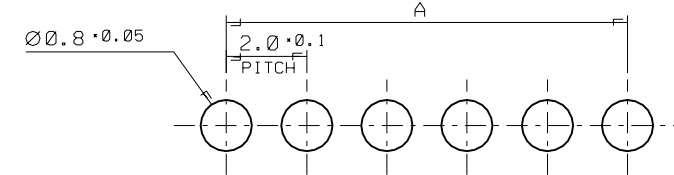
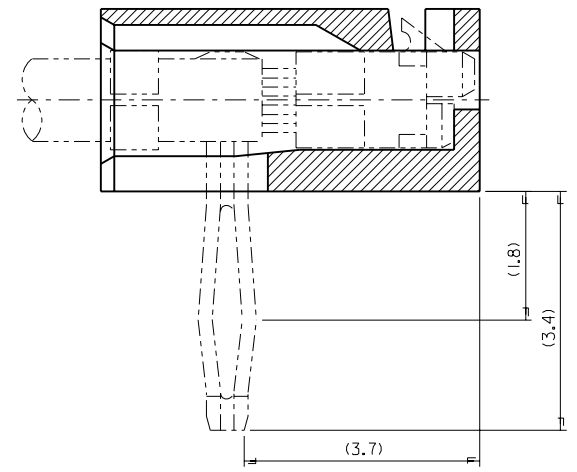
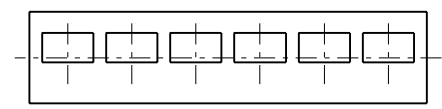
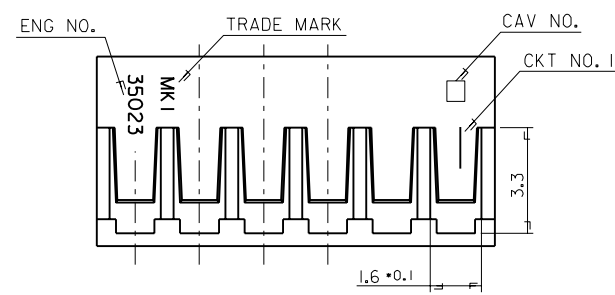
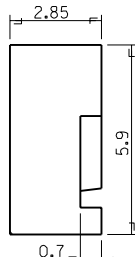
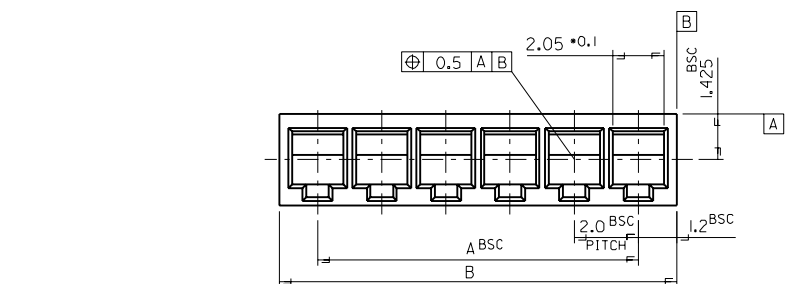

P.C. BOARD LAY OUT
(THK. = 1.6T)

- NOTE
- MATERIAL : NYLON 66 UL94V-0
 - APPLIED TERMINAL : 35021-I201/I301
 - PRODUCT SPECIFICATION : PS-35023

LEGEND

35023 - *0 ** CKT.(02,03,04....)

COLOR : 0 --- NATURAL
 1 --- BLACK

| | | | | | | | |
|------|------|------------|---------|------|------|------------|---------|
| 32.4 | 30.0 | 35023-*016 | 16 | 18.4 | 16.0 | -*009 | 9 |
| 30.4 | 28.0 | -*015 | 15 | 14.4 | 14.0 | -*008 | 8 |
| 28.4 | 26.0 | -*014 | 14 | 12.4 | 10.0 | -*006 | 6 |
| 26.4 | 24.0 | -*013 | 13 | 10.4 | 8.0 | -*005 | 5 |
| 24.4 | 22.0 | -*012 | 12 | 8.4 | 6.0 | -*004 | 4 |
| 22.4 | 20.0 | -*011 | 11 | 6.4 | 4.0 | -*003 | 3 |
| 20.4 | 18.0 | -*010 | 10 | 4.4 | 2.0 | 35023-*002 | 2 |
| B | A | ENG NO. | CKT NO. | B | A | ENG NO. | CKT NO. |

| | | | | | | | | | | | | | |
|---|----------------------------------|-----------------|----------|--|----------|-------------------------------|--------------|--|-------------|--|-----|----------------------------|------------------------------|
| REVISED EC NO. KOR.999-0007 DRWN: K.S.KIM(990111) CHK: J.K.OH APPR: C.W.LEE | DESCRIPTION MAJOR CRITICAL | QUALITY SYMBOLS | | GENERAL TOLERANCES: (UNLESS SPECIFIED) | | SCALE 7-1 | DESIGN UNITS | THIRD ANGLE PROJECTION | DIMENSIONS: | | SHT | REV | |
| | | mm | INCH | mm | INCH | mm | INCH | | mm | INCH | mm | INCH | mm |
| | | 4 PLACES | ±0. | ±. | 4 PLACES | ±0. | ±. | DRAWN BY & DATE H.S.SHIN(931026) | | TITLE: 2.0mm PITCH B-IN CONN. HOUSING(S/T) | | | |
| | | 3 PLACES | ±0. | ±. | 3 PLACES | ±0. | ±. | CHECKED BY & DATE J.K.OH | | | | | |
| 2 PLACES | ±0. | ±. | 2 PLACES | ±0. | ±. | APPROVED BY & DATE C.W.LEE | | MOLEX INCORPORATED KOREA | | | | | |
| 1 PLACE | ±0.3 | ±. | 1 PLACE | ±0.3 | ±. | CAD FILENAME SD35023.DGN | | | | | | MATERIAL NO. 35023-*0** | DRAWING NO. SD 35023-*0** |
| REV | | | | DRAFT WHERE APPLICABLE MUST REMAIN WITHIN DIMENSIONS | | | | THIS DRAWING CONTAINS INFORMATION THAT IS PROPRIETARY TO MOLEX INCORPORATED AND SHOULD NOT BE USED WITHOUT WRITTEN PERMISSION. | | | | MX-A3 | |

