

Features

- Attenuation: 1 dB Steps to 50 dB
- Low DC Power Consumption
- Integral TTL Driver
- 50 ohm Impedance
- Test Boards are Available
- Tape and Reel Packaging Available
- SOW-24 Package

Schematic with Off-Chip Components

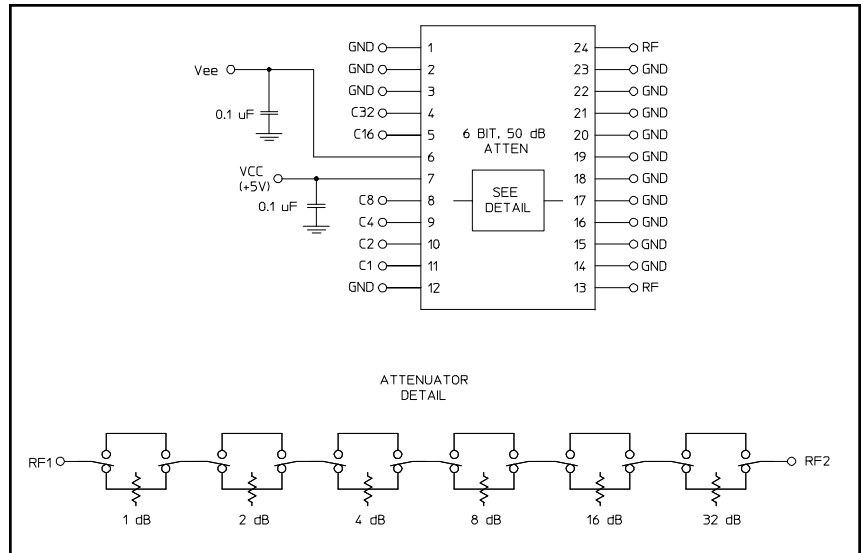

Description

M/A-COM's AT65-0106 is a GaAs FET 6-bit digital attenuator with a 1 dB minimum step size and a 50 dB total attenuation range. This device is in a SOW-24, wide body plastic surface mount package. The AT65-0106 is ideally suited for use where accuracy, fast speed, very low power consumption and low costs are required.

Ordering Information

Part Number	Package
AT65-0106	Bulk Packaging
AT65-0106TR	1000 piece reel
AT65-0106-TB	Sample Test Board

Note: Reference Application Note M513 for reel size information.

Pin Configuration

Pin No.	Function	Pin No.	Function
1	GND	13	RF
2	GND	14	GND
3	GND	15	GND
4	C32	16	GND
5	C16	17	GND
6	V _{EE}	18	GND
7	V _{CC}	19	GND
8	C8	20	GND
9	C4	21	GND
10	C2	22	GND
11	C1	23	GND
12	GND	24	RF

Electrical Specifications: $T_A = 25^\circ\text{C}$, $Z_0 = 50\Omega$

Parameter	Test Conditions	Frequency	Units	Min	Typ	Max
Insertion Loss	—	DC - 2.0 GHz	dB	—	4.2	4.7
Attenuation Accuracy	Individual Bits 1-2-4-8-16-32 dB Any Combination of Bits 3 to 15 dB Any Combination of Bits 17 to 31 dB Any Combination of Bits 32 to 50 dB	DC - 2.0 GHz DC - 2.0 GHz DC - 2.0 GHz DC - 2.0 GHz	dB dB dB dB	— — — —	— — — —	$\pm(.3 + 3\%$ of atten setting) $\pm(.5 + 5\%$ of atten setting) $\pm(.3 + 3\%$ of atten setting) $\pm(.5 + 7\%$ of atten setting)
VSWR	Full Range	DC - 2.0 GHz	Ratio	—	1.8:1	2:1
Switching Speed ¹	50% Cntl to 90%/10% RF 10% to 90% or 90% to 10%	— —	ns ns	— —	75 20	150 50
1 dB Compression	— —	50 MHz 0.5 - 2.0 GHz	dBm dBm	— —	+21 +24	— —
Input IP_3	Two-tone inputs up to +5 dBm @ 0 dB Attenuation	50 MHz 0.5-2.0 GHz	dB dB	— —	+35 +48	— —
V_{CC} V_{EE}	— —	— —	V V	4.75 -8.0	5.0 -5.0	5.25 -4.75
V_{IL} V_{IH}	LOW-level input voltage HIGH-level input voltage	— —	V V	0.0 2.0	— —	0.8 5.0
I_{in} (Input Leakage Current)	$V_{in} = V_{CC}$ or GND	—	μA	-1.0	—	1.0
I_{CC} (Quiescent Supply Current)	$V_{cntrl} = V_{CC}$ or GND	—	μA	—	250	400
ΔI_{CC} (Additional Supply Current Per TTL Input Pin)	$V_{CC} = \text{Max}$, $V_{cntrl} = V_{CC} - 2.1\text{ V}$	—	mA	—	—	1.0
I_{EE}	V_{EE} min to max, $V_{in} = V_{IL}$ or V_{IH}	—	mA	-1.0	-0.2	—
Thermal Resistance θ_{JA}	PCB mount on FR4 material, copper trace, still air at $+25^\circ\text{C}$	—	$^\circ\text{C}/\text{W}$	—	60-80	—

1. Decoupling capacitors (.01 μF) are required on power supply lines.

Absolute Maximum Ratings^{2,3}

Parameter	Absolute Maximum
Max. Input Power 0.05 GHz 0.5 - 2.0 GHz	+27 dBm +34 dBm
V_{CC}	$-0.5\text{V} \leq V_{CC} \leq +7.0\text{V}$
V_{EE}	$-8.5\text{V} \leq V_{EE} \leq +0.5\text{V}$
$V_{CC} - V_{EE}$	$-0.5\text{V} \leq V_{CC} - V_{EE} \leq 14.5\text{V}$
V_{in}^4	$-0.5\text{V} \leq V_{in} \leq V_{CC} + 0.5\text{V}$
Operating Temperature	-40°C to $+85^\circ\text{C}$
Storage Temperature	-65°C to $+125^\circ\text{C}$

- Exceeding any one or combination of these limits may cause permanent damage to this device.
- M/A-COM does not recommend sustained operation near these survivability limits.
- Standard CMOS TTL interface, latch-up will occur if logic signal is applied prior to power supply.

Handling Procedures

Please observe the following precautions to avoid damage:

Static Sensitivity

Gallium Arsenide Integrated Circuits are sensitive to electrostatic discharge (ESD) and can be damaged by static electricity. Proper ESD control techniques should be used when handling these devices.

Truth Table (Digital Attenuator)

C32	C16	C8	C4	C2	C1	Attenuation
0	0	0	0	0	0	Loss, Reference
0	0	0	0	0	1	1 dB
0	0	0	0	1	0	2 dB
0	0	0	1	0	0	4 dB
0	0	1	0	0	0	8 dB
0	1	0	0	0	0	16 dB
1	0	0	0	0	0	32 dB
1	1	0	0	1	0	50 dB

0 = TTL Low; 1 = TTL High

Typical Performance Curves

Insertion Loss vs. Temperature

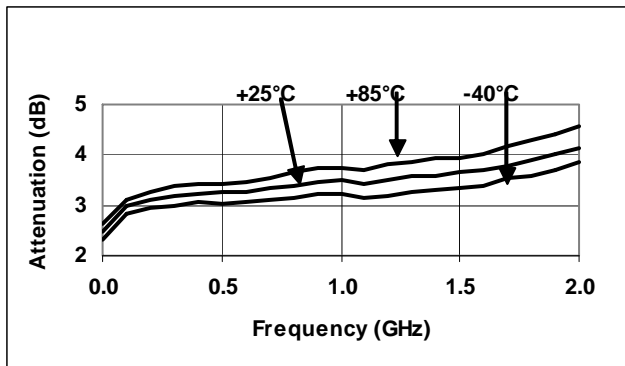

1 dB Attenuation Variation from -40°C to +85°C

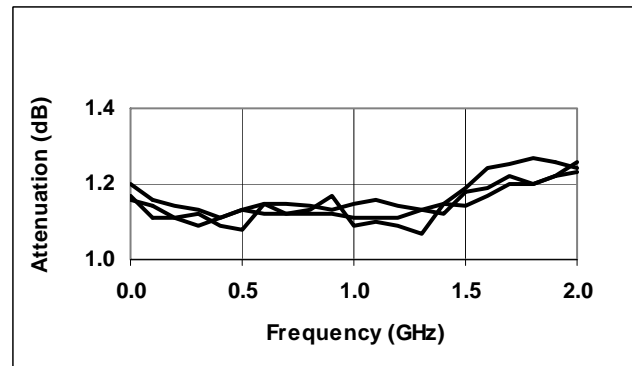

2 dB Attenuation Variation from -40°C to +85°C

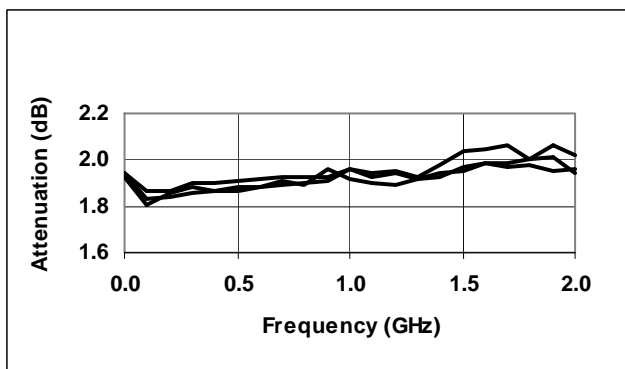

4 dB Attenuation Variation from -40°C to +85°C

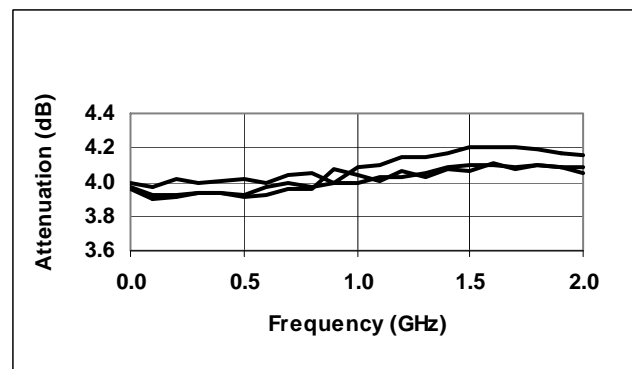

Typical Performance Curves

8 dB Attenuation Variation from -40°C to +85°C

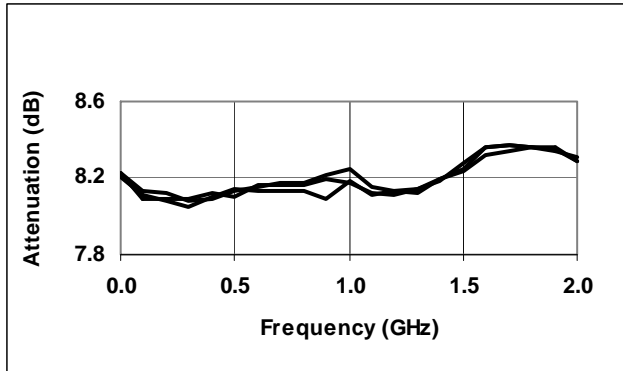

16 dB Attenuation Variation from -40°C to +85°C

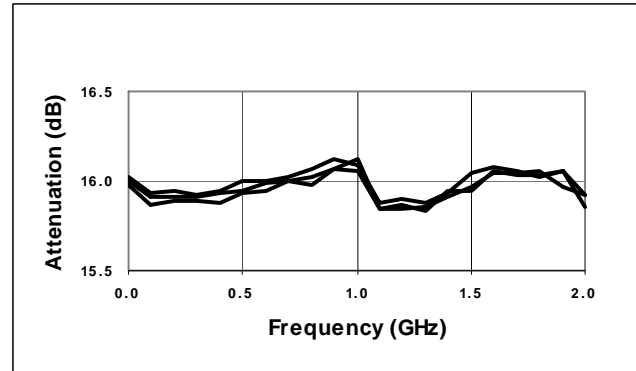

32 dB Attenuation Variation from -40°C to +85°C

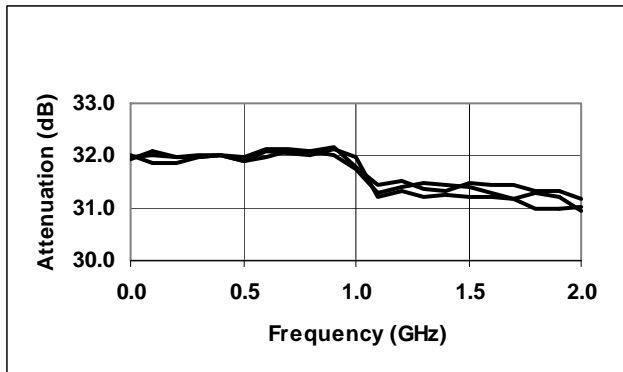

Max. Attenuation Variation from -40°C to +85°C

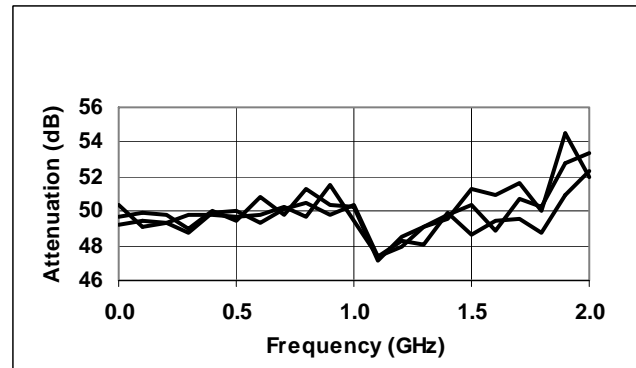

Reference Loss VSWR (S11, S22)

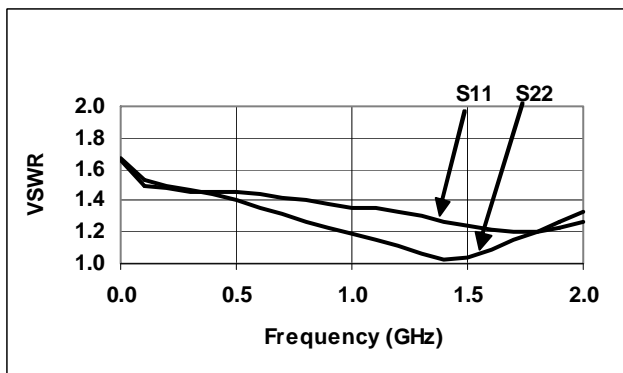

1 dB VSWR (S11, S22)

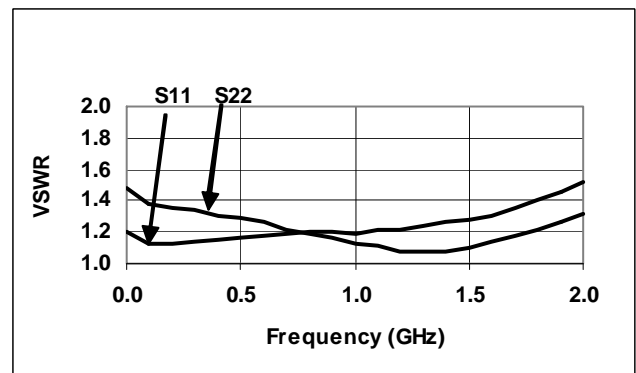

Typical Performance Curves

2 dB VSWR (S11, S22)

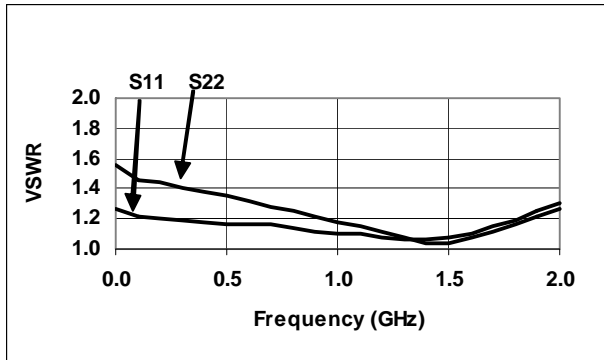

4 dB VSWR (S11, S22)

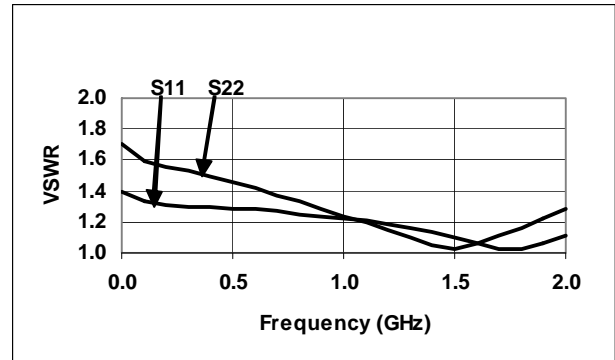

8 dB VSWR (S11, S22)

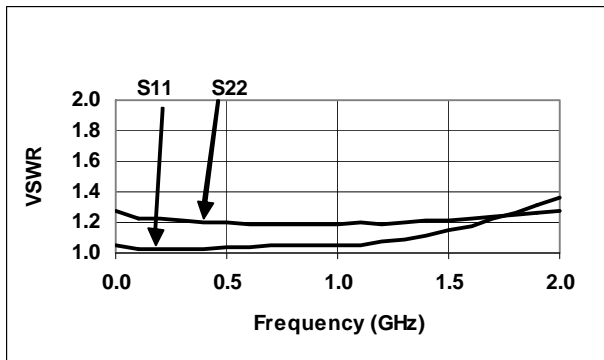

16 dB VSWR (S11, S22)

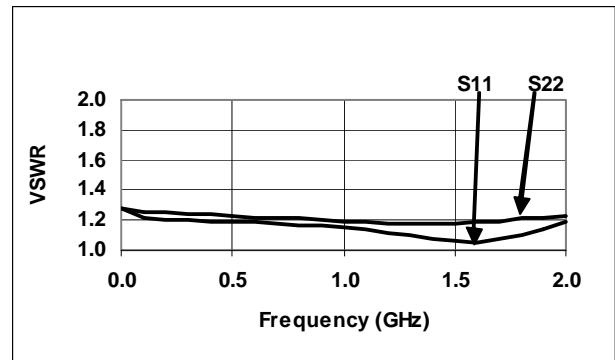

32 dB VSWR (S11, S22)

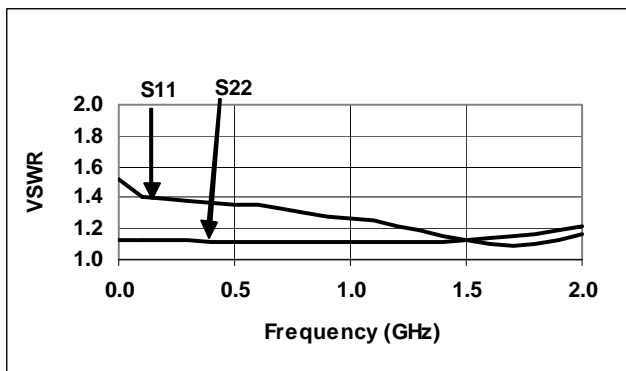

50 dB VSWR (S11, S22)

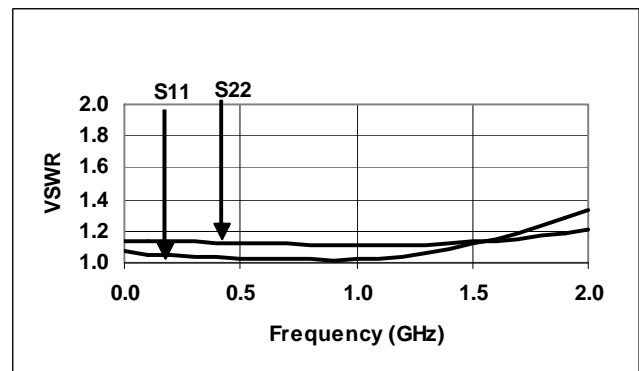

AT65-0106

Digital Attenuator
50 dB, 6-Bit, TTL Driver, DC-2.0 GHz

Rev. V9

SOW-24†

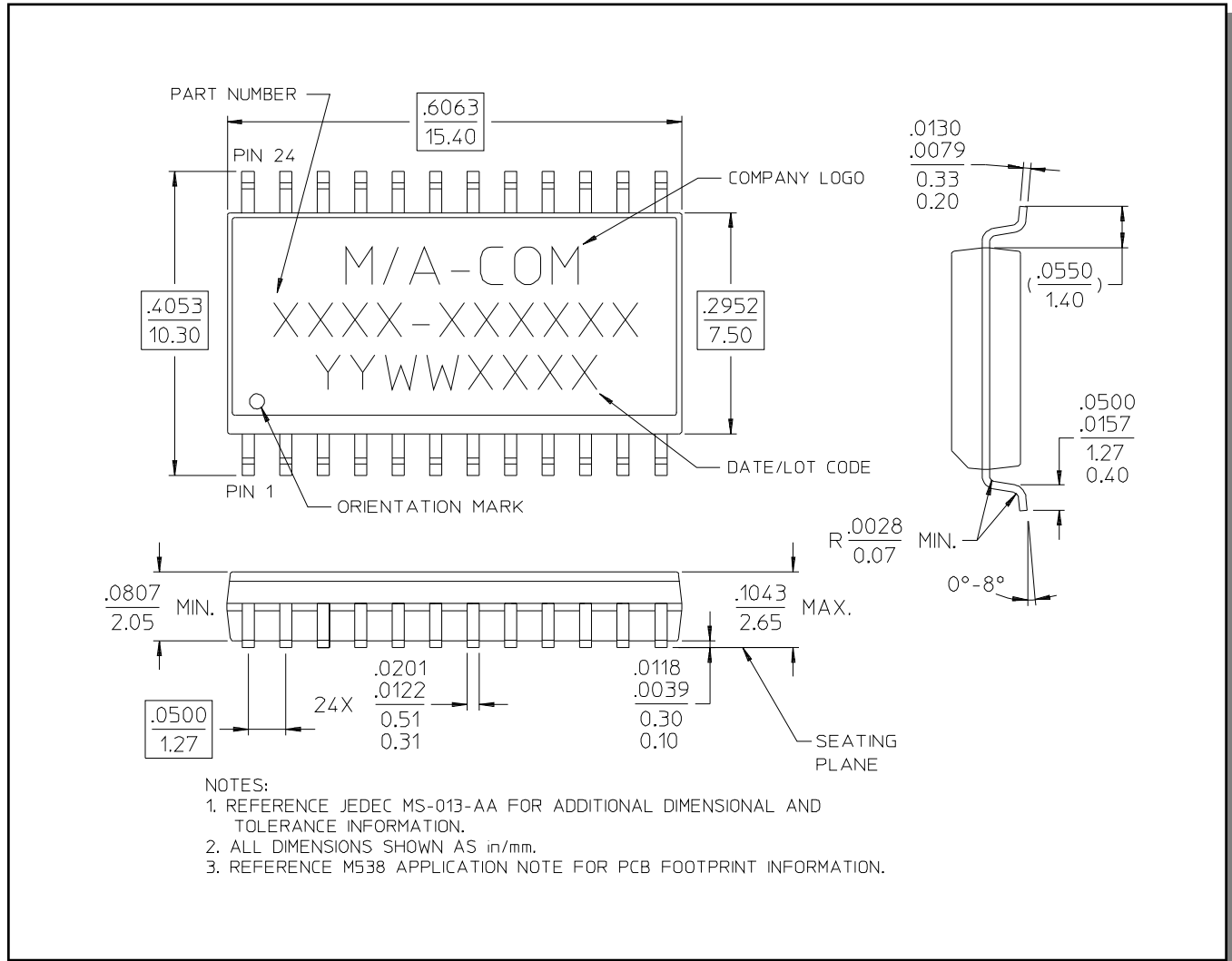

† Reference Application Note M538 for lead-free solder reflow recommendations.