

**PLEASE CHECK WWW.MOLEX.COM FOR LATEST PART INFORMATION**

**Part Number:** [0458440004](#)  
**Status:** **Active**  
**Overview:** edge card connectors  
**Description:** 2.50mm (.098") Pitch EXTreme PowerEdge™, Signal Connector, Double Sided, 2 Segments (8 Signal Contacts Per Segment), Through Hole Solder for 1.57mm (.062") Thick PC Board

**Documents:**

[3D Model](#) [Product Specification PS-45719-001 \(PDF\)](#)  
[Drawing \(PDF\)](#) [RoHS Certificate of Compliance \(PDF\)](#)

**Agency Certification**

CSA LR 19980  
 UL E29179

**General**

Product Family Edge Card Connectors  
 Series [45844](#)  
 Component Type Edgecard to PCB  
 Overview [edge\\_card\\_connectors](#)  
 Product Name EXTreme PowerEdge™

**Physical**

Circuits (Loaded) 16  
 Circuits (maximum) 16  
 Circuits Detail All Signal  
 Color - Resin Black  
 Durability (mating cycles max) 250  
 Entry Angle Vertical (Top Entry)  
 Flammability 94V-0  
 Keying to Mating Part N/A  
 Material - Metal Phosphor Bronze  
 Material - Plating Mating Gold  
 Material - Plating Termination Tin  
 Material - Resin High Temperature Thermoplastic  
 PC Tail Length (in) 0.126 In  
 PC Tail Length (mm) 3.19 mm  
 PCB Thickness Recommended (in) 0.062 In  
 PCB Thickness Recommended (mm) 1.60 mm  
 Packaging Type Tray  
 Pitch - Mating Interface (in) 0.098 In  
 Pitch - Mating Interface (mm) 2.50 mm  
 Plating min: Mating (µin) 30  
 Plating min: Mating (µm) 0.75  
 Plating min: Termination (µin) 150  
 Plating min: Termination (µm) 3.75  
 Temperature Range - Operating -40°C to +105°C  
 Termination Interface: Style Through Hole

**Electrical**

Current - Maximum per Contact 3A  
 Voltage - Maximum 250V

**Solder Process Data**

Duration at Max. Process Temperature (seconds) 5  
 Lead-free Process Capability Wave Capable (TH only)  
 Max. Cycles at Max. Process Temperature 1

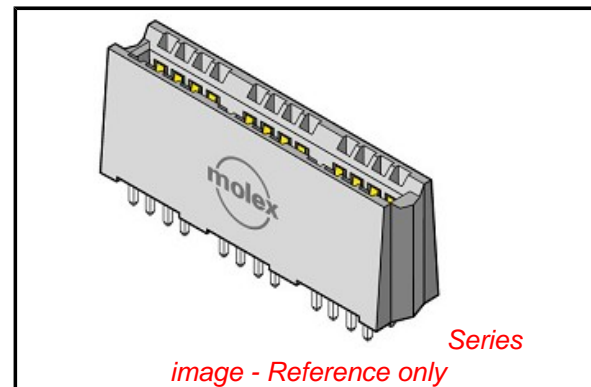

**EU RoHS**

**ELV and RoHS  
 Compliant**  
**REACH SVHC  
 Contains SVHC: No**  
**Halogen-Free  
 Status**

**China RoHS**



**Need more information on product  
 environmental compliance?**

Email [productcompliance@molex.com](mailto:productcompliance@molex.com)  
 For a multiple part number RoHS Certificate of  
 Compliance, [click here](#)

Please visit the [Contact Us](#) section for any  
 non-product compliance questions.

**Search Parts in this Series**

[45844Series](#)

**Mates With**

1.58mm (.062") double sided card edge

Process Temperature max. C 250

**Material Info**

**Reference - Drawing Numbers**

Packaging Specification	PK-45714-001
Product Specification	PS-45719-001
Sales Drawing	SD-45844-001

This document was generated on 06/04/2010

**PLEASE CHECK [WWW.MOLEX.COM](http://WWW.MOLEX.COM) FOR LATEST PART INFORMATION**

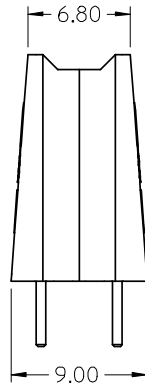
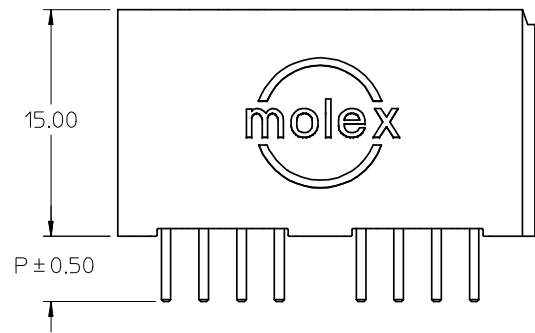
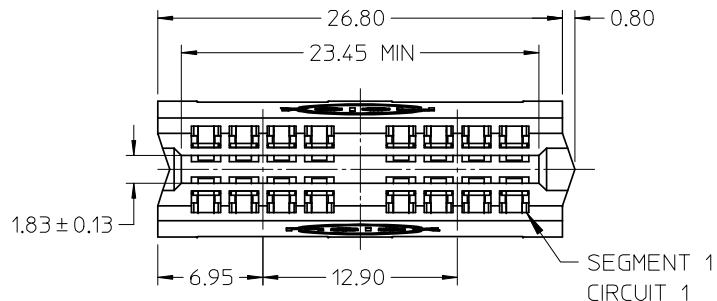

NOTES:

- HOUSING MATL: LCP, UL94V-0, BLACK  
TERMINAL MATL: COPPER ALLOY
- FINISH: SELECT GOLD: 30 M.I. MIN IN CONTACT AREA  
SELECT TIN: 150 M.I. MIN IN SOLDER AREA  
BOTH OVER NICKEL: 50 M.I. MIN
- PRODUCT SPECIFICATION: PS-45719-001.
- PACKAGING SPECIFICATION: PK-45714-001.
- PCB THICKNESS: SEE CHART
- EDGE CARD THICKNESS: 1.57 ± 0.15
- DIMENSIONS GIVEN ACROSS CENTERLINES ARE SYMMETRICAL ABOUT THOSE CENTERLINES WITHIN HALF THE TOTAL TOLERANCE.
- 0.50 X 45° CHAMFER ON LEADING EDGE, TYP 4 SIDES.

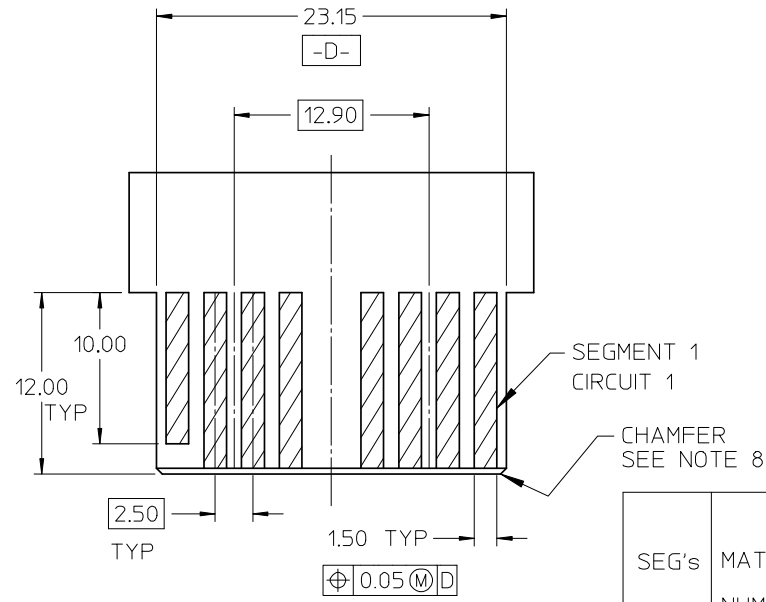
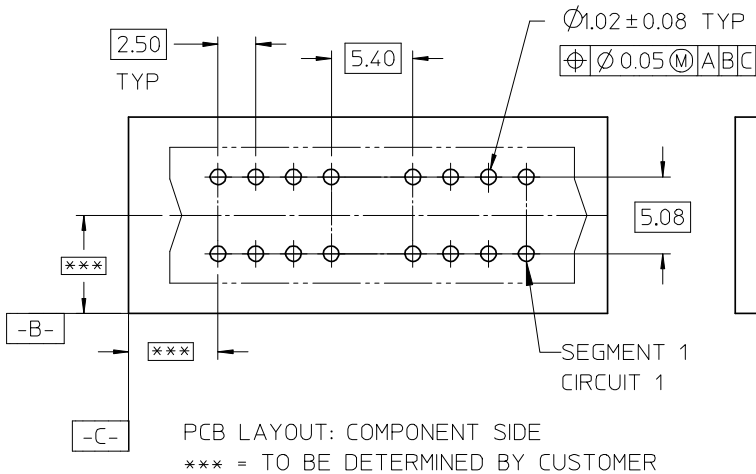

SEG's	MATERIAL NUMBER	DIM P	PCB THK
2	45844-0001	4.33	3.18/2.36
2	45844-0004	3.19	1.57

REVISE SLOT TOL.	2008/04/16
EC NO: UCP2008-2498	2008/04/16
DRWN: JSCHAER	2008/04/22
CHKD: CHKD:	2008/04/22
APPR: APATEL	2008/04/25
REV	DESCRIPTION

GENERAL TOLERANCES (UNLESS SPECIFIED)	
	mm INCH
4 PLACES	± --- ± ---
3 PLACES	± --- ± ---
2 PLACES	± 0.25 ± ---
1 PLACE	± --- ± ---
ANGULAR ± 1/2°	
DRAFT WHERE APPLICABLE MUST REMAIN WITHIN DIMENSIONS	

DIMENSION STYLE	
MM ONLY	
DRAWN BY	DATE
MARGUL IS	2004/07/29
CHECKED BY	DATE
MARGUL IS	2004/07/29
APPROVED BY	DATE
MARGUL IS	2004/07/29
SEE CHART	
SIZE	A

SCALE	2:1	DESIGN UNITS	METRIC	THIRD ANGLE PROJECTION
TITLE				
POWER EDGE ASSEMBLY SIGNAL VERTICAL SOLDER TAIL				
MOLEX MOLEX INCORPORATED				
DOCUMENT NO.				SHEET NO.
SD-45844-001				1 OF 3

SEE SHEET ONE FOR NOTES AND DIMENSIONS NOT SHOWN

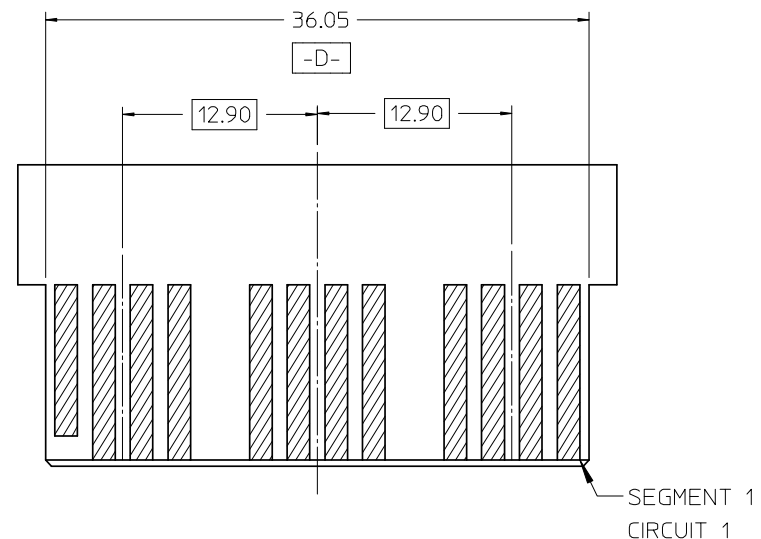
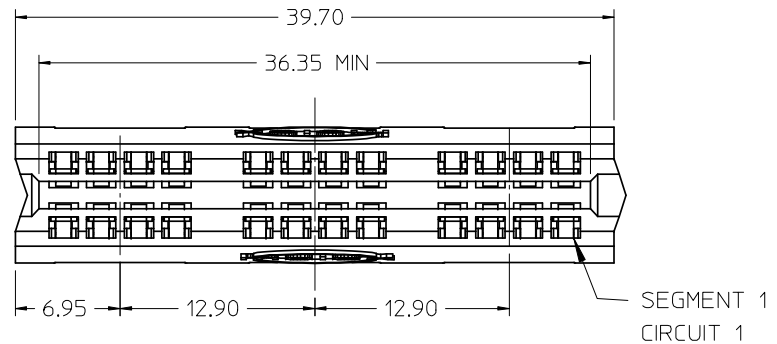

RECOMMENDED EDGE CARD LAYOUT:  
TOLERANCE: ±0.05

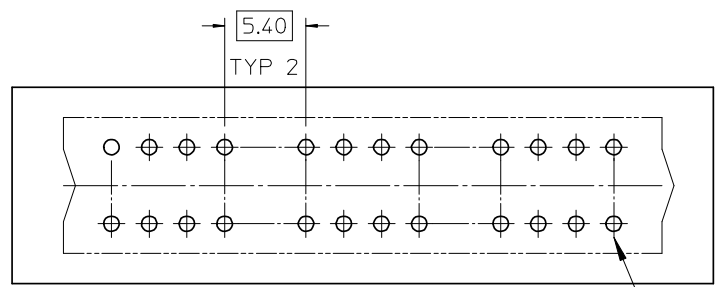
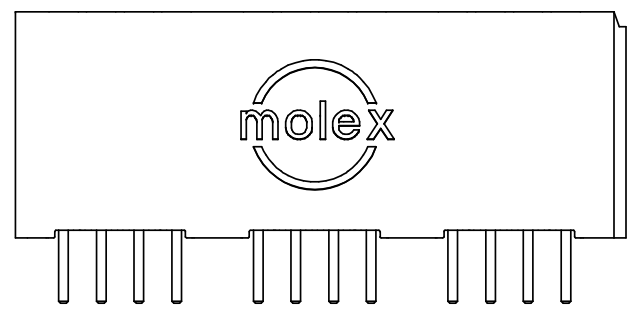

PBC LAYOUT: COMPONENT SIDE

SEG's	MATERIAL NUMBER	DIM P	PCB THK
3	45844-0002	4.33	3.18/2.36
3	45844-0005	3.19	1.57

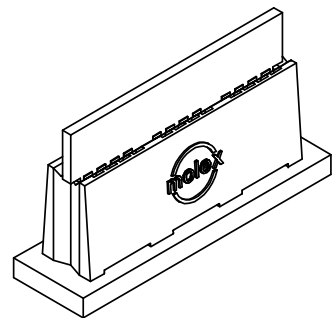

EC NO: UCP2008-2498	DRWN: JSCHAFFER	2008/04/16	DESCRIPTION
CHKD: APATEL	2008/04/22		
APPR: APATEL	2008/04/25		
REV			

GENERAL TOLERANCES (UNLESS SPECIFIED)		
	mm	INCH
4 PLACES	± ---	± ---
3 PLACES	± ---	± ---
2 PLACES	± 0.25	± ---
1 PLACE	± ---	± ---
ANGULAR ±1/2°		
DRAFT WHERE APPLICABLE MUST REMAIN WITHIN DIMENSIONS		

DIMENSION STYLE	
MM ONLY	
DRAWN BY	DATE
MARGULIS	2004/07/29
CHECKED BY	DATE
MARGULIS	2004/07/29
APPROVED BY	DATE
MARGULIS	2004/07/29
MATERIAL NUMBER	SEE CHART

SCALE	DESIGN UNITS	THIRD ANGLE PROJECTION
2:1	METRIC	
TITLE		
POWER EDGE ASSEMBLY SIGNAL VERTICAL SOLDER TAIL		
molex MOLEX INCORPORATED		
DOCUMENT NO.	SHEET NO.	
SD-45844-001	2	
THIS DRAWING CONTAINS INFORMATION THAT IS PROPRIETARY TO MOLEX INCORPORATED AND SHOULD NOT BE USED WITHOUT WRITTEN PERMISSION		

SEE SHEET ONE FOR NOTES AND DIMENSIONS NOT SHOWN

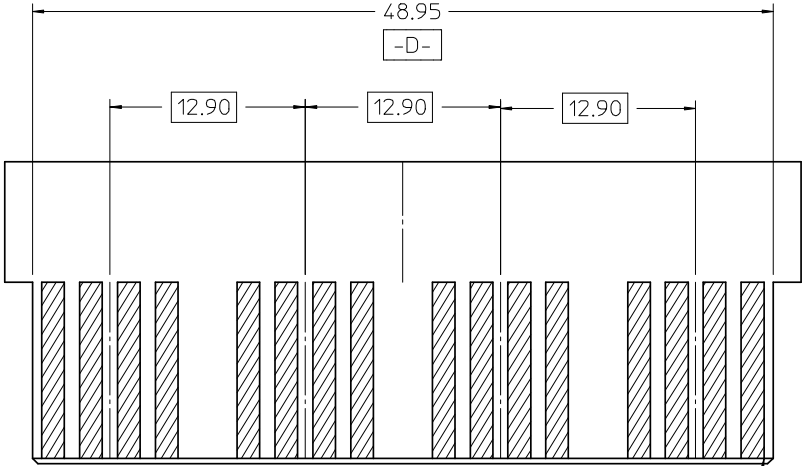

RECOMMENDED EDGE CARD LAYOUT  
TOLERANCE: ±0.05

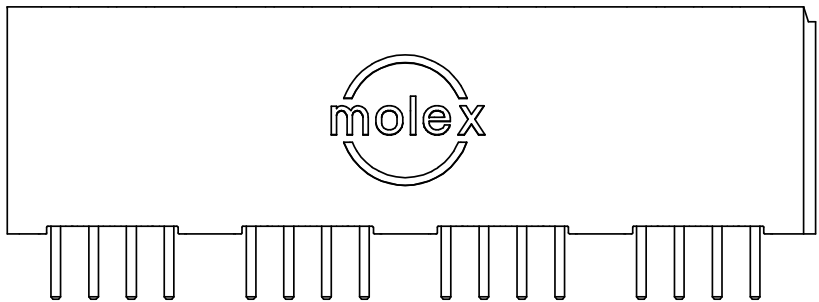

5.40  
TYP 3

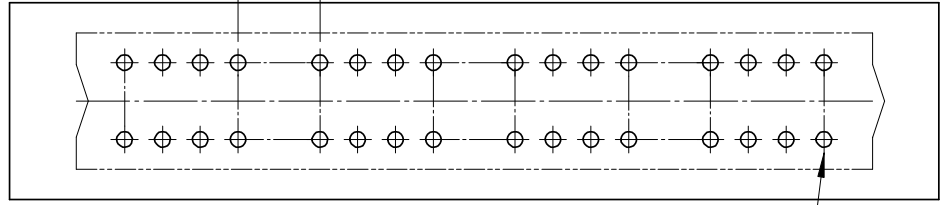

PCB LAYOUT: COMPONENT SIDE

SEG's	MATERIAL NUMBER	DIM P	PCB THK
4	45844-0003	4.33	3.18/2.36
4	45844-0006	3.19	1.57

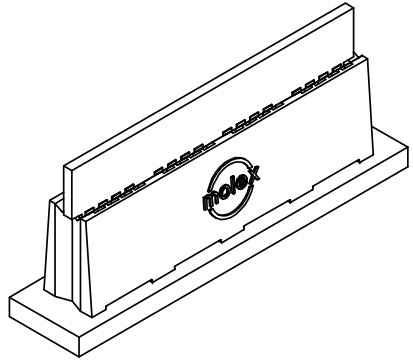

EC NO: UCP2008-2498	DRWN: JSCHAFFER	2008/04/16	2008/04/22
CH'KD: APPR: APATEL	2008/04/25		
REV	DESCRIPTION		
D			

GENERAL TOLERANCES (UNLESS SPECIFIED)		
	mm	INCH
4 PLACES	± ---	± ---
3 PLACES	± ---	± ---
2 PLACES	± 0.25	± ---
1 PLACE	± ---	± ---
ANGULAR ±1/2°		
DRAFT WHERE APPLICABLE MUST REMAIN WITHIN DIMENSIONS		

DIMENSION STYLE	
MM ONLY	
DRAWN BY	DATE
MARGUL IS	2004/07/29
CHECKED BY	DATE
MARGUL IS	2004/07/29
APPROVED BY	DATE
MARGUL IS	2004/07/29
MATERIAL NUMBER	
SEE CHART	

SCALE	DESIGN UNITS	THIRD ANGLE PROJECTION
2:1	METRIC	
TITLE		
POWER EDGE ASSEMBLY SIGNAL VERTICAL SOLDER TAIL		
MOLEX INCORPORATED		
DOCUMENT NO.		SHEET NO.
SD-45844-001		3
THIS DRAWING CONTAINS INFORMATION THAT IS PROPRIETARY TO MOLEX INCORPORATED AND SHOULD NOT BE USED WITHOUT WRITTEN PERMISSION		