

PLEASE CHECK WWW.MOLEX.COM FOR LATEST PART INFORMATION

Part Number: [0458440005](#)
Status: **Active**
Overview: edge card connectors
Description: 2.50mm (.098") Pitch EXTreme PowerEdge™, Signal Connector, Double Sided, 3 Segments (8 Signal Contacts Per Segment), Through Hole Solder for 1.57mm (.062") Thick PC Board

Documents:

[3D Model](#) [Product Specification PS-45719-001 \(PDF\)](#)
[Drawing \(PDF\)](#) [RoHS Certificate of Compliance \(PDF\)](#)

Agency Certification

CSA LR 19980
 UL E29179

General

Product Family Edge Card Connectors
 Series [45844](#)
 Component Type Edgecard to PCB
 Overview [edge_card_connectors](#)
 Product Name EXTreme PowerEdge™

Physical

Circuits (Loaded) 24
 Circuits (maximum) 24
 Circuits Detail All Signal
 Color - Resin Black
 Durability (mating cycles max) 250
 Entry Angle Vertical (Top Entry)
 Flammability 94V-0
 Keying to Mating Part N/A
 Material - Metal Phosphor Bronze
 Material - Plating Mating Gold
 Material - Plating Termination Tin
 Material - Resin High Temperature Thermoplastic
 PC Tail Length (in) 0.126 In
 PC Tail Length (mm) 3.19 mm
 PCB Thickness Recommended (in) 0.062 In
 PCB Thickness Recommended (mm) 1.60 mm
 Packaging Type Tray
 Pitch - Mating Interface (in) 0.098 In
 Pitch - Mating Interface (mm) 2.50 mm
 Plating min: Mating (µin) 30
 Plating min: Mating (µm) 0.75
 Plating min: Termination (µin) 150
 Plating min: Termination (µm) 3.75
 Temperature Range - Operating -40°C to +105°C
 Termination Interface: Style Through Hole

Electrical

Current - Maximum per Contact 3A
 Voltage - Maximum 250V

Solder Process Data

Duration at Max. Process Temperature (seconds) 5
 Lead-free Process Capability Wave Capable (TH only)
 Max. Cycles at Max. Process Temperature 1

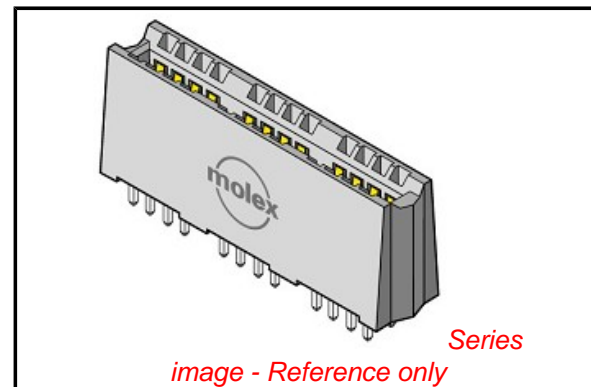

EU RoHS

**ELV and RoHS
 Compliant**
**REACH SVHC
 Contains SVHC: No**
**Halogen-Free
 Status**

China RoHS



**Need more information on product
 environmental compliance?**

Email productcompliance@molex.com
 For a multiple part number RoHS Certificate of Compliance, [click here](#)

Please visit the [Contact Us](#) section for any non-product compliance questions.

Search Parts in this Series

[45844Series](#)

Mates With

1.58mm (.062") double sided card edge

Process Temperature max. C 250

Material Info

Reference - Drawing Numbers

Packaging Specification	PK-45714-001
Product Specification	PS-45719-001
Sales Drawing	SD-45844-001

This document was generated on 06/04/2010

PLEASE CHECK WWW.MOLEX.COM FOR LATEST PART INFORMATION

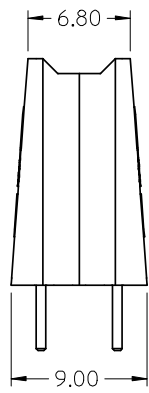
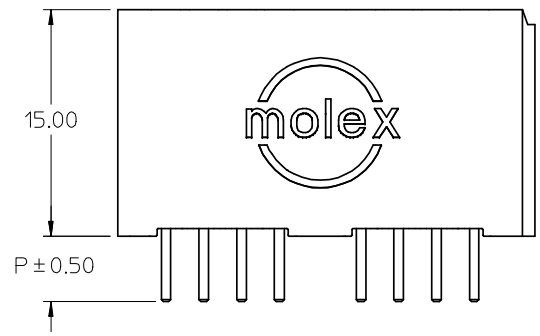
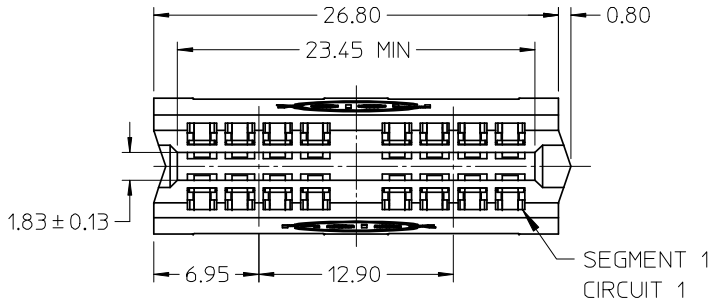

- NOTES:
- HOUSING MATL: LCP, UL94V-0, BLACK
TERMINAL MATL: COPPER ALLOY
 - FINISH: SELECT GOLD: 30 M.I. MIN IN CONTACT AREA
SELECT TIN: 150 M.I. MIN IN SOLDER AREA
BOTH OVER NICKEL: 50 M.I. MIN
 - PRODUCT SPECIFICATION: PS-45719-001.
 - PACKAGING SPECIFICATION: PK-45714-001.
 - PCB THICKNESS: SEE CHART
 - EDGE CARD THICKNESS: 1.57 ± 0.15
 - DIMENSIONS GIVEN ACROSS CENTERLINES ARE SYMMETRICAL ABOUT THOSE CENTERLINES WITHIN HALF THE TOTAL TOLERANCE.
 - 0.50 X 45° CHAMFER ON LEADING EDGE, TYP 4 SIDES.

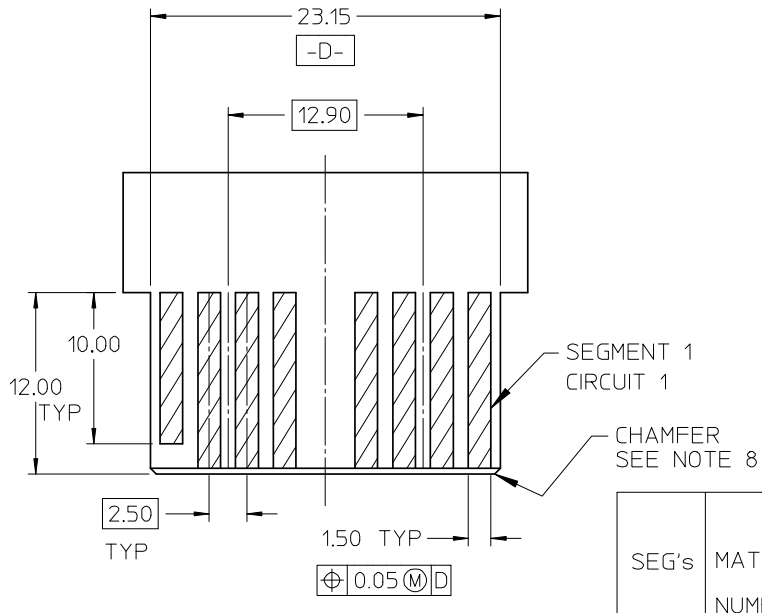
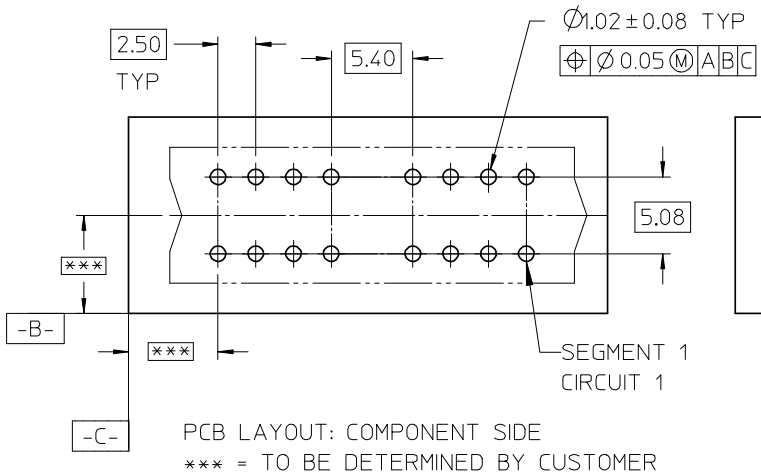

SEG's	MATERIAL NUMBER	DIM P	PCB THK
2	45844-0001	4.33	3.18/2.36
2	45844-0004	3.19	1.57

REVISE SLOT TOL.	2008/04/16
EC NO: UCP2008-2498	2008/04/22
DRWN: JSCHAER	2008/04/25
CHKD: CHKD:	
APPR: APATEL	
REV	DESCRIPTION

GENERAL TOLERANCES (UNLESS SPECIFIED)	
	mm INCH
4 PLACES	± --- ± ---
3 PLACES	± --- ± ---
2 PLACES	± 0.25 ± ---
1 PLACE	± --- ± ---
ANGULAR ± 1/2°	
DRAFT WHERE APPLICABLE MUST REMAIN WITHIN DIMENSIONS	

DIMENSION STYLE	
MM ONLY	
DRAWN BY	DATE
MARGUL IS	2004/07/29
CHECKED BY	DATE
MARGUL IS	2004/07/29
APPROVED BY	DATE
MARGUL IS	2004/07/29
SEE CHART	
SIZE	A

SCALE	2:1	DESIGN UNITS	METRIC	THIRD ANGLE PROJECTION
TITLE				
POWER EDGE ASSEMBLY SIGNAL VERTICAL SOLDER TAIL				
MOLEX INCORPORATED				
DOCUMENT NO.				SHEET NO.
SD-45844-001				1 OF 3
THIS DRAWING CONTAINS INFORMATION THAT IS PROPRIETARY TO MOLEX INCORPORATED AND SHOULD NOT BE USED WITHOUT WRITTEN PERMISSION				

6

5

4

3

2

1

SEE SHEET ONE FOR NOTES AND DIMENSIONS NOT SHOWN

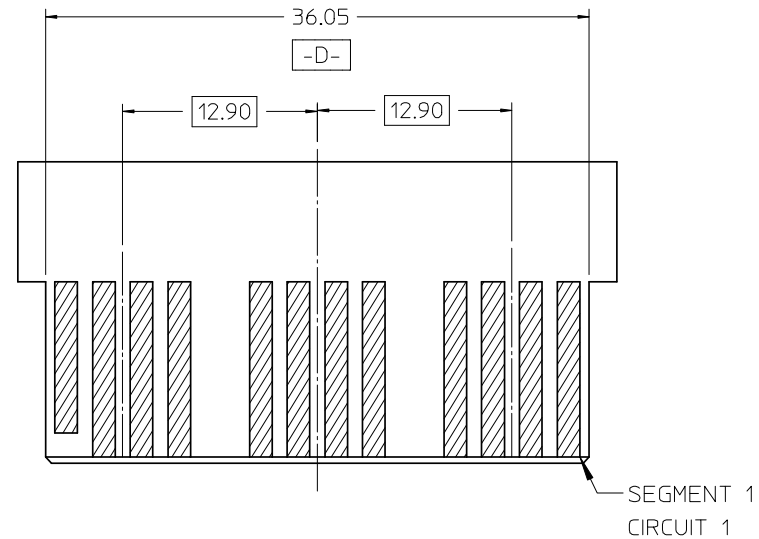
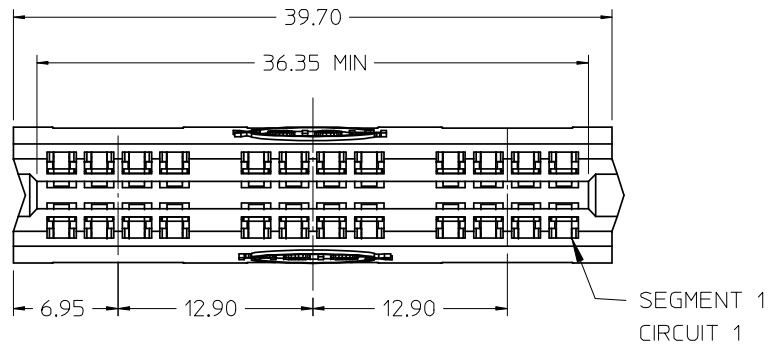

RECOMMENDED EDGE CARD LAYOUT:
TOLERANCE: ± 0.05

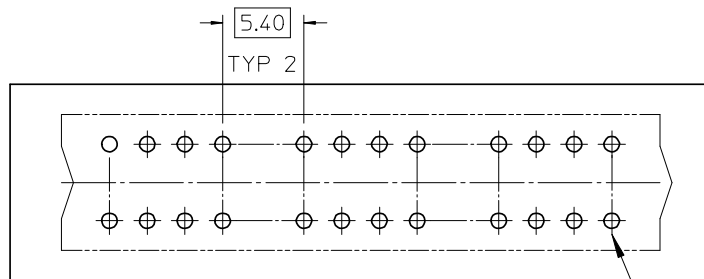
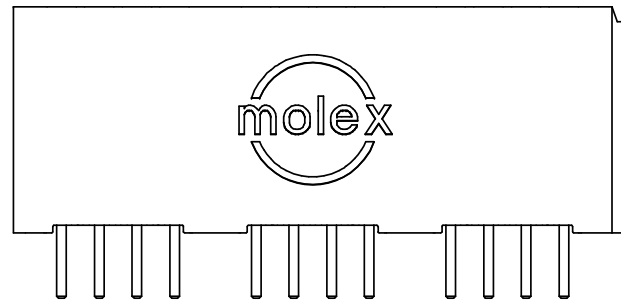

PBC LAYOUT: COMPONENT SIDE

SEG's	MATERIAL NUMBER	DIM P	PCB THK
3	45844-0002	4.33	3.18/2.36
3	45844-0005	3.19	1.57

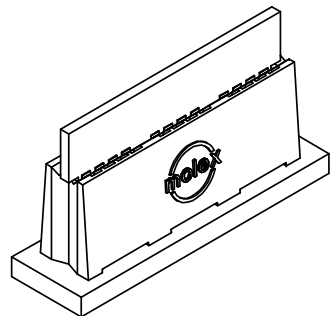

EC NO: UCP2008-2498	DRWN: JSCHAFFER	2008/04/16	2008/04/22	CHKD:	2008/04/25	APPR: APATEL	DESCRIPTION
D	REV						

GENERAL TOLERANCES
(UNLESS SPECIFIED)

	mm	INCH
4 PLACES	\pm ---	\pm ---
3 PLACES	\pm ---	\pm ---
2 PLACES	± 0.25	\pm ---
1 PLACE	\pm ---	\pm ---

ANGULAR $\pm 1/2^\circ$

DRAFT WHERE APPLICABLE
MUST REMAIN
WITHIN DIMENSIONS

DIMENSION STYLE
MM ONLY

DRAWN BY	DATE
MARGULIS	2004/07/29
CHECKED BY	DATE
MARGULIS	2004/07/29
APPROVED BY	DATE
MARGULIS	2004/07/29

MATERIAL NUMBER
SEE CHART

SIZE
A

THIS DRAWING CONTAINS INFORMATION THAT IS PROPRIETARY TO MOLEX
INCORPORATED AND SHOULD NOT BE USED WITHOUT WRITTEN PERMISSION

SCALE
2:1

DESIGN UNITS
METRIC

THIRD ANGLE
PROJECTION

TITLE
POWER EDGE ASSEMBLY
SIGNAL VERTICAL
SOLDER TAIL

molex MOLEX INCORPORATED

DOCUMENT NO.
SD-45844-001

SHEET NO.
2

SEE SHEET ONE FOR NOTES AND DIMENSIONS NOT SHOWN

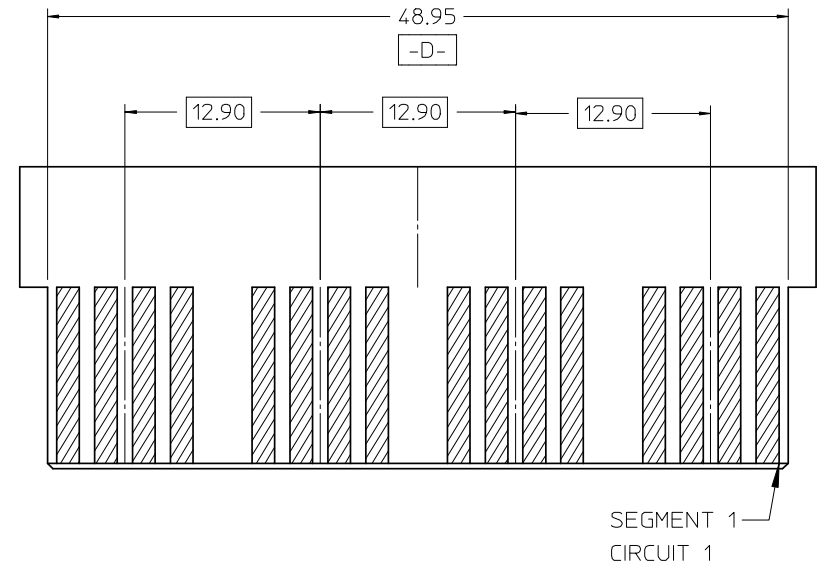
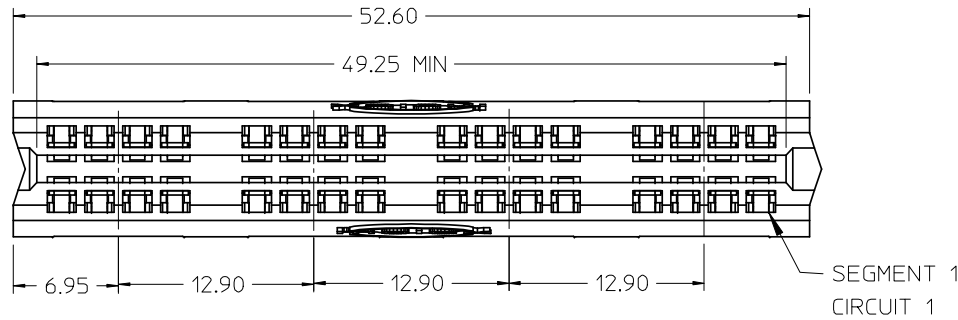

RECOMMENDED EDGE CARD LAYOUT
TOLERANCE: ±0.05

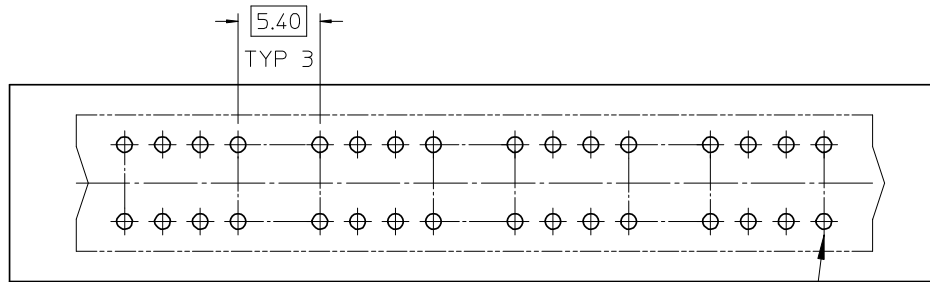
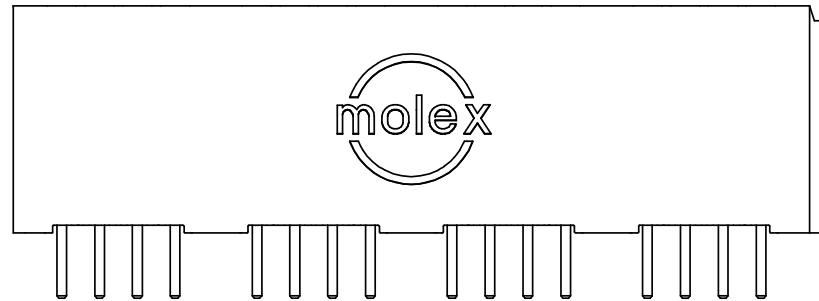

PCB LAYOUT: COMPONENT SIDE

SEG's	MATERIAL NUMBER	DIM P	PCB THK
4	45844-0003	4.33	3.18/2.36
4	45844-0006	3.19	1.57

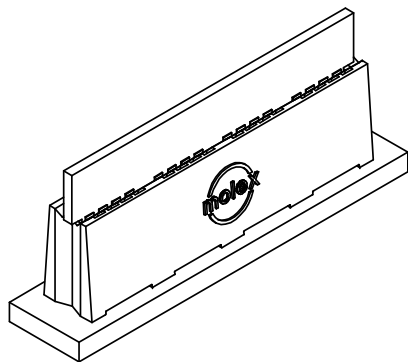

EC NO: UCP2008-2498	2008/04/16	DESCRIPTION
DRWN: JSCHAFFER	2008/04/22	
CHKD: APATEL	2008/04/25	
APPR: APATEL	2008/04/25	
REV		

GENERAL TOLERANCES (UNLESS SPECIFIED)

	mm	INCH
4 PLACES	± ---	± ---
3 PLACES	± ---	± ---
2 PLACES	± 0.25	± ---
1 PLACE	± ---	± ---

ANGULAR ±1/2°

DRAFT WHERE APPLICABLE
MUST REMAIN
WITHIN DIMENSIONS

DIMENSION STYLE
MM ONLY

DRAWN BY	DATE
MARGUL IS	2004/07/29
CHECKED BY	DATE
MARGUL IS	2004/07/29
APPROVED BY	DATE
MARGUL IS	2004/07/29

MATERIAL NUMBER
SEE CHART

SIZE
A

SCALE
2:1

TITLE

DOCUMENT NO.
SD-45844-001

SHEET NO.
3

DESIGN UNITS
METRIC

THIRD ANGLE PROJECTION

POWER EDGE ASSEMBLY
SIGNAL VERTICAL
SOLDER TAIL

MOLEX INCORPORATED