

# LITEON LITE-ON TECHNOLOGY CORPORATION

Property of LITON Only

## FEATURES

- \* SNAP MOUNTING.
- \* MECHANICAL SWITCH REPLACEMENT.
- \* THREE WIRES FOR ELECTRICAL CONNECTION.
- \* GUARANTEED ACTUATOR LIFE  $10^6$  TIMES.

## PACKAGE DIMENSIONS

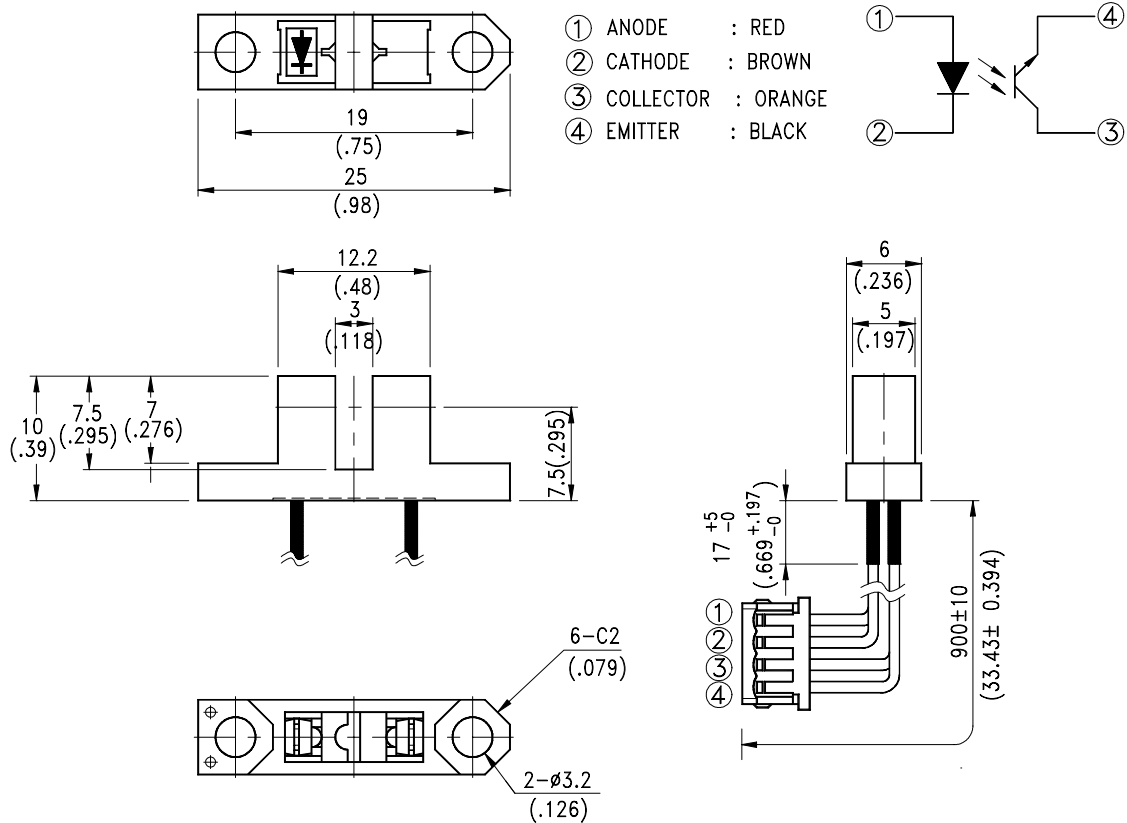

## NOTES:

1. All dimensions are in millimeters (inches).
2. Tolerance is  $\pm 0.25\text{mm}$  (.010") unless otherwise noted.



# LITE-ON TECHNOLOGY CORPORATION

Property of LITON Only

## ABSOLUTE MAXIMUM RATINGS AT TA=25

PARAMETER	MAXIMUM RATING	UNIT
<b>INPUT LED</b>		
Power Dissipation	75	mW
Peak Forward Current ( 300 pps , 10 $\mu$ S pulse)	1	A
Continuous Forward Current	50	mA
Reverse Voltage	5	V
<b>OUTPUT PHOTOTRANSISTOR</b>		
Power Dissipation	100	mW
Collector-Emitter Voltage	30	V
Emitter-Collector Voltage	5	V
Collector Current	20	mA
Operating Temperature Range	-25 to + 85	
Storage Temperature Range	-40 to + 100	
Lead Soldering Temperature [ 1.6mm (.063") Form Case ]	260 for 5 Seconds	



# LITE-ON TECHNOLOGY CORPORATION

Property of LITON Only

## ELECTRICAL OPTICAL CHARACTERISTICS AT TA=25

PARAMETER	SYMBOL	MIN.	TYP.	MAX.	UNIT	TEST CONDITION
INPUT LED						
Forward Voltage	$V_F$		1.2	1.6	V	$I_F = 20\text{mA}$
Reverse Current	$I_R$			100	$\mu\text{A}$	$V_R=5\text{V}$
OUTPUT PHOTOTRANSISTOR						
Collector-Emitter Dark Current	$I_{CEO}$			100	nA	$V_{CE}=10\text{V}$
COUPLER						
Collector-Emitter Saturation Voltage	$V_{CE(SAT)}$			0.4	V	$I_C=0.25\text{mA}$ $I_F=20\text{mA}$
On State Collector Current	$I_{C(ON)}$	0.5	1.2		mA	$V_{CE}=5\text{V}$ $I_F=20\text{mA}$
Response Time	Rise Time	$T_r$	3	15	$\mu\text{S}$	$V_{CE}=5\text{V}, I_C=2\text{mA}$ $R_L=100\Omega$
	Fall Time	$T_f$	4	20		

## TYPICAL ELECTRICAL / OPTICAL CHARACTERISTICS CURVES

(25 Ambient Temperature Unless Otherwise Noted)

Fig.1 Power Dissipation vs. Ambient Temperature

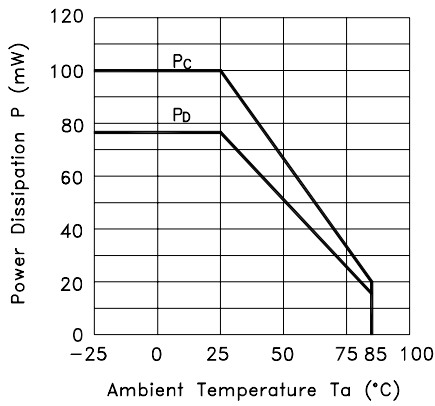

Fig.2 Forward Current vs. Forward Voltage

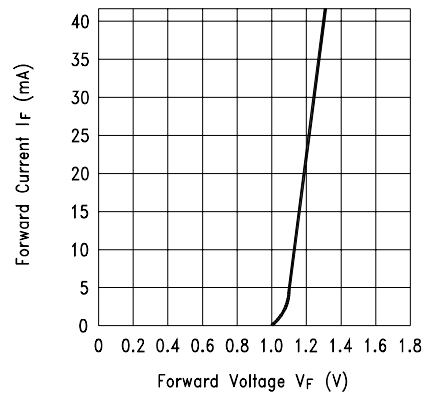

Fig.3 Collector Current vs. Collector-emitter Voltage

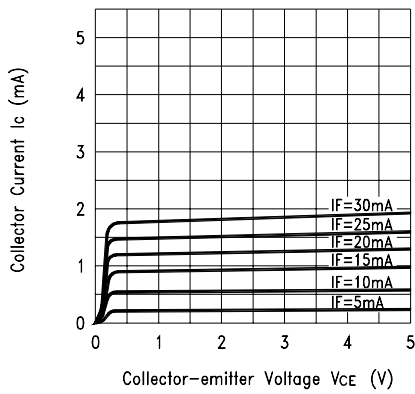
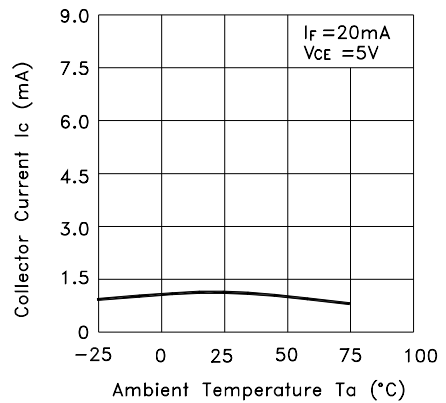

Fig.4 Collector Current vs. Ambient Temperature



## TYPICAL ELECTRICAL / OPTICAL CHARACTERISTICS CURVES

(25 Ambient Temperature Unless Otherwise Noted)

Fig.5 Response Time vs. Load Resistance

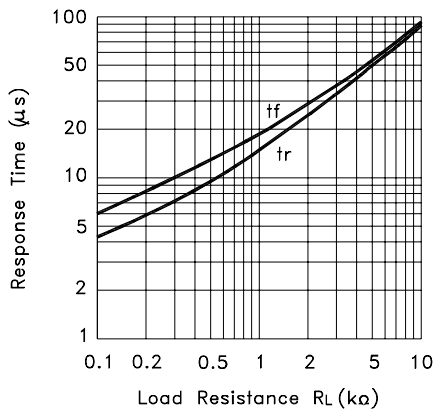

Test Circuit for Response Time

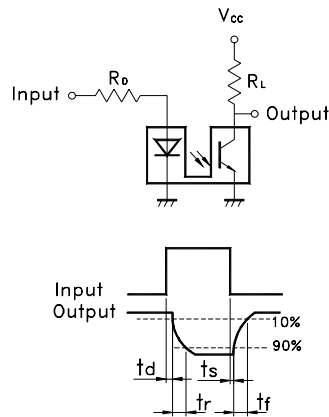

Fig.6 Collector-emitter Saturation Voltage vs. Ambient Temperature

