

## FEATURES

- \* NON-CONTACT SWITCHING.
- \* FOR DIRECT PC BOARD OR DUAL-IN-LINE SOCKET MOUNTING.
- \* FAST SWITCHING SPEED.

## PACKAGE DIMENSIONS

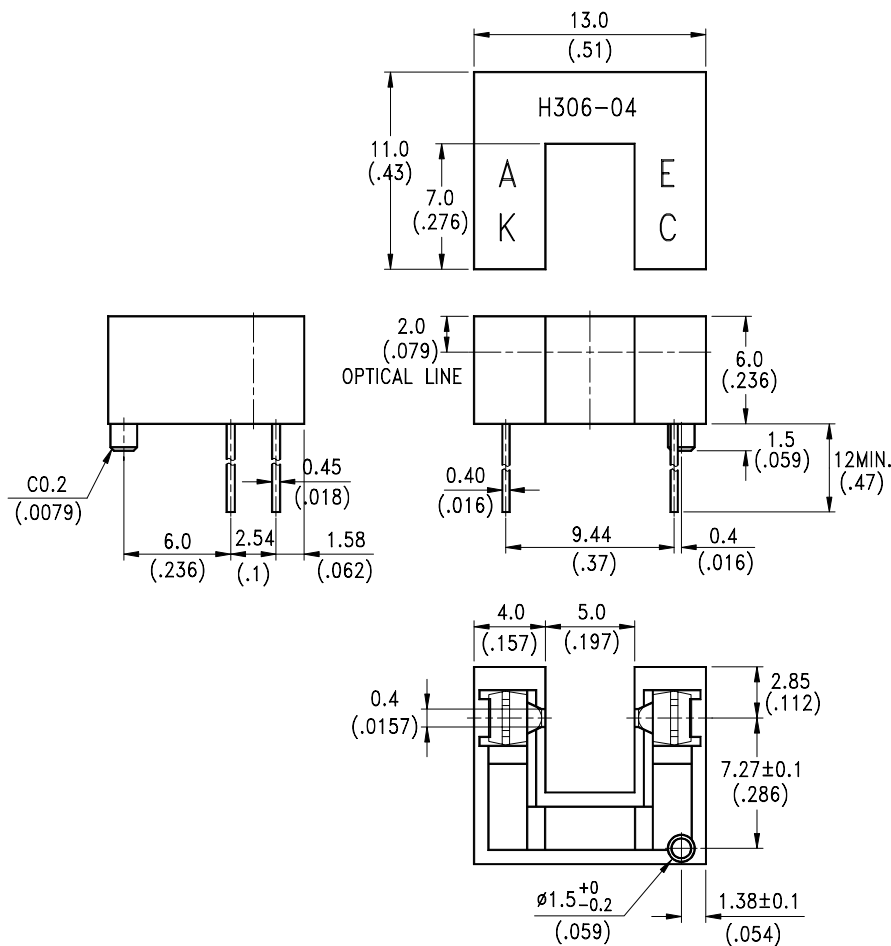

### NOTES:

1. All dimensions are in millimeters (inches).
2. Tolerance is  $\pm 0.25$  mm (.010") unless otherwise noted.
3. Lead spacing is measured where the leads emerge from the package.

## ABSOLUTE MAXIMUM RATINGS AT T<sub>A</sub>=25

PARAMETER	MAXIMUM RATING	UNIT
INPUT LED		
Power Dissipation	75	mW
Peak Forward Current ( 300 pps , 10 $\mu$ S pulse)	1	A
Continuous Forward Current	60	mA
Reverse Voltage	5	V
OUTPUT PHOTOTRANSISTOR		
Power Dissipation	100	mW
Collector-Emitter Voltage	30	V
Emitter-Collector Voltage	5	V
Collector Current	20	mA
Operating Temperature Range	-25 to + 85	
Storage Temperature Range	-40 to + 100	
Lead Soldering Temperature [ 1.6mm (.063") Form Case ]	260 for 5 Seconds	

## ELECTRICAL OPTICAL CHARACTERISTICS AT TA=25

PARAMETER	SYMBOL	MIN.	TYP.	MAX.	UNIT	TEST CONDITION
<b>INPUT LED</b>						
Forward Voltage	$V_F$		1.2	1.6	V	$I_F = 20\text{mA}$
Reverse Current	$I_R$			100	$\mu\text{A}$	$V_R = 5\text{V}$
<b>OUTPUT PHOTOTRANSISTOR</b>						
Collector-Emitter Dark Current	$I_{CEO}$			100	nA	$V_{CE} = 10\text{V}$
<b>COUPLER</b>						
Collector-Emitter Saturation Voltage	$V_{CE(SAT)}$			0.4	V	$I_C = 0.25\text{mA}$ $I_F = 20\text{mA}$
On State Collector Current	$I_{C(ON)}$	0.5	2		mA	$V_{CE} = 5\text{V}$ $I_F = 20\text{mA}$
Response Time	Rise Time	$t_r$	3	15	$\mu\text{S}$	$V_{CE} = 5\text{V}, I_C = 2\text{mA}$ $R_L = 100$
	Fall Time	$t_f$	4	20		

## TYPICAL ELECTRICAL / OPTICAL CHARACTERISTICS CURVES

(25 Ambient Temperature Unless Otherwise Noted)

Fig.1 Power Dissipation vs. Ambient Temperature

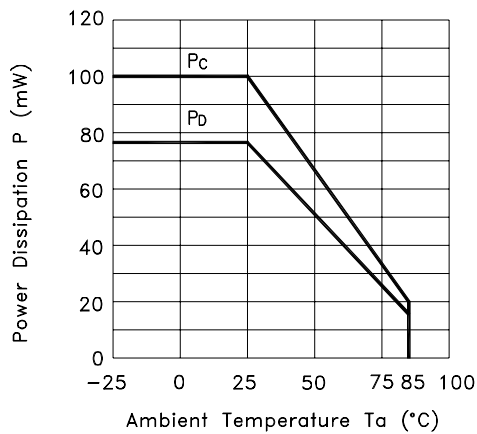

Fig.2 Forward Current vs. Forward Voltage

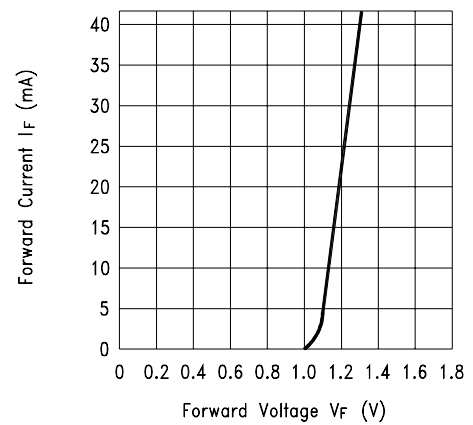

Fig.3 Collector Current vs. Collector-emitter Voltage

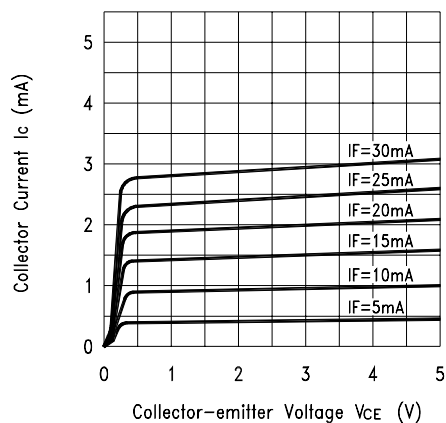
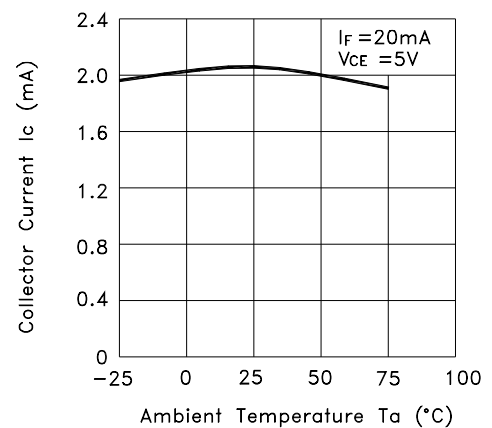

Fig.4 Collector Current vs. Ambient Temperature



## TYPICAL ELECTRICAL / OPTICAL CHARACTERISTICS CURVES

(25 Ambient Temperature Unless Otherwise Noted)

Fig.5 Collector-emitter Saturation Voltage vs. Ambient Temperature

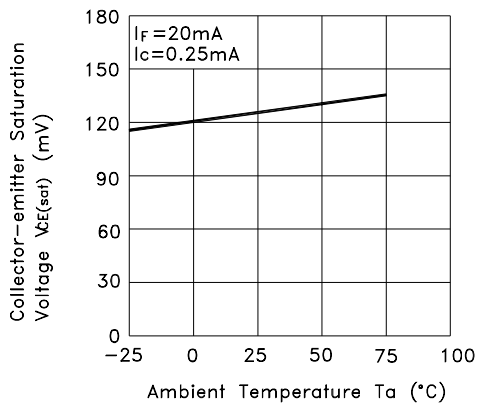
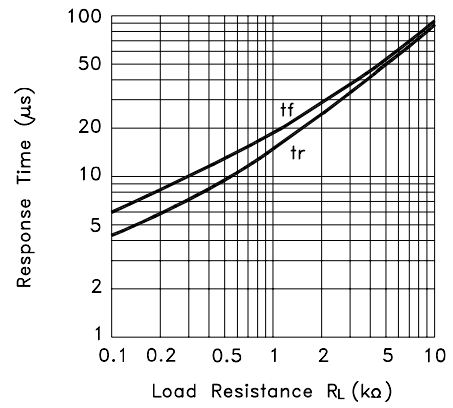

Fig.6 Response Time vs. Load Resistance



Test Circuit for Response Time

