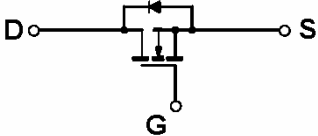

20V N-Channel Enhancement Mode MOSFET

<p>SOT-23</p>  <p>Pin assignment: 1. Gate 2. Source 3. Drain</p>	<p>V_{DS} = 20V R_{DS} (on), V_{GS} @ 4.5V, I_{DS} @ 3.6A = 65mΩ R_{DS} (on), V_{GS} @ 2.5V, I_{DS} @ 3.1A = 95mΩ</p>								
<p>Features</p> <ul style="list-style-type: none"> ◇ Advanced trench process technology ◇ High density cell design for ultra low on-resistance 	<ul style="list-style-type: none"> ◇ Excellent thermal and electrical capabilities ◇ Compact and low profile SOT-23 package 								
<p>Block Diagram</p> 	<p>Ordering Information</p> <table border="1" data-bbox="850 996 1433 1081"> <thead> <tr> <th>Part No.</th> <th>Packing</th> <th>Package</th> </tr> </thead> <tbody> <tr> <td>RTM2302CX</td> <td>Tape & Reel</td> <td>SOT-23</td> </tr> </tbody> </table>			Part No.	Packing	Package	RTM2302CX	Tape & Reel	SOT-23
Part No.	Packing	Package							
RTM2302CX	Tape & Reel	SOT-23							
<p>Absolute Maximum Rating (Ta = 25°C unless otherwise noted)</p>									
<p>Parameter</p>	<p>Symbol</p>	<p>Limit</p>	<p>Unit</p>						
<p>Drain-Source Voltage</p>	<p>V_{DS}</p>	<p>20V</p>	<p>V</p>						
<p>Gate-Source Voltage</p>	<p>V_{GS}</p>	<p>± 8</p>	<p>V</p>						
<p>Continuous Drain Current</p>	<p>I_D</p>	<p>2.4</p>	<p>A</p>						
<p>Pulsed Drain Current</p>	<p>I_{DM}</p>	<p>10</p>	<p>A</p>						
<p>Maximum Power Dissipation</p>	<p>Ta = 25°C</p>	<p>1.25</p>	<p>W</p>						
	<p>Ta = 75°C</p>	<p>0.8</p>							
<p>Operating Junction Temperature</p>	<p>T_J</p>	<p>+150</p>	<p>°C</p>						
<p>Operating Junction and Storage Temperature Range</p>	<p>T_J, T_{STG}</p>	<p>- 55 to +150</p>	<p>°C</p>						
<p>Thermal Performance</p>									
<p>Parameter</p>	<p>Symbol</p>	<p>Limit</p>	<p>Unit</p>						
<p>Lead Temperature (1/8" from case)</p>	<p>T_L</p>	<p>5</p>	<p>S</p>						
<p>Junction to Ambient Thermal Resistance (PCB mounted)</p>	<p>R_{θja}</p>	<p>100</p>	<p>°C/W</p>						

Note: Surface mounted on FR4 board t<=5sec.

Electrical Characteristics						
Rate $I_D = 2.4A$, ($T_a = 25^\circ C$ unless otherwise noted)						
Parameter	Conditions	Symbol	Min	Typ	Max	Unit
Static						
Drain-Source Breakdown Voltage	$V_{GS} = 0V, I_D = 250\mu A$	BV_{DSS}	20	--	--	V
Drain-Source On-State Resistance	$V_{GS} = 4.5V, I_D = 3.6A$	$R_{DS(ON)}$	--	50	65	m Ω
Drain-Source On-State Resistance	$V_{GS} = 2.5V, I_D = 3.1A$	$R_{DS(ON)}$	--	75	95	
Gate Threshold Voltage	$V_{DS} = V_{GS}, I_D = 250\mu A$	$V_{GS(TH)}$	0.45	--	--	V
Zero Gate Voltage Drain Current	$V_{DS} = 20V, V_{GS} = 0V$	I_{DSS}	--	--	1.0	μA
Gate Body Leakage	$V_{GS} = \pm 8V, V_{DS} = 0V$	I_{GSS}	--	--	± 100	nA
On-State Drain Current	$V_{DS} \geq 5V, V_{GS} = 4.5V$	$I_{D(ON)}$	6	--	--	A
Forward Transconductance	$V_{DS} = 5V, I_D = 3.6A$	g_{fs}	--	10	--	S
Dynamic						
Total Gate Charge	$V_{DS} = 10V, I_D = 3.6A, V_{GS} = 4.5V$	Q_g	--	5.2	10	nC
Gate-Source Charge		Q_{gs}	--	0.65	--	
Gate-Drain Charge		Q_{gd}	--	1.5	--	
Turn-On Delay Time	$V_{DD} = 10V, R_L = 10\Omega, I_D = 1A, V_{GEN} = 4.5V, R_G = 6\Omega$	$t_{d(on)}$	--	7	15	nS
Turn-On Rise Time		t_r	--	55	80	
Turn-Off Delay Time		$t_{d(off)}$	--	16	60	
Turn-Off Fall Time		t_f	--	10	25	
Input Capacitance	$V_{DS} = 10V, V_{GS} = 0V, f = 1.0MHz$	C_{iss}	--	450	--	pF
Output Capacitance		C_{oss}	--	70	--	
Reverse Transfer Capacitance		C_{rss}	--	43	--	
Source-Drain Diode						
Max. Diode Forward Current		I_S	--	--	1.6	A
Diode Forward Voltage	$I_S = 1.0A, V_{GS} = 0V$	V_{SD}	--	0.75	1.2	V

Note : pulse test: pulse width $\leq 300\mu S$, duty cycle $\leq 2\%$

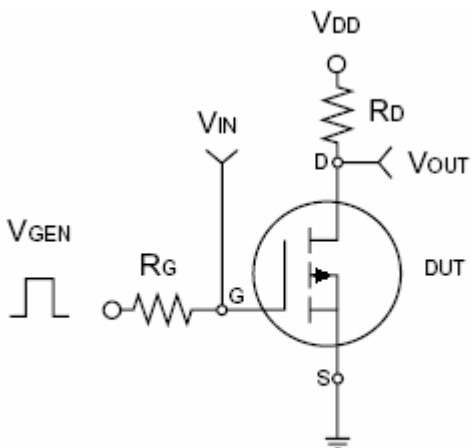

Switching Test Circuit

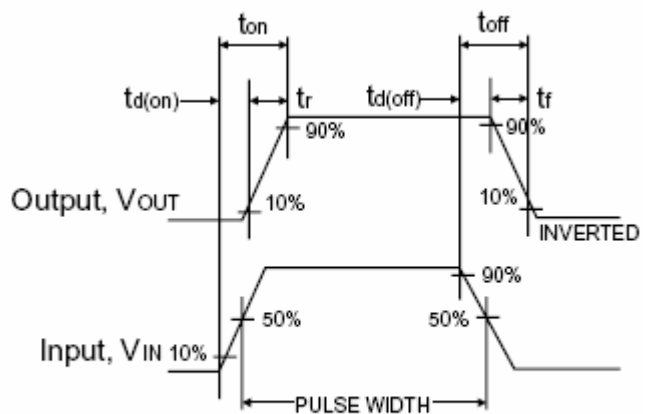

Switchin Waveforms

Typical Characteristics Curve (Ta = 25 °C unless otherwise noted)

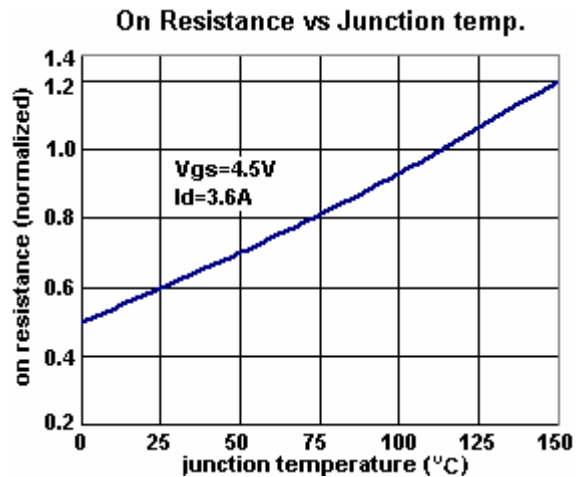
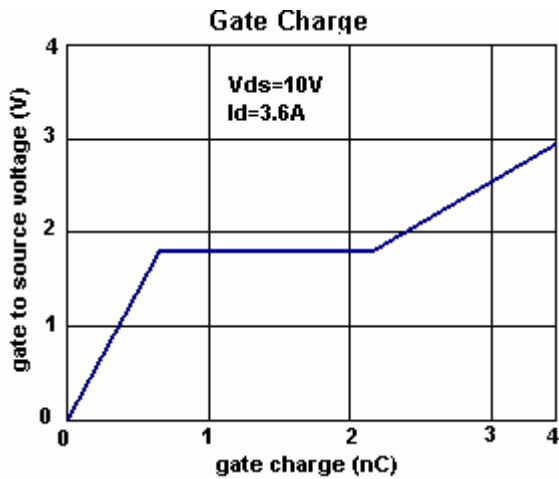
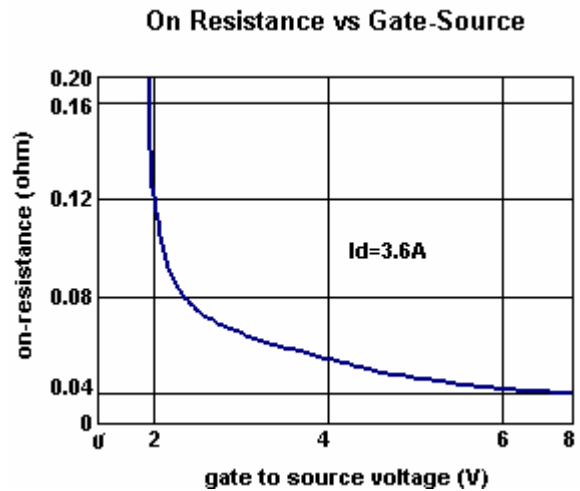
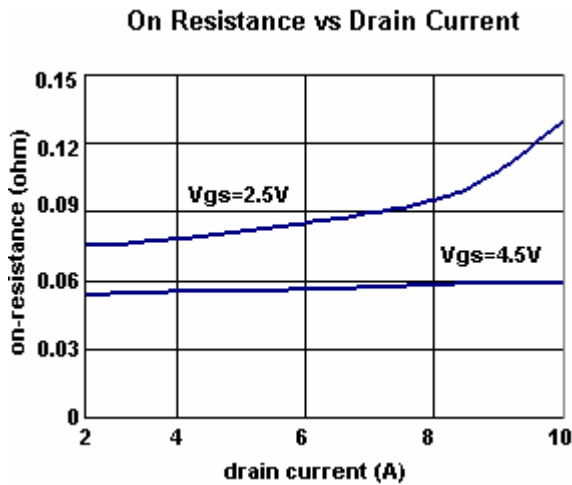
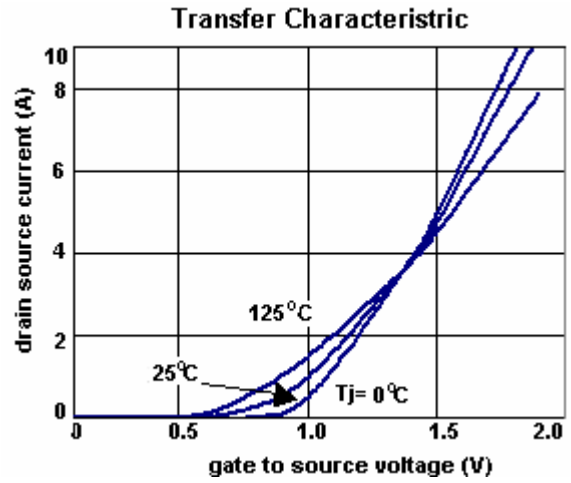
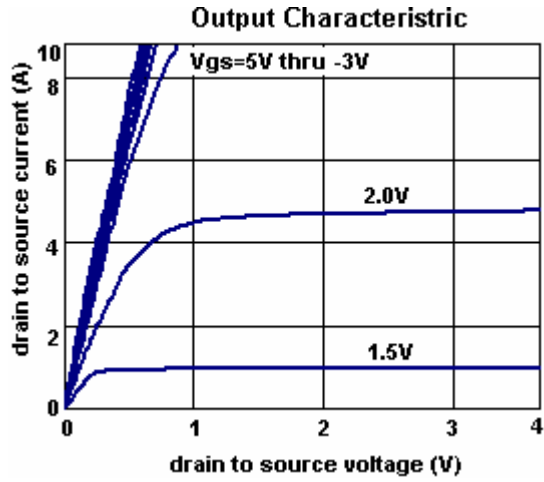

Typical Characteristics Curve (Ta = 25 °C unless otherwise noted)

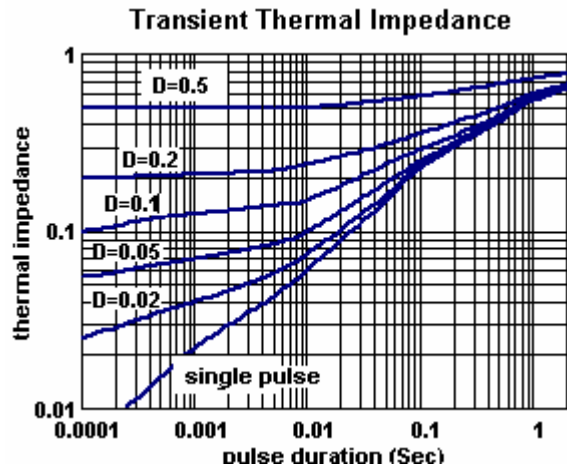
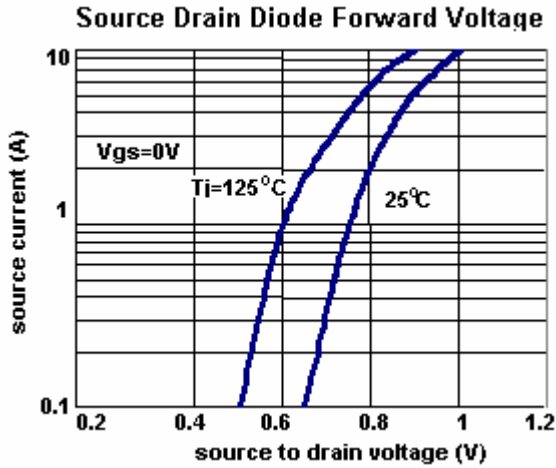

SOT-23 Mechanical Drawing

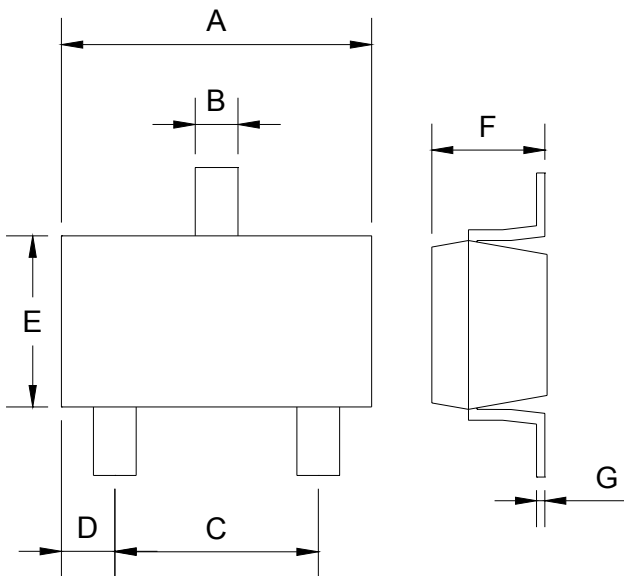

SOT-23 DIMENSION				
DIM	MILLIMETERS		INCHES	
	MIN	MAX	MIN	MAX
A	2.88	2.91	0.113	0.115
B	0.39	0.42	0.015	0.017
C	1.78	2.03	0.070	0.080
D	0.51	0.61	0.020	0.024
E	1.59	1.66	0.063	0.065
F	1.04	1.08	0.041	0.043
G	0.07	0.09	0.003	0.004