

Q1:TOSHIBA FIELD EFFECT TRANSISTOR SILICON N CHANNEL MOS TYPE(U—MOSⅢ)
 Q2:TOSHIBA INCLUDES SCHOTTKY BARRIER DIODE FIELD EFFECT TRANSISTOR SILICON
 N CHANNEL MOS TYPE(U—MOSⅢ)

TPC8A01

DC-DC CONVERTER

Notebook PC

Portable Machines and Tools

- Includes Schottky Barrier Diode Type. (Q2)
 Low Forward Voltage: $V_{DSF}=0.6V(\text{Max.})$
- Small footprint due to small and thin package.
- High Speed Switching.(Q1)
- Small Gate Charge.(Q1): $Q_g=17nC(\text{Typ.})$
- Low drain-source ON resistance(Q2) $R_{DS(ON)} = 13\text{ m}\Omega$ (typ.)
- High forward transfer admittance(Q2): $|Y_{fs}| = 11\text{ S}$ (typ.)
- Low leakage current. (Q1): $I_{DSS} = 10\text{ }\mu\text{A}(\text{Max.})$ ($V_{DS} = 30\text{ V}$)
 (Q2): $I_{DSS} = 100\text{ }\mu\text{A}(\text{Max.})$ ($V_{DS} = 30\text{ V}$)
- Enhancement-mode
 : (Q1) $V_{th} = 1.1\sim 2.3\text{ V}$ ($V_{DS} = 10\text{ V}$, $I_D = 1\text{ mA}$)
 : (Q2) $V_{th} = 1.1\sim 2.3\text{ V}$ ($V_{DS} = 10\text{ V}$, $I_D = 1\text{ mA}$)

Absolute Maximum Ratings ($T_a = 25^\circ\text{C}$)

Characteristics		Symbol	Rating		Unit
			Q1	Q2	
Drain-source voltage		V_{DSS}	30	30	V
Drain-gate voltage ($R_{GS} = 20\text{ k}\Omega$)		V_{DGR}	30	30	V
Gate-source voltage		V_{GSS}	± 20	± 20	V
Drain current	DC (Note 1)	I_D	6	8.5	A
	Pulse (Note 1)	I_{DP}	24	34	
Drain power dissipation ($t = 10\text{ s}$) (Note 2a)	Single-device operation (Note 3a)	$P_{D(1)}$	1.5		W
	Single-device value at dual operation (Note 3b)	$P_{D(2)}$	1.1		
Drain power dissipation ($t = 10\text{ s}$) (Note 2b)	Single-device operation (Note 3a)	$P_{D(1)}$	0.75		
	Single-device value at dual operation (Note 3b)	$P_{D(2)}$	0.45		
Single pulse avalanche energy		E_{AS}	46.8 (Note 4a)	93.9 (Note 4b)	mJ
Avalanche current		I_{AR}	6	8.5	A
Repetitive avalanche energy Single-device value at operation (Note 2a, 3b, 5)		E_{AR}	0.11		mJ
Channel temperature		T_{ch}	150		$^\circ\text{C}$
Storage temperature range		T_{stg}	-55~150		$^\circ\text{C}$

Note: (Note 1), (Note 2ab), (Note 3ab), (Note 4), (Note 5) Please see next page.

Using continuously under heavy loads (e.g. the application of high temperature/current/voltage and the significant change in temperature, etc.) may cause this product to decrease in the reliability significantly even if the operating conditions (i.e. operating temperature/current/voltage, etc.) are within the absolute maximum ratings. Please design the appropriate reliability upon reviewing the Toshiba Semiconductor Reliability Handbook ("Handling Precautions"/Derating Concept and Methods) and individual reliability data (i.e. reliability test report and estimated failure rate, etc).

This transistor is an electrostatic sensitive device. Please handle with caution.

Schottky barrier diodes are having large-reverse-current-leakage characteristic compare to the other rectifier products. This current leakage and not proper operating temprature or vottage may cause thermalrun. Please take forward and reverse loss into consideration when you design.

Unit: mm

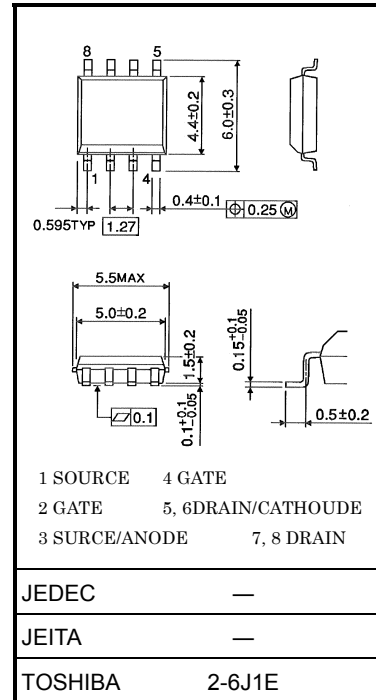

Weight: 0.080 g (typ.)

Circuit Configuration

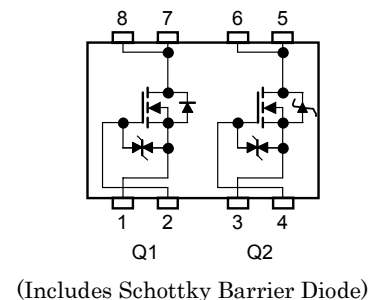

Thermal Characteristics

Characteristics		Symbol	Max	Unit
Thermal resistance, channel to ambient (t = 10s) (Note 2a)	Single-device operation (Note 3a)	$R_{th(ch-a)}(1)$	83.3	°C/W
	Single-device value at dual operation (Note 3b)	$R_{th(ch-a)}(2)$	114	
Thermal resistance, channel to ambient (t = 10s) (Note 2b)	Single-device operation (Note 2a)	$R_{th(ch-a)}(1)$	167	
	Single-device value at dual operation (Note 2b)	$R_{th(ch-a)}(2)$	278	

Marking

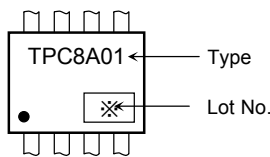

Note 1: Please use devices on condition that the channel temperature is below 150°C.

Note 2:

- a) Device mounted on a glass-epoxy board (a) b) Device mounted on a glass-epoxy board (b)

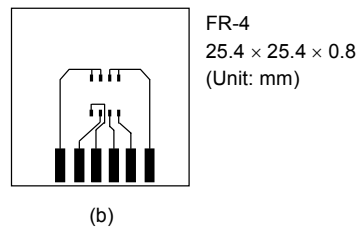
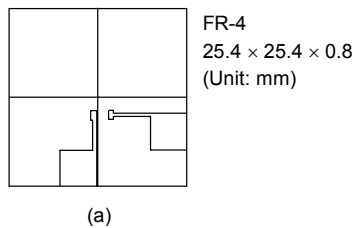

Note 3:

- a) The power dissipation and thermal resistance values are shown for a single device (During single-device operation, power is only applied to one device.)
- b) The power dissipation and thermal resistance values are shown for a single device (During dual operation, power is evenly applied to both devices.)

Note 4:

- a) $V_{DD} = 24\text{ V}$, $T_{ch} = 25^\circ\text{C}$ (Initial), $L = 1.0\text{ mH}$, $R_G = 25\ \Omega$, $I_{AR} = 6.0\text{ A}$
- b) $V_{DD} = 24\text{ V}$, $T_{ch} = 25^\circ\text{C}$ (Initial), $L = 1.0\text{ mH}$, $R_G = 25\ \Omega$, $I_{AR} = 8.5\text{ A}$

Note 5: Repetitive rating; pulse width limited by max channel temperature.

Note 6: • on lower left of the marking indicates Pin 1.

※ Weekly code: (Three digits)

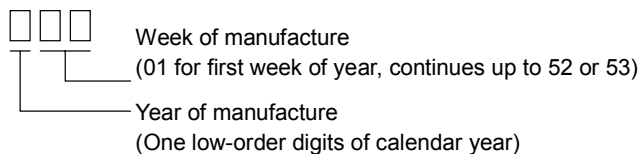

Q1

Electrical Characteristics (Ta = 25°C)

Characteristics		Symbol	Test Condition	Min	Typ.	Max	Unit
Gate leakage current		I_{GSS}	$V_{GS} = \pm 16 \text{ V}, V_{DS} = 0 \text{ V}$	—	—	± 10	μA
Drain cut-OFF current		I_{DSS}	$V_{DS} = 30 \text{ V}, V_{GS} = 0 \text{ V}$	—	—	-10	μA
Drain-source breakdown voltage		$V_{(BR)DSS}$	$I_D = 10 \text{ mA}, V_{GS} = 0 \text{ V}$	30	—	—	V
		$V_{(BR)DSX}$	$I_D = 10 \text{ mA}, V_{GS} = -20 \text{ V}$	15	—	—	
Gate threshold voltage		V_{th}	$V_{DS} = 10 \text{ V}, I_D = 1 \text{ mA}$	1.1	—	2.3	V
Drain-source ON resistance		$R_{DS(ON)}$	$V_{GS} = 4.5 \text{ V}, I_D = 3.0 \text{ A}$	—	23	30	$\text{m}\Omega$
			$V_{GS} = 10 \text{ V}, I_D = 3.0 \text{ A}$	—	18	25	
Forward transfer admittance		$ Y_{fs} $	$V_{DS} = 10 \text{ V}, I_D = 3.0 \text{ A}$	4.5	9	—	S
Input capacitance		C_{iss}	$V_{DS} = 10 \text{ V}, V_{GS} = 0 \text{ V}, f = 1 \text{ MHz}$	—	940	—	pF
Reverse transfer capacitance		C_{rss}		—	130	—	
Output capacitance		C_{oss}		—	390	—	
Switching time	Rise time	t_r		—	17	—	ns
	Turn-ON time	t_{on}		—	25	—	
	Fall time	t_f		—	4	—	
	Turn-OFF time	t_{off}		Duty $\leq 1\%$, $t_w = 10 \mu\text{s}$	—	21	
Total gate charge (gate-source plus gate-drain)		Q_g	$V_{DD} \approx 24 \text{ V}, V_{GS} = 10 \text{ V}, I_D = 6.0 \text{ A}$	—	17	—	nC
			$V_{DD} \approx 24 \text{ V}, V_{GS} = 5 \text{ V}, I_D = 6.0 \text{ A}$	—	10	—	
Gate-source charge 1		Q_{gs1}	$V_{DD} \approx 24 \text{ V}, V_{GS} = 10 \text{ V}, I_D = 6.0 \text{ A}$	—	1.9	—	
Gate-drain ("miller") charge		Q_{gd}		—	4.1	—	
Gateswitch charge		Q_{sw}		—	6	—	

Source-Drain Ratings and Characteristics (Ta = 25°C)

Characteristics		Symbol	Test Condition	Min	Typ.	Max	Unit
Drain reverse current	Pulse (Note 1)	I_{DRP}	—	—	—	24	A
Forward voltage (diode)		V_{DSF}	$I_{DR} = 6.0 \text{ A}, V_{GS} = 0 \text{ V}$	—	—	-1.2	V

Q2 (Includes Schottky Barrier Diode)

Electrical Characteristics (Ta = 25°C)

Characteristics		Symbol	Test Condition	Min	Typ.	Max	Unit
Gate leakage current		I_{GSS}	$V_{GS} = \pm 16\text{ V}, V_{DS} = 0\text{ V}$	—	—	± 10	μA
Drain cut-OFF current		I_{DSS}	$V_{DS} = 30\text{ V}, V_{GS} = 0\text{ V}$	—	—	10	μA
Drain-source breakdown voltage		$V_{(BR)DSS}$	$I_D = 10\text{ mA}, V_{GS} = 0\text{ V}$	30	—	—	V
		$V_{(BR)DSX}$	$I_D = 10\text{ mA}, V_{GS} = -20\text{ V}$	15	—	—	
Gate threshold voltage		V_{th}	$V_{DS} = 10\text{ V}, I_D = 1\text{ mA}$	1.1	—	2.3	V
Drain-source ON resistance		$R_{DS(ON)}$	$V_{GS} = 4.5\text{ V}, I_D = 4.3\text{ A}$	—	16	21	$\text{m}\Omega$
			$V_{GS} = 10\text{ V}, I_D = 4.3\text{ A}$	—	13	18	
Forward transfer admittance		$ Y_{fs} $	$V_{DS} = 10\text{ V}, I_D = 4.3\text{ A}$	5.5	11	—	S
Input capacitance		C_{iss}	$V_{DS} = 10\text{ V}, V_{GS} = 0\text{ V}, f = 1\text{ MHz}$	—	2295	—	pF
Reverse transfer capacitance		C_{rss}		—	360	—	
Output capacitance		C_{oss}		—	510	—	
Switching time	Rise time	t_r	<p>$V_{GS} = 10\text{ V}$ 0 V $I_D = 4.3\text{ A}$ $R_L = 3.5\ \Omega$ $V_{DD} \approx 15\text{ V}$</p>	—	8	—	ns
	Turn-ON time	t_{on}		—	17	—	
	Fall time	t_f		—	15	—	
	Turn-OFF time	t_{off}		Duty $\leq 1\%$, $t_w = 10\ \mu\text{s}$	—	52	
Total gate charge (gate-source plus gate-drain)		Q_g	$V_{DD} \approx 24\text{ V}, V_{GS} = 10\text{ V}, I_D = 8.5\text{ A}$	—	49	—	nC
			$V_{DD} \approx 24\text{ V}, V_{GS} = 5\text{ V}, I_D = 8.5\text{ A}$	—	27	—	
Gate-source charge 1		Q_{gs1}	$V_{DD} \approx 24\text{ V}, V_{GS} = 10\text{ V}, I_D = 8.5\text{ A}$	—	3.7	—	
Gate-drain ("miller") charge		Q_{gd}		—	10.8	—	
Gateswitch charge		Q_{sw}		—	14.5	—	

Source-Drain Ratings and Characteristics (Ta = 25°C)

Characteristics		Symbol	Test Condition	Min	Typ.	Max	Unit
Drain reverse current	Pulse (Note 1)	I_{DRP}	—	—	—	34	A
Forward voltage (diode)		V_{DSF}	$I_{DR} = 1.0\text{ A}, V_{GS} = 0\text{ V}$	—	-0.5	-0.6	V
			$I_{DR} = 8.5\text{ A}, V_{GS} = 0\text{ V}$	—	—	-1.2	

Q1

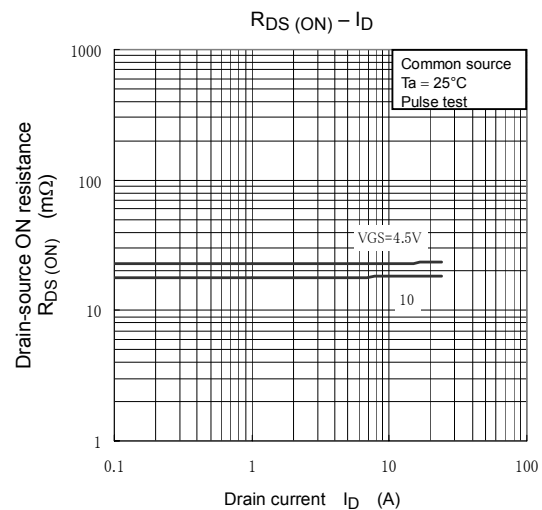
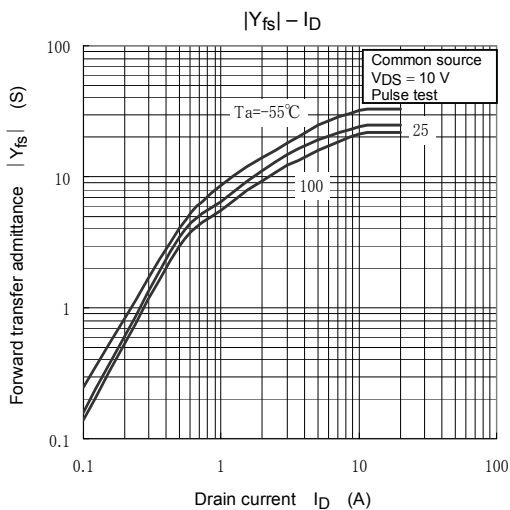
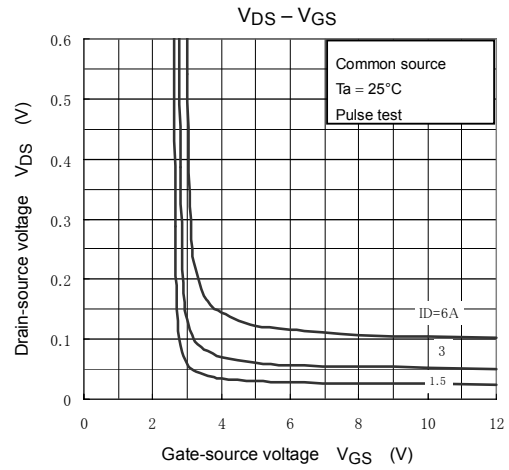
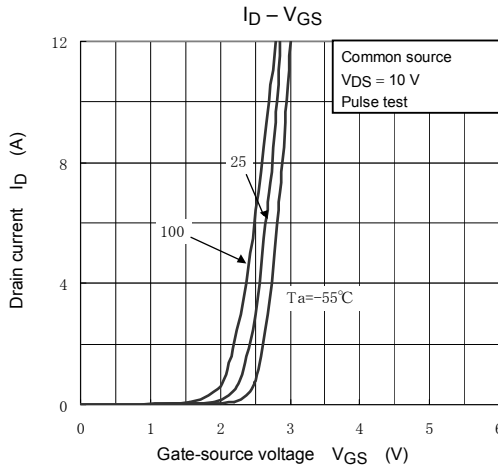
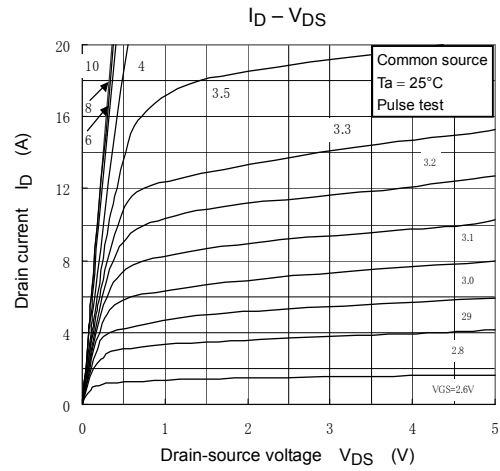
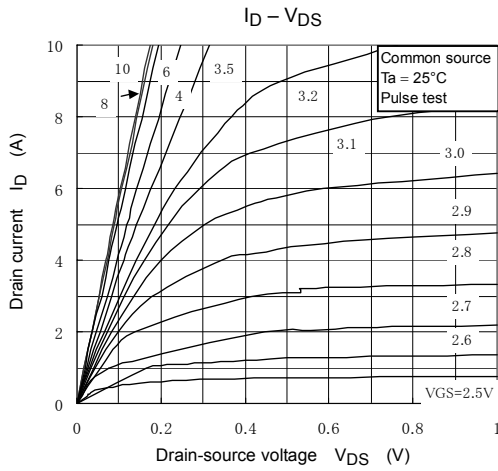

Q1

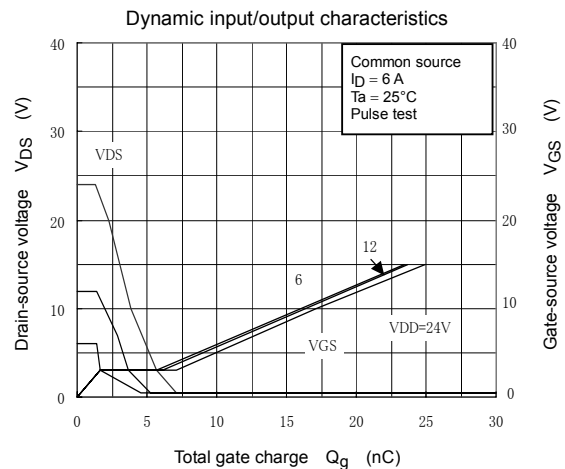
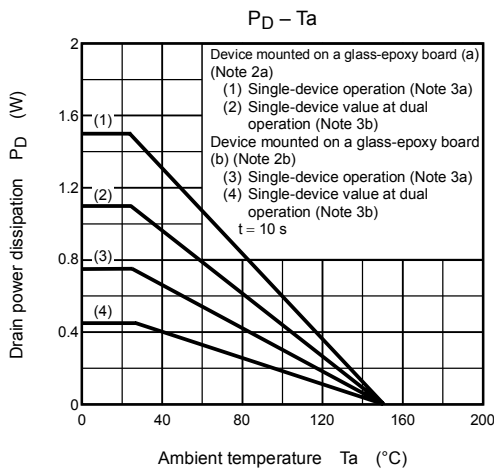
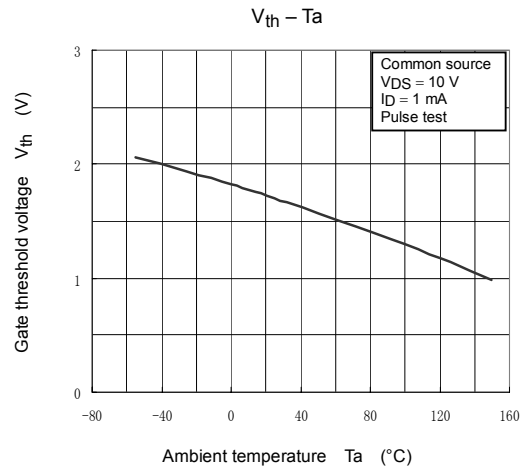
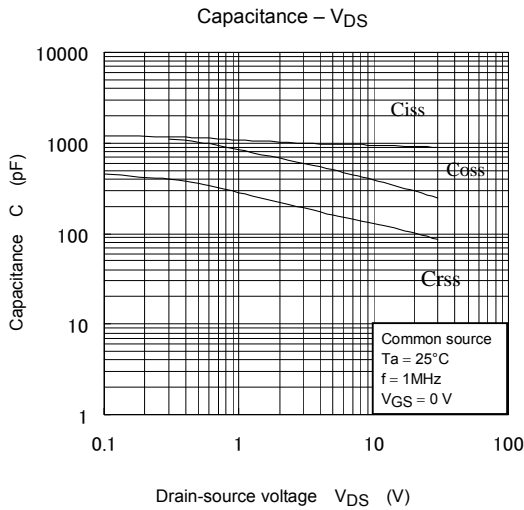
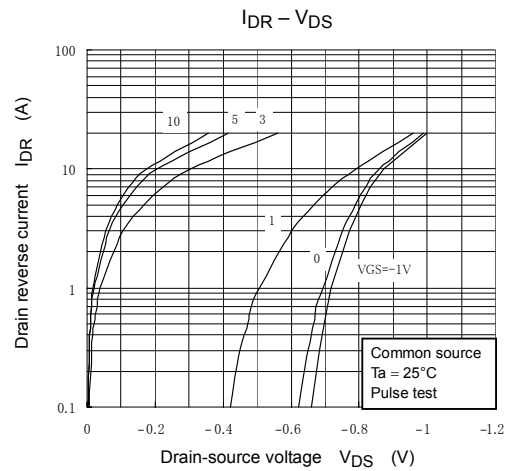
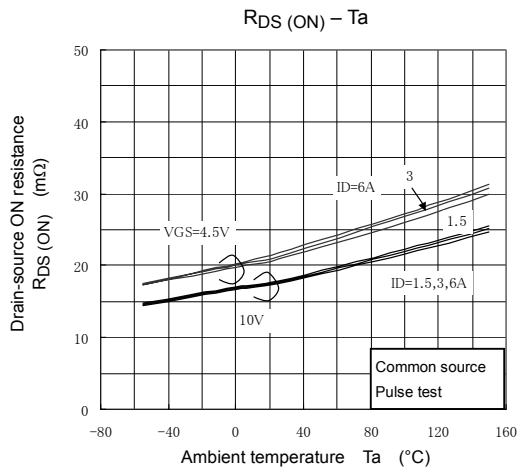

Q1

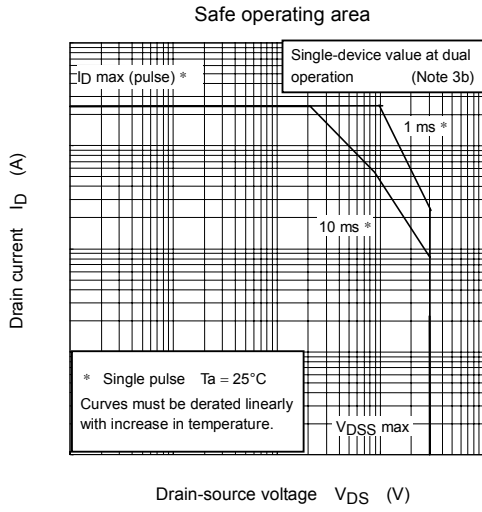
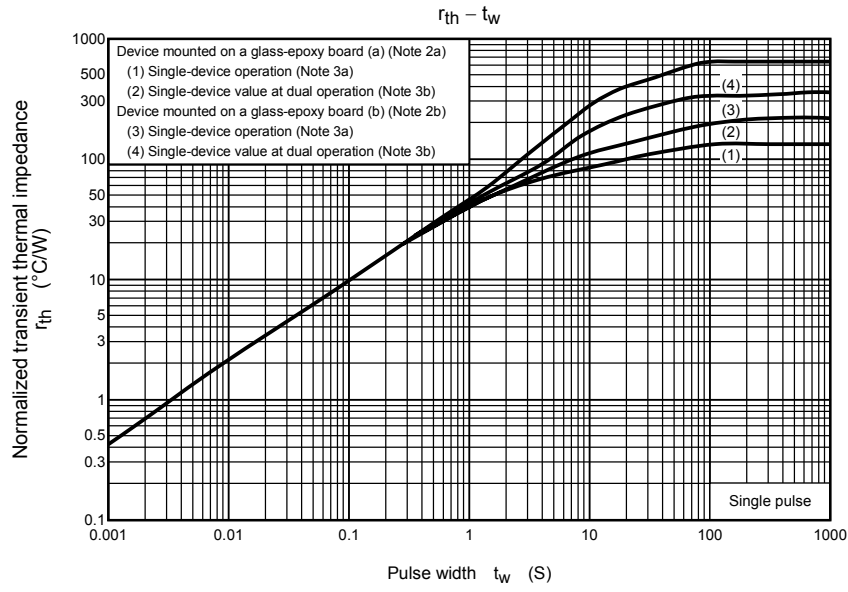

Q2(Includes Schottky Barrier Diode)

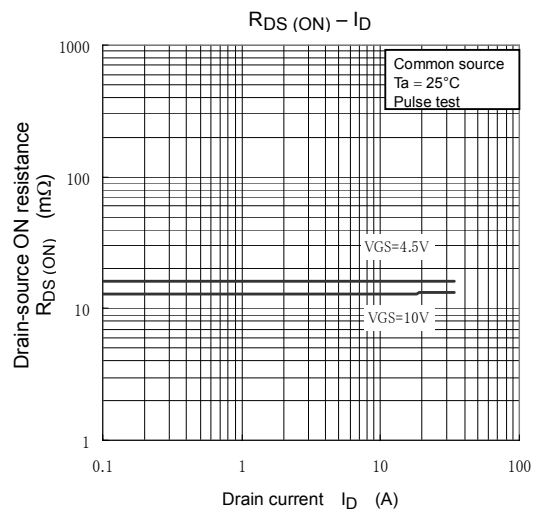
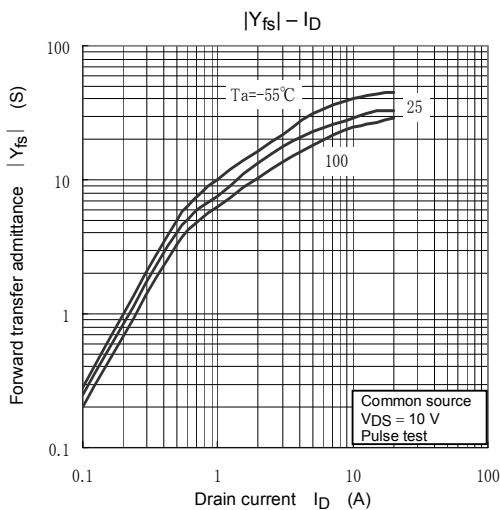
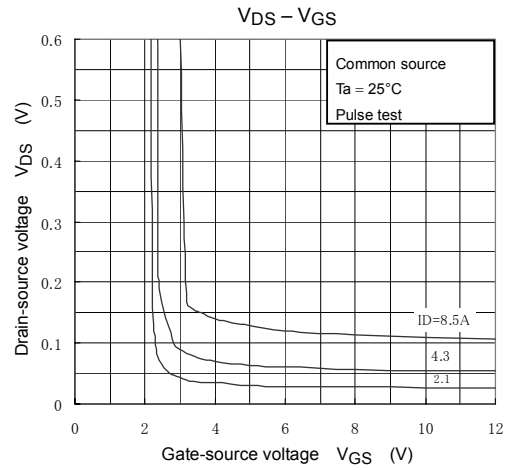
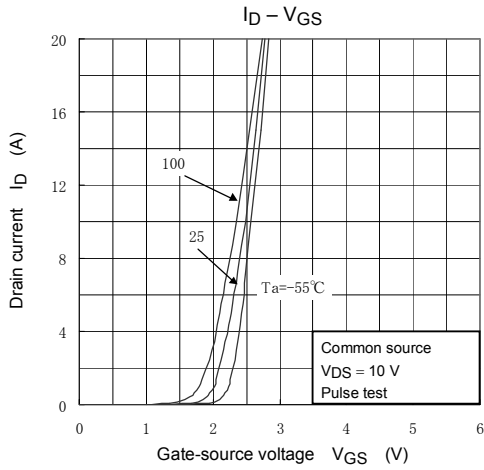
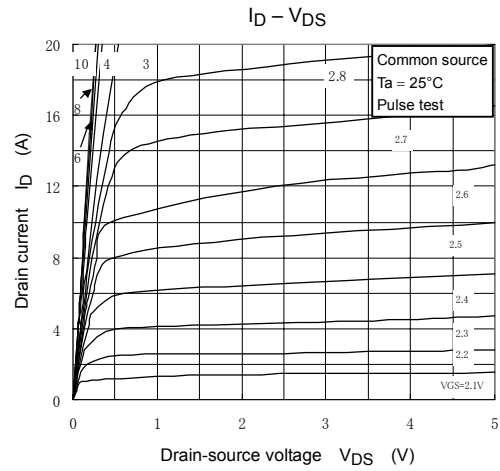
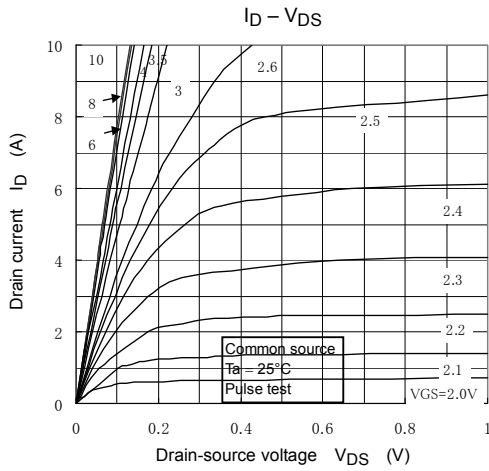

Q2(Includes Schottky Barrier Diode)

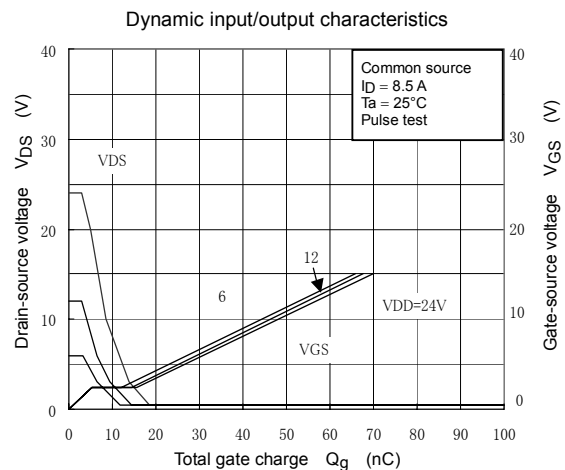
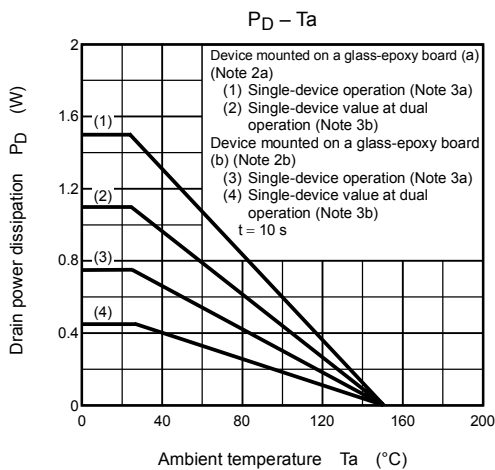
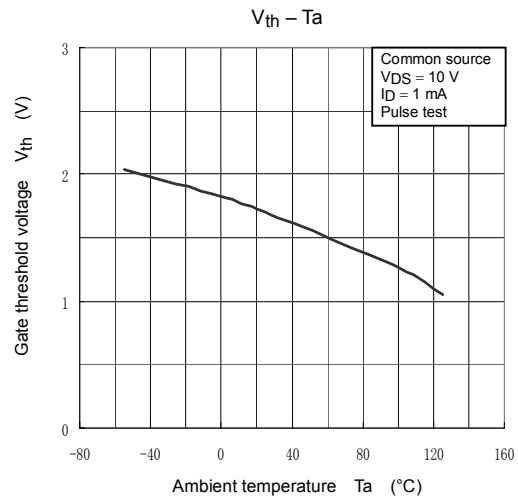
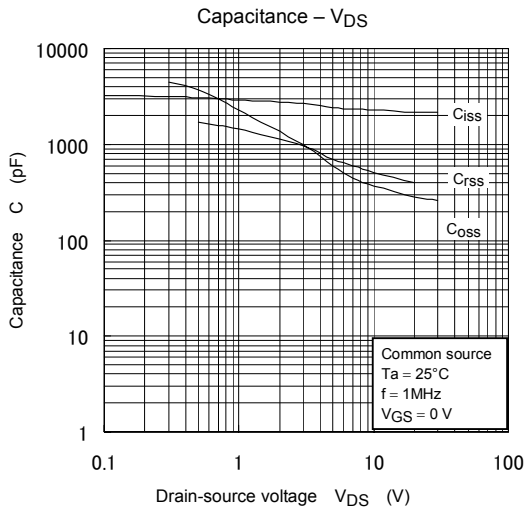
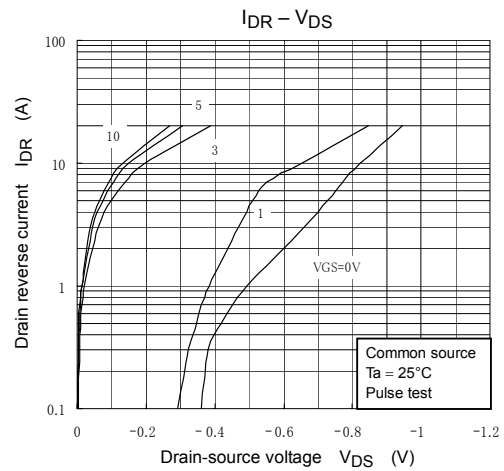
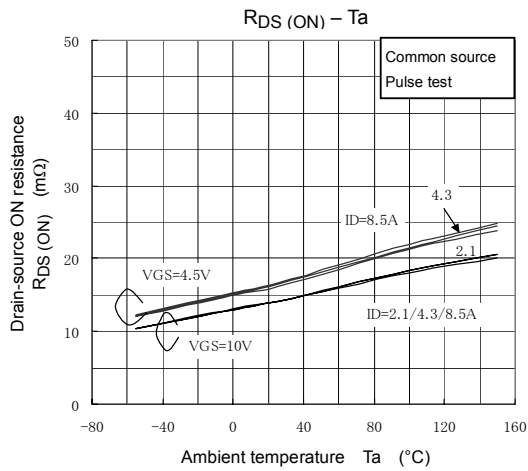

Q2(Includes Schottky Barrier Diode)

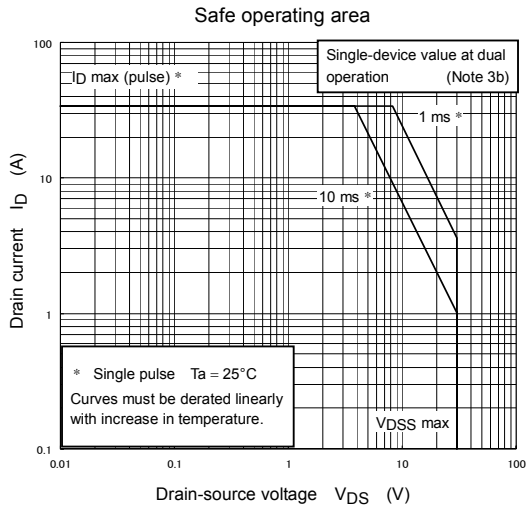
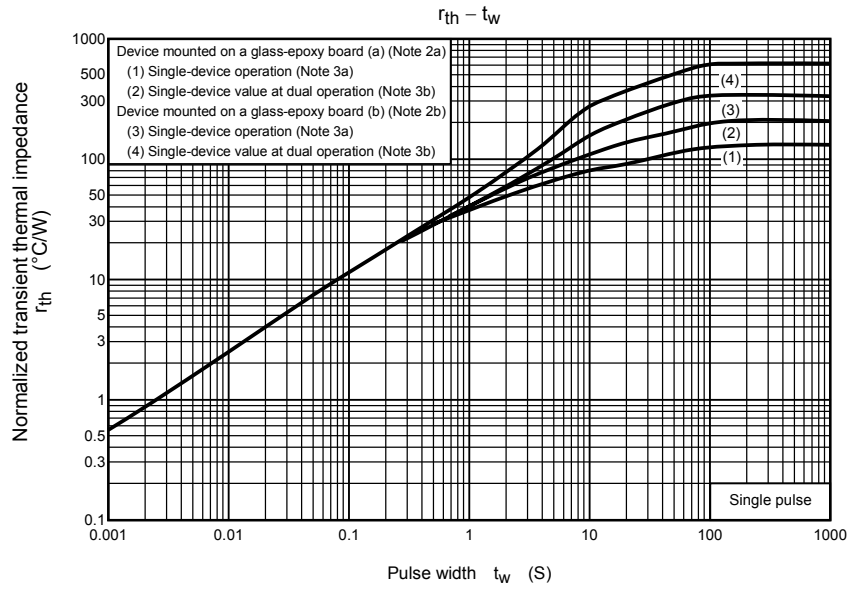

Q2 ($V_{GS}=0V$)

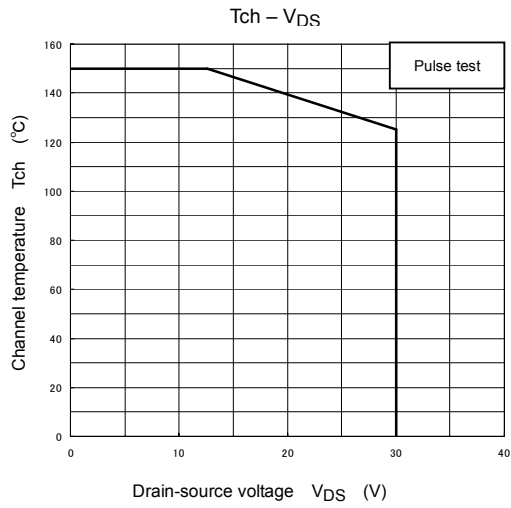
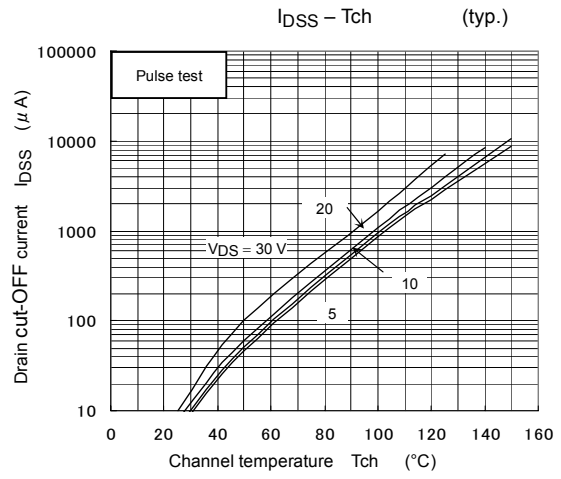
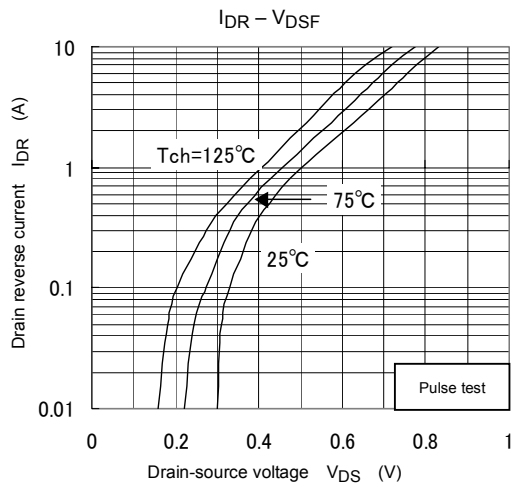

RESTRICTIONS ON PRODUCT USE

030619EAA

- The information contained herein is subject to change without notice.
- The information contained herein is presented only as a guide for the applications of our products. No responsibility is assumed by TOSHIBA for any infringements of patents or other rights of the third parties which may result from its use. No license is granted by implication or otherwise under any patent or patent rights of TOSHIBA or others.
- TOSHIBA is continually working to improve the quality and reliability of its products. Nevertheless, semiconductor devices in general can malfunction or fail due to their inherent electrical sensitivity and vulnerability to physical stress. It is the responsibility of the buyer, when utilizing TOSHIBA products, to comply with the standards of safety in making a safe design for the entire system, and to avoid situations in which a malfunction or failure of such TOSHIBA products could cause loss of human life, bodily injury or damage to property.
In developing your designs, please ensure that TOSHIBA products are used within specified operating ranges as set forth in the most recent TOSHIBA products specifications. Also, please keep in mind the precautions and conditions set forth in the "Handling Guide for Semiconductor Devices," or "TOSHIBA Semiconductor Reliability Handbook" etc..
- The TOSHIBA products listed in this document are intended for usage in general electronics applications (computer, personal equipment, office equipment, measuring equipment, industrial robotics, domestic appliances, etc.). These TOSHIBA products are neither intended nor warranted for usage in equipment that requires extraordinarily high quality and/or reliability or a malfunction or failure of which may cause loss of human life or bodily injury ("Unintended Usage"). Unintended Usage include atomic energy control instruments, airplane or spaceship instruments, transportation instruments, traffic signal instruments, combustion control instruments, medical instruments, all types of safety devices, etc.. Unintended Usage of TOSHIBA products listed in this document shall be made at the customer's own risk.
- TOSHIBA products should not be embedded to the downstream products which are prohibited to be produced and sold, under any law and regulations.