

HS-2608

Eden Embedded Engine Board

- CompactFlash • Mini PCI • 133MHz FSB •
- SO-DIMM • CRT/LVDS Panel • Dual LAN •
- Audio • ATA/33/66/100 • RS-232/422/485 •
 - 4 COM • USB • PC/104 • DOC •
 - WDT • Single +5V • H/W Monitor •
- Industrial Embedded Single Board computer •

Copyright Disclaimers

The accuracy of contents in this manual has passed thorough checking and review before publishing. BOSER Technology Co., Ltd., the manufacturer and publisher, is not liable for any infringements of patents or other rights resulting from its use. The manufacturer will not be responsible for any direct, indirect, special, incidental or consequential damages arising from the use of this product or documentation, even if advised of the possibility of such damage(s).

This manual is copyrighted and BOSER Technology Co., Ltd. reserves all documentation rights. Unauthorized reproduction, transmission, translation, and storage of any form and means (i.e., electronic, mechanical, photocopying, recording) of this document, in whole or partly, is prohibited, unless granted permission by BOSER Technology Co., Ltd.

BOSER Technology Co., Ltd. reserves the right to change or improve the contents of this document without due notice. BOSER Technology Co., Ltd. assumes no responsibility for any errors or omissions that may appear in this manual, nor does it make any commitment to update the information contained herein.

Trademarks

BOSER is a registered trademark of BOSER Technology Co., Ltd.

ISB is a registered trademark of BOSER Technology Co., Ltd.

VIA is a registered trademark of VIA Technologies, Inc.

Award is a registered trademark of Award Software, Inc.

AMI is a registered trademark of AMI Software, Inc.

All other trademarks, products and or product names mentioned herein are mentioned for identification purposes only, and may be trademarks and/or registered trademarks of their respective companies or owners.



**© Copyright 2005 BOSER Technology Co., Ltd.
All Rights Reserved.
Edition 1.0, August 19, 2005**

Table of Contents

Chapter 1	General Description	1
1.1	Major Features	2
1.2	Specifications	3
1.3	Board Dimensions	4
Chapter 2	Unpacking	5
2.1	Opening the Delivery Package	5
2.2	Inspection	5
Chapter 3	Hardware Installation	7
3.1	Before Installation	7
3.2	Board Layout	8
3.3	Jumper List	9
3.4	Connector List	9
3.5	Configuring the CPU	10
3.6	System Memory	10
3.7	DiskOnChip™ Address Setting	10
3.8	VGA Controller	12
3.9	PCI E-IDE Drive Connector	14
3.10	Floppy Disk Drive Connector	15
3.11	Serial Port Connectors	16
3.12	Parallel Connector	18
3.13	Ethernet Connector	19
3.14	USB Connector	19
3.15	CMOS Data Clear	19
3.16	Power and Fan Connectors	20
3.17	Keyboard/Mouse Connectors	20
3.18	System Front Panel Connectors	21
3.19	Watchdog Timer	22
3.20	Mini PCI Connector	24
3.21	PC/104 Connectors	26
3.22	Audio Connectors	28
3.23	CompactFlash™ Connector	28

Chapter 4	Award BIOS Setup	31
4.1	Starting Setup.....	31
4.2	Using Setup	32
4.2.1	Getting Help.....	32
4.3	Main Menu	33
4.4	Standard CMOS Features.....	34
4.5	Advanced BIOS Features	35
4.6	Advanced Chipset Features	36
4.7	Integrated Peripherals	37
4.8	Power Management Setup	38
4.9	PnP/PCI Configurations.....	39
4.10	PC Health Status	40
4.11	Frequency/Voltage Control	40
4.12	Load Fail-Safe Defaults	41
4.13	Load Optimized Defaults	42
4.14	Set Supervisor/User Password.....	42
4.15	Save & Exit Setup.....	44
4.16	Exit Without Saving.....	45
Chapter 5	Software Utilities	47
5.1	IDE Driver Installation	47
5.2	VGA Driver Installation	52
5.2.1	VGA Driver Installation for WIN95/98/2K.....	52
5.2.2	VGA Driver Installation for WIN NT4.0	55
5.3	LAN Driver Installation.....	58
5.3.1	LAN Driver Installation for WIN95/98/2K.....	58
5.3.2	LAN Driver Installation for WIN NT4.0	64
5.4	Audio Driver Installation.....	74

Safety Instructions

Integrated circuits on computer boards are sensitive to static electricity. To avoid damaging chips from electrostatic discharge, observe the following precautions:

- Do not remove boards or integrated circuits from their anti-static packaging until you are ready to install them.
- Before handling a board or integrated circuit, touch an unpainted portion of the system unit chassis for a few seconds. This helps to discharge any static electricity on your body.
- Wear a wrist-grounding strap, available from most electronic component stores, when handling boards and components. Fasten the ALLIGATOR clip of the strap to the end of the shielded wire lead from a grounded object. Please wear and connect the strap before handle the HS-2608 to ensure harmlessly discharge any static electricity through the strap.
- Please use an anti-static pad when putting down any components or parts or tools outside the computer. You may also use an anti-static bag instead of the pad. Please inquire from your local supplier for additional assistance in finding the necessary anti-static gadgets.

NOTE: *DO NOT TOUCH THE BOARD OR ANY OTHER SENSITIVE COMPONENTS WITHOUT ALL NECESSARY ANTI-STATIC PROTECTIONS.*

Chapter 1

General Description



The HS-2608 is a 100/133MHz FSB VIA VT8606 chipset-based board designed for Mini PCI Local Bus VIA Eden 667MHz embedded low power CPU. These features combine and make the HS-2608 an ideal all-in-one industrial single board computer. Additional features include an enhanced I/O with CRT/LVDS Panel, dual LAN, Audio, and 4 COM ports interfaces.

Its onboard ATA/33/66/100 to IDE drive interface architecture allows the HS-2608 to support data transfers of 33, 66 or 100MB/sec. to one IDE drive connection. Designed with the VIA VT8606 core logic chipset, the board supports VIA Eden 667MHz embedded low power CPU.

The VIA VT8606 with 32MB shared main memory supporting CRT/Panel displays up to 1280 x 1024 at 24bpp colors (CRT)/1024 x 768 at 18bpp colors (Panel). It also supports 18-bit dual channel LVDS interface.

System memory is also sufficient with the one SO-DIMM socket that can support up to 512MB.

Additional onboard connectors include an advanced USB port providing faster data transmission, a DOS-compatible DiskOnChip™ socket with a maximum capacity of 288MB. And two external RJ-45 connectors for 10/100 Based Ethernet use.

To ensure the reliability in an unmanned or standalone system, the Watchdog Timer (WDT) onboard HS-2608 is designed with pure hardware that does not need the arithmetical functions of a real-time clock chip. If any program causes unexpected halts to the system, the onboard Watchdog Timer (WDT) will automatically reset the CPU or generate an interrupt to resolve such condition.

1.1 Major Features

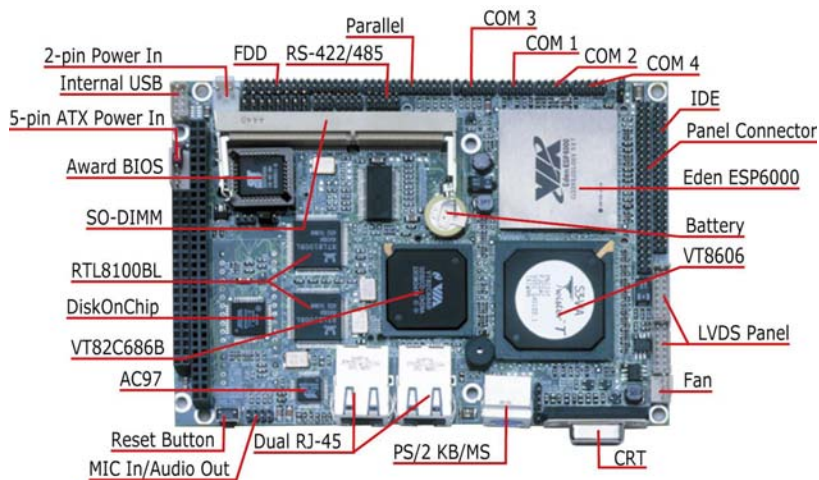

The HS-2608 comes with the following features:

- VIA Eden 667MHz embedded low power CPU
- Supports 100/133MHz FSB
- One SO-DIMM socket with a max. capacity of 512MB
- VIA VT8606/VT82C686B system chipset
- VIA VT82C686B, SMC 37C669 super I/O chipset
- VIA VT8606 display controller
- Dual RealTek RTL8100BL LAN controller
- AC97 3D audio controller
- Fast PCI ATA/33/66/100 IDE controller
- CompactFlash card adapter, four COM, two USB, PC/104 connector
- DOC socket supporting memory sizes of up to 288MB
- Single +5V power in
- Hardware Monitor function
- LVDS Panel display interface (optional)

1.2 Specifications

- **CPU:** VIA Eden 667MHz embedded low power CPU
- **Memory:** One SO-DIMM socket supporting up to 512MB
- **Chipset:** VIA VT8606/VT82C686B
- **I/O Chipset:** VIA VT82C686B, SMC 37C669
- **CompactFlash:** One, Type II IDE interface adapter
- **PCI Slot:** One, Type I mini PCI slot (optional)
- **VGA:** VIA VT8606 with 32MB shared main memory supporting CRT/Panel displays up to 1280 x 1024 at 24bpp colors (CRT)/1024 x 768 at 18bpp colors (Panel)
- **LVDS Panel:** Supports 18-bit dual channel LVDS interface (optional)
- **LAN:** Dual RealTek RTL8100BL 10/100 Based LAN
- **Audio:** AC97 3D audio controller
- **IDE:** Two IDE disk drives supporting ATA/33/66/100 and with transfer rates of up to 33/66/100MB/sec.
- **FDD:** Supports up to two floppy disk drives
- **Parallel:** One enhanced bi-directional parallel port supporting SPP/ECP/EPP
- **Serial Port:** 16C550 UART-compatible RS-232/422/485 x 1 and RS-232 x 3 serial ports with 16-byte FIFO
- **USB:** Two internal USB ports
- **PC/104:** PC/104 Bus connector for 16-bit ISA Bus
- **Keyboard/Mouse:** PS/2 6-pin Mini DIN or 6-pin header
- **DiskOnChip™:** DiskOnChip™ socket supporting memory sizes of up to 288MB
- **BIOS:** Award PnP Flash BIOS
- **Watchdog Timer:** Sets 1/2/10/20/110/220 seconds activity trigger with Reset or NMI
- **CMOS:** Battery backup
- **Power In:** Single +5V power in
- **Temperature:** 0~+60°C (operating)
- **Hardware Monitor:** VIA VT82C686B
- **Board Size:** 14.5(L) x 10.2(W) cm

1.3 Board Dimensions

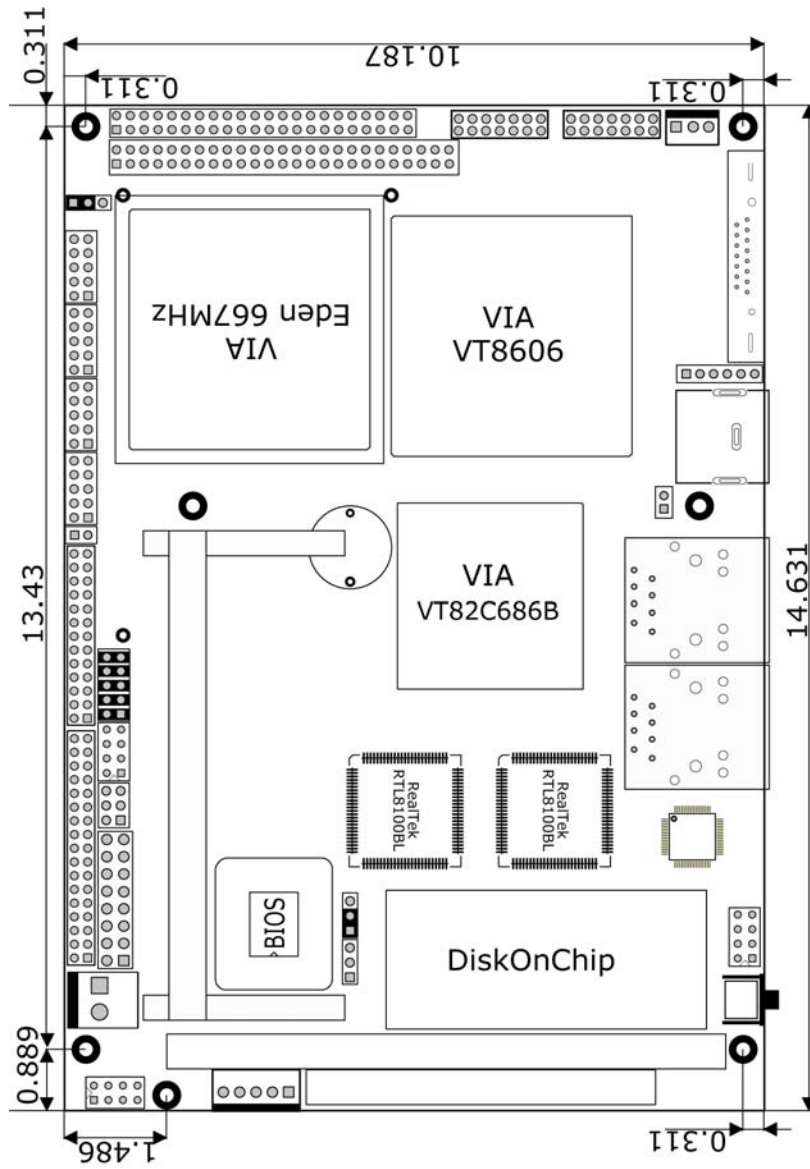

Chapter 2

Unpacking

2.1 Opening the Delivery Package

The HS-2608 is packed in an anti-static bag. The board has components that are easily damaged by static electricity. Do not remove the anti-static wrapping until proper precautions have been taken. Safety Instructions in front of this manual describe anti-static precautions and procedures.

2.2 Inspection

After unpacking the board, place it on a raised surface and carefully inspect the board for any damage that might have occurred during shipment. Ground the board and exercise extreme care to prevent damage to the board from static electricity.

Integrated circuits will sometimes come out of their sockets during shipment. Examine all integrated circuits, particularly the BIOS, processor, memory modules, ROM-Disk, and keyboard controller chip to ensure that they are firmly seated. The HS-2608 delivery package contains the following items:

- HS-2608 Board x 1
- Utility CD Disk x 1
- Cables Package x 1
- Cooling Fan & Heat Sink x 1
- Jumper Bag x 1
- User's Manual

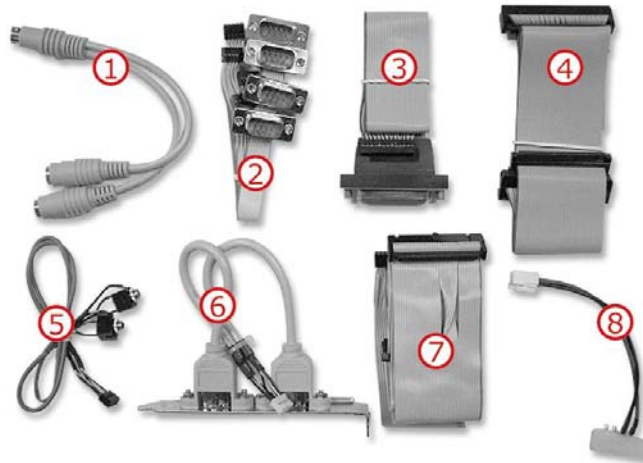

Cables Package	
NO.	Description
1	Keyboard/Mouse transfer cable x 1
2	One COM flat cable x 4
3	Parallel port flat cable x 1
4	ATA/100 IDE flat cable x 1
5	MIC/Audio flat cable x 1
6	Two USB flat cable with bracket x 1
7	Floppy flat cable x 1
8	4-pin Power In cable x 1

It is recommended that you keep all the parts of the delivery package intact and store them in a safe/dry place for any unforeseen event requiring the return shipment of the product. In case you discover any missing and/or damaged items from the list of items, please contact your dealer immediately.

Chapter 3

Hardware Installation

This chapter provides the information on how to install the hardware using the HS-2608. This chapter also contains information related to jumper settings of switch, watchdog timer, and the DiskOnChip™ address selection etc.

3.1 Before Installation

After confirming your package contents, you are now ready to install your hardware. The following are important reminders and steps to take before you begin with your installation process.

1. Make sure that all jumper settings match their default settings and CMOS setup correctly. Refer to the sections on this chapter for the default settings of each jumper.
2. Go through the connections of all external devices and make sure that they are installed properly and configured correctly within the CMOS setup. Refer to the sections on this chapter for the detailed information on the connectors.
3. Keep the manual and diskette in good condition for future reference and use.

3.2 Board Layout

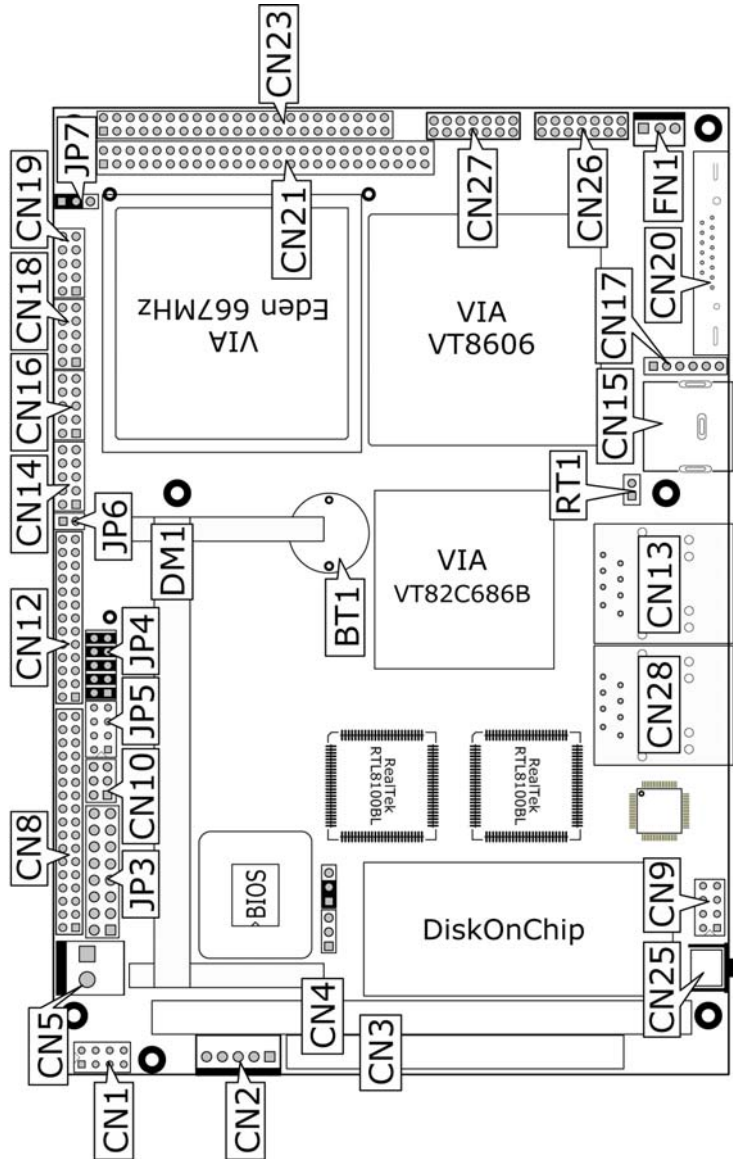

3.3 Jumper List

Jumper	Default Setting	Setting	Page
JP1	WDT Active Type Setting: <i>Disabled</i>	All Open	22
JP2	Clear CMOS: <i>Normal Operation</i>	Short 1-2	19
JP4(1-4)	DOC Address Select: <i>D000</i>	Short 1-2, 3-4	10
JP4(5-10)	WDT Timer Select: <i>1sec.</i>	Short 5-6, 7-8, 9-10	22
JP5(7-8)	RS-422/485 Receiver Enabled/Disabled Select: <i>Disabled</i>	Open	16
JP6	COM2 Use RS-232 or RS-422/485 Select: <i>RS-232</i>	Open	16
JP7	Panel Voltage Select: <i>+3.3V</i>	Short 1-2	12

3.4 Connector List

Connector	Definition	Page
CN1	USB Connector	19
CN2	5-pin ATX Power In Connector	20
CN3/CN4	PC/104 40-pin/64-pin Connector	26
CN5	2-pin Power In Connector	20
CN8	Floppy Connector	15
CN9	Line In/Audio Out Connector	28
CN10	RS-422/485 Connector (2x3 header)	16
CN12	Parallel Connector	18
CN13/CN28	RJ-45 Connector	19
CN14	COM 3 Connector (5x2 header)	16
CN15	PS/2 6-pin Mini DIN KB/MS Connector	20
CN16	COM 1 Connector (5x2 header)	16
CN17	6-pin KB/MS Connector	20
CN18	COM 2 Connector (5x2 header)	16
CN19	COM 4 Connector (5x2 header)	16
CN20	15-pin CRT Connector	12
CN21	50-pin Panel Connector	12
CN23	IDE Connector	14
CN24	CompactFlash Connector	28
CN25	External Reset Button	21
CN26/CN27	LVDS Panel Connector	12
DM1	SO-DIMM Socket	10
FN1	Fan Connector	20

... More on next page ...

Connector	Definition	Page
JP3	System Front Panel Connector	21
PC1	Mini PCI Connector	24
U1	DiskOnChip™ Socket	10

3.5 Configuring the CPU

The HS-2608 embedded with a VIA Eden 667MHz embedded low power CPU. User don't need to adjust the frequently and check speed of VIA Eden CPU.

3.6 System Memory

The HS-2608 provides one SO-DIMM socket at locations *DM1*. The maximum capacity of the onboard memory is 512MB.

3.7 DiskOnChip™ Address Setting

The DiskOnChip™ function allows the system to boot or operate without a FDD or a HDD. DiskOnChip™ modules may be formatted as drive C or A. With DiskOnChip™, user may also execute DOS commands such as FORMAT, SYS, COPY, XCOPY, DISCOPY and DISKCOMP etc.

The U1 location on the HS-2608 is the DiskOnChip™ module socket. Jumper *JP4(1-4)* assigns the starting memory address of the installed module. If you have another memory device that has a similar memory capacity with that of the DOC in your system, please set both at different memory address mapping to avoid the mapping area conflicts. Failing to do so will not make the HS-2608 and the additional memory device function properly.

- **JP4(1-4): DiskOnChip™ Address Select**

Address	PINS 1-2	PINS 3-4
D000 (default)	Short	Short
D800	Open	Short
E000	Short	Open

3.7.1 Installing DiskOnChip™ Modules

When installing a DiskOnChip™ module onto your board, please take note of the following:

1. Orient yourself properly with the location of the DiskOnChip™ socket. Try to locate the pin 1 location on your socket. Pin numbers are usually printed on either the component side or the solder side of your board.
2. Locate the Pin 1 location on your DiskOnChip™ module. More often than not, Pin 1 can be found on the lower left corner of the chip. Please refer to the diagram for the exact location.
3. Once you have figured out where the pin 1 locations are on both chip and socket, align the module's pins on an upright angle against the socket. Using both thumbs, gently press the module into the socket until all the pins are secured to their designations.

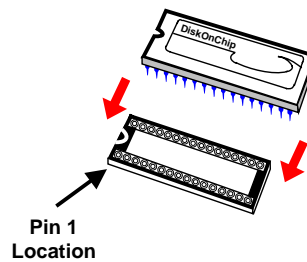

4. The installation is now complete and your module is now ready for use.

NOTE: *If you encounter difficulty installing your DiskOnChip™ module, please consult a qualified technician or engineer to perform the installation.*

3.7.2 Removing DiskOnChip™ Modules

When removing a DiskOnChip™ module from its socket, please take note of the following:

1. Loosen the contact of the module from its socket using a screwdriver.

2. Insert the screwdriver's flat head into a gap on either end of the socket. Do not insert the screwdriver head on either side where the pins are located. Doing so might damage the pins in the process.
3. Slowly lift the screwdriver handle upwards. This will disengage the module from its socket.

NOTE: *If you encounter difficulty removing your DiskOnChip™ module, please consult a qualified technician or engineer to remove it for you.*

3.8 VGA Controller

The HS-2608 provides three connection methods of a VGA device. CN20 offers a single standard CRT connector while CN21 is the 50-pin panel connector and CN26/CN27 are the LVDS interface connectors onboard reserved for flat panel installation.

- **CN20: CRT Connector**

PIN	Description	PIN	Description
1	Red	2	Green
3	Blue	4	N/C
5	GND	6	GND
7	GND	8	GND
9	N/C	10	GND
11	N/C	12	SDA
13	HSYNC	14	VSYNC
15	SCL		

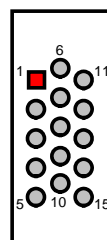

- **CN26/CN27: LVDS Interface Connector**

PIN	Description	PIN	Description
1	V _{LCD}	2	V _{LCD}
3	Y0M/Z0M	4	Y0P/Z0P
5	Y1M/Z1M	6	Y1P/Z1P
7	Y2M/Z2M	8	Y2P/Z2P
9	YCM/ZCM	10	YCP/ZCP
11	GND	12	GND

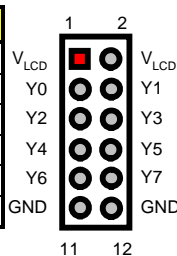

NOTE: *LVDS cable should be produced very carefully. Y0 & Y1 have to be fabricated in twister pair (Y2 & Y3, Y4 & Y5, Y6 & Y7 and so on) otherwise the signal won't be stable. Please set the proper voltage of your panel using JP7 before proceeding on installing it.*

● **CN21: 50-pin Panel Connector**

PIN.	Description	PIN	Description
1	N/C	2	N/C
3	GND	4	GND
5	V _{LCD}	6	ENAVDD
7	ENAVEE	8	GND
9	PD0	10	PD1
11	PD2	12	PD3
13	PD4	14	PD5
15	PD6	16	PD7
17	PD8	18	PD9
19	PD10	20	PD11
21	PD12	22	PD13
23	PD14	24	PD15
25	PD16	26	PD17
27	PD18	28	PD19
29	PD20	30	PD21
31	PD22	32	PD23
33	PD24	34	PD25
35	SHFCLK	36	FLM
37	DE	38	LP
39	GND	40	ENABKL
41	P26	42	P27
43	P28	44	P29
45	P30	46	P31
47	P32	48	P33
49	P34	50	P35

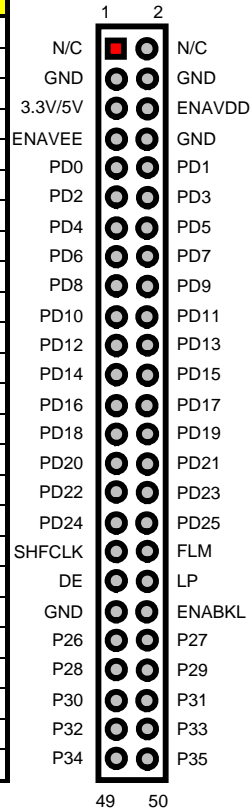

NOTE: Please set the proper voltage of your panel using JP7 before proceeding on installing it.

The HS-2608 has an onboard jumper that selects the working voltage of the flat panel connected to the system. Jumper JP7 offers two voltage settings for the user.

● **JP7: Panel Voltage Select**

Options	Settings
+3.3V (default)	Short 1-2
+5V	Short 2-3

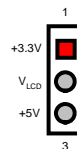

3.9 PCI E-IDE Drive Connector

CN23 is a standard 44-pin 2.0mm pitch connector daisy-chain driver connector serves the PCI E-IDE drive provisions onboard the HS-2608. A maximum of two ATA/33/66/100 IDE drives can be connected to the HS-2608 via CN23.

- **CN23: IDE Connector**

PIN	Description	PIN	Description
1	IDERST	2	GND
3	PDD7	4	PDD8
5	PDD6	6	PDD9
7	PDD5	8	PDD10
9	PDD4	10	PDD11
11	PDD3	12	PDD12
13	PDD2	14	PDD13
15	PDD1	16	PDD14
17	PDD0	18	PDD15
19	GND	20	N/C
21	PDDREQ	22	GND
23	IOW#	24	GND
25	IOR#	26	GND
27	PIORDY	28	470Ω with GND
29	PDDACK#	30	GND
31	IRQ14	32	N/C
33	PDA1	34	PD33/66
35	PDA0	36	PDA2
37	PDCS1#	38	PDCS3#
39	HDD Active	40	GND
41	VCC	42	VCC
43	GND	44	N/C

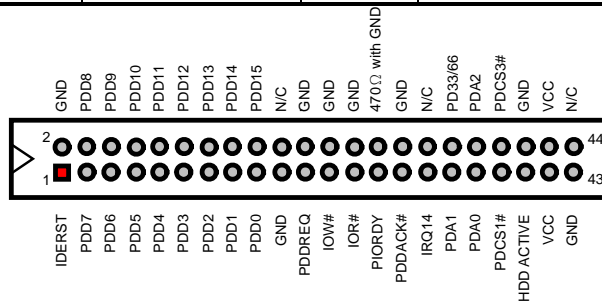

3.10 Floppy Disk Drive Connector

The HS-2608 uses a standard 34-pin header connector, CN8, for floppy disk drive connection. A total of two FDD drives may be connected to CN8 at any given time.

- **CN8: Floppy Connector**

PIN	Description	PIN	Description
1	GND	2	DRVDE0
3	GND	4	N/C
5	GND	6	DRVDE1
7	GND	8	INDEX#
9	GND	10	MTR0#
11	GND	12	DS1#
13	GND	14	DS0#
15	GND	16	MTR1#
17	GND	18	DIR#
19	GND	20	STEP#
21	GND	22	WDATA#
23	GND	24	WGATE#
25	GND	26	TRAK00#
27	GND	28	WRTPRT#
29	GND	30	RDATA#
31	GND	32	HDSEL#
33	GND	34	DSKCHG#

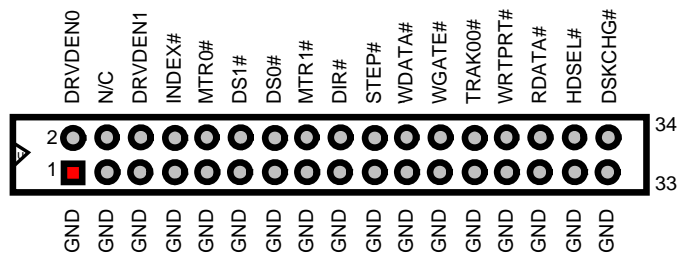

3.11 Serial Port Connectors

The HS-2608 offers two NS16C550 compatible UARTs with Read/Receive 16-byte FIFO serial ports and four internal 10-pin headers and one RS-422/485 connector.

- **CN16: COM1 Connector (5x2 Header)**

PIN	Description	PIN	Description
1	DCD1	2	DSR1
3	RXD1	4	RTS1
5	TXD1	6	CTS1
7	DTR1	8	RI1
9	GND	10	N/C

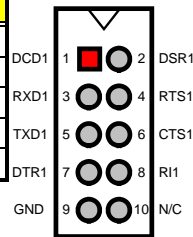

- **CN18: COM2 Connector (5x2 Header)**

PIN	Description	PIN	Description
1	DCD2	2	DSR2
3	RXD2	4	RTS2
5	TXD2	6	CTS2
7	DTR2	8	RI2
9	GND	10	N/C

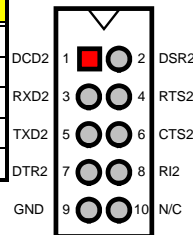

- **CN14: COM3 Connector (5x2 Header)**

PIN	Description	PIN	Description
1	DCD3	2	DSR3
3	RXD3	4	RTS3
5	TXD3	6	CTS3
7	DTR3	8	RI3
9	GND	10	N/C

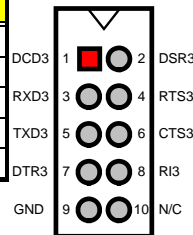

- **CN19: COM4 Connector (5x2 Header)**

PIN	Description	PIN	Description
1	DCD4	2	DSR4
3	RXD4	4	RTS4
5	TXD4	6	CTS4
7	DTR4	8	RI4
9	GND	10	N/C

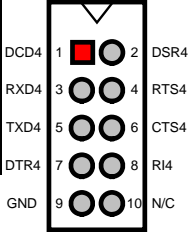

- **CN10: RS-422/485 Connector (5x2 Header, COM2)**

PIN	Description	PIN	Description
1	TX-	2	TX+
3	RX+	4	RX-
5	GND	6	RTS-

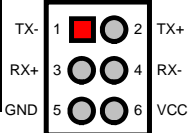

NOTE: The terminal resistance of RX & TX is set at 180Ω.

- **JP5(7-8): RS-422/485 Receiver Enabled/Disabled Select**

Options	Settings
Always Enable	Short
Always Disabled (default)	Open

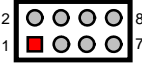

- **JP6: COM2 use RS-232 or RS-422/485 Select**

Options	Settings
RS-232 (default)	Open
RS-422/485	Short



NOTE: RS-422/485 port uses COM2. RS-232 of COM2 cannot be used while RS-422/485 is selected.

3.12 Parallel Connector

CN12 is a standard 26-pin flat cable connector deigned to accommodate parallel port connection on the HS-2608.

- **CN12: Parallel Connector**

PIN	Description	PIN	Description
1	Strobe	14	Auto Form Feed
2	DATA 0	15	ERROR#
3	DATA 1	16	Initialize
4	DATA 2	17	Printer Select LN#
5	DATA 3	18	GND
6	DATA 4	19	GND
7	DATA 5	20	GND
8	DATA 6	21	GND
9	DATA 7	22	GND
10	Acknowledge	23	GND
11	Busy	24	GND
12	Paper Empty	25	GND
13	Printer Select	26	GND

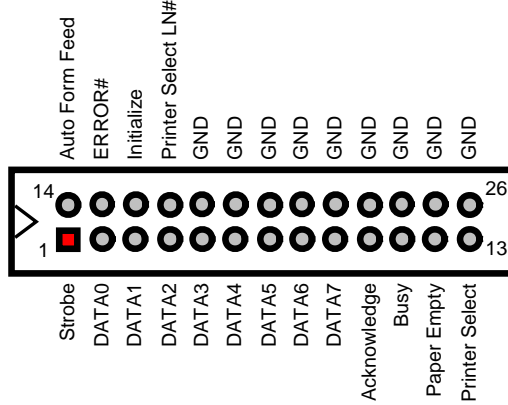

3.13 Ethernet Connector

The HS-2608 provides two external RJ-45 interface connectors. Please refer to the following for its pin information.

- **CN13/CN28: RJ-45 Connector**

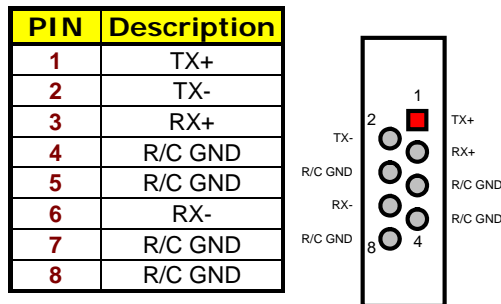

3.14 USB Connector

The HS-2608 provides one 8-pin connectors, at location *CN1*, for two USB connections to the HS-2608.

- **CN1: USB Connector**

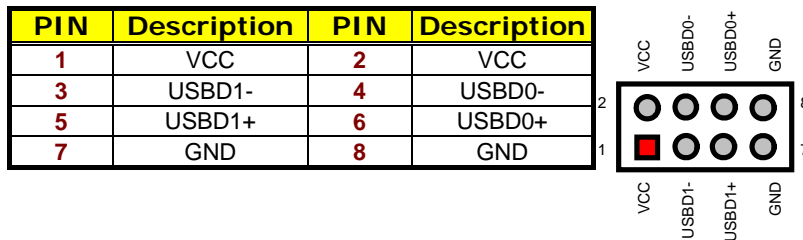

3.15 CMOS Data Clear

The HS-2608 has a Clear CMOS jumper on *JP2*.

- **JP2: Clear CMOS**

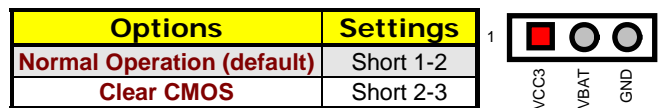

IMPORTANT: Before you turn on the power of your system, please set JP2 to Short 1-2 for normal operation.

3.16 Power and Fan Connectors

HS-2608 provides one 5-pin power connectors at CN2. And one 2-pin power in at CN5.

- **CN2: 5-pin ATX Power In Connector**

PIN	Description	PIN	Description
1	GND	2	PS_ON
3	+12V	4	5VSB
5	VCC		

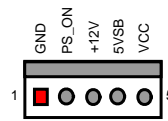

- **CN5: 2-pin Power In Connector**

PIN	Description
1	VCC
2	GND

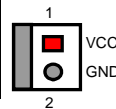

- **FN1: Fan Connector**

PIN	Description
1	CPU Fan1
2	+5V
3	GND

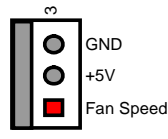

Connector *FN1* onboard HS-2608 is a 3-pin fan power output connector. And HS-2608 supports +5V Fan only.

3.17 Keyboard/Mouse Connectors

The HS-2608 offers two possibilities for keyboard/mouse connections. The connections are via *CN15* for an external PS/2 type keyboard/mouse or via *CN17* for an internal 6-pin cable converter to an keyboard/mouse.

- **CN15: PS/2 6-pin Mini DIN Keyboard/Mouse Connector**

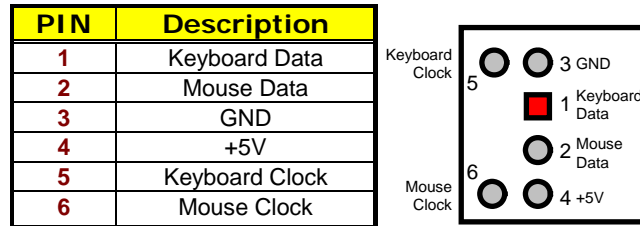

- **CN17: 6-pin Keyboard/Mouse Connector**

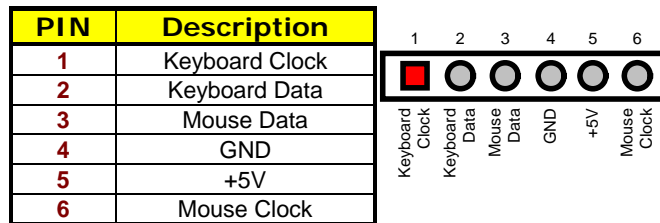

3.18 System Front Panel Connectors

The HS-2608 has one LED at location *JP3* that indicates the power-on status. This visual feature of the IDE LED may also be connected to an external IDE LED, Speaker, Reset Switch, Power LED, EXT SMI, Power Button, and SLP Button via connector *JP3*(13-15), *JP3*(1-3-5-7), *JP3*(9-11), *JP3*(2-4), *JP3*(6-8), *JP3*(10-12), *JP3*(14-16).

- **JP3: System Front Panel Connector**

PIN	Description	PIN	Description
1	330Ω Pull +5V	2	330Ω Pull +5V
3	GND	4	GND
5	+5V	6	EXT SMI
7	Speaker	8	GND
9	GND	10	PW Button
11	Reset Switch	12	GND
13	330Ω Pull +5V	14	SLP Button
15	HDD LED	16	GND

Connector JP3 Orientation

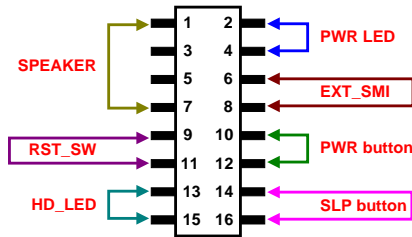

- **CN25: External Reset Button**

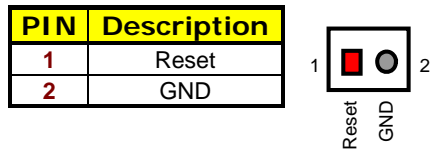

3.19 Watchdog Timer

There are three access cycles of Watch-Dog Timer as Enable, Refresh and Disable. The Enable cycle proceeds via READ PORT 443H whereas the Disable cycle proceeds via READ PORT 045H. A continued Enable cycle after a first Enable cycle means Refresh.

Once the Enable cycle is active, a Refresh cycle is requested before the time-out period. This restarts counting of the WDT period. When the time counting goes over the preset period of WDT, it will assume that the program operation is abnormal. A System Reset signal to re-start or a NMI cycle to the CPU transpires when such error happens. Jumper *JP1* is used to select the function of Watchdog Timer.

- **JP1: Watchdog Timer Active Type Setting**

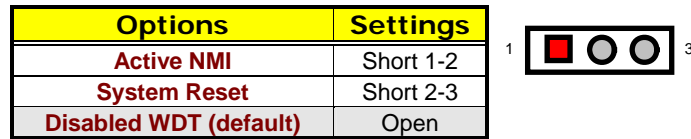

● **JP4(5-10): WDT Timeout Period Select**

Period	PINS 5-6	PINS 7-8	PINS 9-10
1 sec (default)	Short	Short	Short
2 sec	Open	Short	Short
10 sec	Short	Open	Short
20 sec	Open	Open	Short
110 sec	Short	Short	Open
220 sec	Open	Short	Open

The Watchdog Timer is disabled after the system Power-On. It can be enabled via an Enable cycle and reading the control port (443H), or via a Refresh cycle and reading the control port (443H), or via a Disable cycle and reading the disable control port (045H).

After an Enable cycle of WDT, user must immediately execute a Refresh cycle to WDT before its period setting comes to an end every 1, 2, 10, 20, 110 or 220 seconds. If the Refresh cycle does not activate before WDT period cycle, the onboard WDT architecture will issue a Reset or NMI cycle to the system. There are three I/O ports that control the Watchdog Timer.

443H	I/O Read	The Enable cycle
443H	I/O Read	The Refresh cycle
045H	I/O Read	The Disable cycle

The following sample program shows how to Enable, Disable and Refresh the Watchdog Timer:

```

WDT_EN_RF    EQU    0443H
WDT_DIS      EQU    0045H

WT_Enable    PUSH    AX                ; keep AX DX
              PUSH    DX
              MOV     DX,WDT_EN_RF    ; enable the WDT
              IN     AL,DX
              POP     DX                ; get back AX, DX
              POP     AX
              RET

WT_Refresh   PUSH    AX                ; keep AX, DX
              PUSH    DX
              MOV     DX,WDT_ET_RF    ; refresh the WDT
              IN     AL,DX
              POP     DX                ; get back AX, DX
              POP     AX
              RET

```

```

WT_DISABLE   PUSH   AX
              PUSH   DX
              MOV    DX,WDT_DIS    ; disable the WDT
              IN     AL,DX
              POP    DX             ; get back AX, DX
              POP    AX
              RET

```

3.20 Mini PCI Connector

HS-2608 supports a Mini PCI connector. The peripheral component with standard Type1 Mini PCI can be used. For particular requirement, please refer to “BOSER Mini PCI series product” on website or contact with us.

- **PC1: Mini PCI Connector**

PIN	Description	PIN	Description
1	INTB#	2	5V
3	3.3V	4	INTD#
5	INTA#	6	INTC#
7	GND	8	N/C
9	CLK	10	RST#
11	GND	12	3.3V
13	REQ#	14	GNT#
15	3.3V	16	GND
17	AD[31]	18	PME#
19	AD[29]	20	GNT1
21	GND	22	AD[30]
23	AD[27]	24	3.3V
25	AD[25]	26	AD[28]
27	REQ1	28	AD[26]
29	C/BE[3]#	30	AD[24]
31	AD[23]	32	AD[21]
33	GND	34	GND
35	AD[21]	36	AD[22]
37	AD[19]	38	AD[20]
39	GND	40	PAR
41	AD[17]	42	AD[18]
43	C/BE[2]#	44	AD[16]
45	IRDY#	46	GND
47	3.3V	48	FRAME#
49	N/C	50	TRDY#

... More on next page ...

PIN	Description	PIN	Description
51	SERR#	52	STOP#
53	GND	54	3.3V
55	PERR#	56	DEVSEL#
57	C/BE[1]#	58	GND
59	AD[14]	60	AD[15]
61	GND	62	AD[13]
63	AD[12]	64	AD[11]
65	AD[10]	66	GND
67	GND	68	AD[9]
69	AD[8]	70	C/BE[0]#
71	AD[7]	72	3.3V
73	3.3V	74	AD[6]
75	AD[5]	76	AD[4]
77	REQ2	78	AD[2]
79	AD[3]	80	AD[0]
81	5V	82	GNT2
83	AD[1]	84	GNT3
85	GND	86	GND
87	N/C	88	IRQ7
89	N/C	90	N/C
91	N/C	92	N/C
93	N/C	94	N/C
95	N/C	96	REQ3
97	N/C	98	N/C
99	N/C	100	N/C



**Mini PCI Socket
pin orientation**

3.21 PC/104 Connectors

The PC/104 expansion bus offers provisions to connect all types of PC/104 modules. With the PC/104 bus being known as the new generation of industrial embedded 16-bit PC standard bus, thousands of PC/104 modules from multiple vendors can be easily installed onboard. The detailed pin assignment of the PC/104 expansion bus connectors CN3 and CN4 are listed on the following tables:

NOTE : *The PC/104 connector allows direct plugging or stack-through piling of PC/104 modules without requiring the PC/104 mounting kit.*

● **CN3: PC/104 40-pin Connector**

PIN	Description	PIN	Description
1	GND	21	GND
2	-MEMCS16	22	-SBHE
3	-IOSC16	23	SA23
4	IRQ10	24	SA22
5	IRQ11	25	SA21
6	IRQ12	26	SA20
7	IRQ15	27	SA19
8	IRQ14	28	SA18
9	-DACK0	29	SA17
10	DRQ0	30	-MEMR
11	-DACK5	31	-MEMW
12	DRQ5	32	SD8
13	-DACK6	33	SD9
14	DRQ6	34	SD10
15	-DACK7	35	SD11
16	DRQ7	36	SD12
17	+5V	37	SD13
18	-MASTER	38	SD14
19	GND	39	SD15
20	GND	40	N/C

Connector diagram rotated 90 degrees clockwise from original position

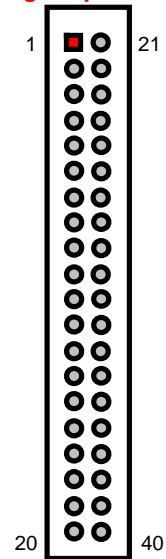

● **CN4: PC/104 64-pin Connector**

PIN	Description	PIN	Description
1	-IOCHECK	33	GND
2	SD7	34	RESETDRV
3	SD6	35	+5V
4	SD5	36	IRQ9
5	SD4	37	N/C
6	SD3	38	N/C
7	SD2	39	N/C
8	SD1	40	N/C
9	SD0	41	N/C
10	IOCHRDY	42	GND
11	AEN	43	-SMEMW
12	SA19	44	-SMEMR
13	SA18	45	-IOW
14	SA17	46	-IOR
15	SA16	47	-DACK3
16	SA15	48	DRQ3
17	SA14	49	-DACK1
18	SA13	50	DRQ1
19	SA12	51	-REFRESH
20	SA11	52	SYSCLK
21	SA10	53	IRQ7
22	SA9	54	IRQ6
23	SA8	55	IRQ5
24	SA7	56	IRQ4
25	SA6	57	IRQ3
26	SA5	58	-DACK2
27	SA4	59	TC
28	SA3	60	BALE
29	SA2	61	+5V
30	SA1	62	OSC
31	SA0	63	N/C
32	GND	64	GND

Connector diagram rotated 90 degrees clockwise from original position

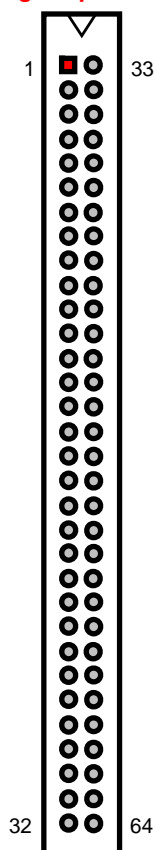

3.22 Audio Connectors

The HS-2608 has an onboard AC97 3D audio interface. The following tables list the pin assignments of the Line In/Audio Out connector.

- **CN9: Line In/Audio Out Connector**

PIN	Description	PIN	Description
1	AOUTL	2	AOUTR
3	GND	4	GND
5	MIC IN	6	LIR
7	GND	8	LIL

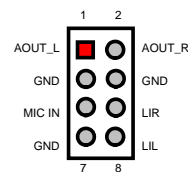

3.23 CompactFlash™ Connector

The HS-2608 also offers an optional CompactFlash™ connector which is IDE interface located at the solder side of the board (beneath the SO-DIMM connector). The designated CN24 connector, once soldered with an adapter, can hold CompactFlash™ cards of various sizes. Please turn off the power before inserting the CD card.

- **CN24: CompactFlash™ Connector**

PIN	Description	PIN	Description
1	GND	2	DATA 3
3	DATA 4	4	DATA 5
5	DATA 6	6	DATA 7
7	SDCS1#	8	GND
9	GND	10	GND
11	GND	12	GND
13	VCC (+5V)	14	GND
15	GND	16	GND
17	GND	18	SDA2
19	SDA1	20	SDA0
21	DATA 0	22	DATA 1
23	DATA 2	24	470Ω pull to GND
25	N/C	26	N/C
27	DATA 11	28	DATA 12
29	DATA 13	30	DATA 14
31	DATA 15	32	SDCS3#

... More on next page ...

PIN	Description	PIN	Description
33	N/C	34	IOR
35	IOW	36	EWE0
37	IRQ	38	VCC (+5V)
39	CS	40	N/C
41	Reset	42	IORDY
43	N/C	44	REQ 0
45	IDE LED	46	PDIAG
47	DATA 8	48	DATA 9
49	DATA 10	50	GND

Inserting a CompactFlash™ card into the adapter is not a difficult task. The socket and card are both keyed and there is only one direction for the card to be completely inserted. Refer to the diagram on the following page for the traditional way of inserting the card.

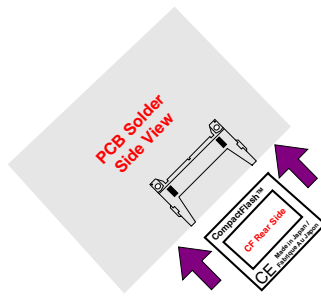

This page is intentionally left blank.

Chapter 4

Award BIOS Setup

The HS-2608 uses Award BIOS for the system configuration. The Award BIOS setup program is designed to provide the maximum flexibility in configuring the system by offering various options that could be selected for end-user requirements. This chapter is written to assist you in the proper usage of these features.

4.1 Starting Setup

The Award BIOS is immediately activated when you first power on the computer. The BIOS reads the system information contained in the CMOS and begins the process of checking out the system and configuring it. When it finishes, the BIOS will seek an operating system on one of the disks and then launch and turn control over to the operating system.

While the BIOS is in control, the Setup program can be activated in one of two ways:

1. By pressing immediately after switching the system on, or
2. By pressing the key when the following message appears briefly at the bottom of the screen during the POST (Power On Self Test).

Press DEL to enter SETUP.

If the message disappears before you respond and you still wish to enter Setup, restart the system to try again by turning it OFF then ON or pressing the "RESET" button on the system case. You may also restart by simultaneously pressing <Ctrl>, <Alt>, and <Delete> keys. If you do not press the keys at the correct time and the system does not boot, an error message will be displayed and you will again be asked to...

PRESS F1 TO CONTINUE, DEL TO ENTER SETUP

4.2 Using Setup

In general, you use the arrow keys to highlight items, press <Enter> to select, use the <PageUp> and <PageDown> keys to change entries, press <F1> for help and press <Esc> to quit. The following table provides more detail about how to navigate the Setup program using the keyboard.

Up arrow	Move to previous item
Down arrow	Move to next item
Left arrow	Move to the item in the left hand
Right arrow	Move to the item in the right hand
Esc key	Main Menu -- Quit and not save changes into CMOS Status Page Setup Menu and Option Page Setup Menu -- Exit current page and return to Main Menu
PgUp key	Increase the numeric value or make changes
PgDn key	Decrease the numeric value or make changes
+ key	Increase the numeric value or make changes
- key	Decrease the numeric value or make changes
F1 key	General help, only for Status Page Setup Menu and Option Page Setup Menu
(Shift)F2 key	Change color from total 16 colors. F2 to select color forward, (Shift) F2 to select color backward
F3 key	Calendar, only for Status Page Setup Menu
F4 key	Reserved
F5 key	Restore the previous CMOS value from CMOS, only for Option Page Setup Menu
F6 key	Load the default CMOS value from BIOS default table, only for Option Page Setup Menu
F7 key	Load the default
F8 key	Reserved
F9 key	Reserved
F10 key	Save all the CMOS changes, only for Main Menu

4.2.1 Getting Help

Press F1 to pop up a small help window that describes the appropriate keys to use and the possible selections for the highlighted item. To exit the Help Window press <Esc> or the F1 key again.

4.3 Main Menu

Once you enter the Award BIOS CMOS Setup Utility, the Main Menu will appear on the screen. The Main Menu allows you to select from several setup functions and two exit choices. Use the arrow keys to select among the items and press <Enter> to enter the sub-menu.

▶ Standard CMOS Features	▶ Frequency/Voltage Control
▶ Advanced BIOS Features	Load Fail-Safe Defaults
▶ Advanced Chipset Features	Load Optimized Defaults
▶ Integrated Peripherals	Set Supervisor Password
▶ Power Management Setup	Set User Password
▶ PnP/PCI Configurations	Save & Exit Setup
▶ PC Health Status	Exit Without Saving
Esc : Quit F9 : Menu in BIOS ↑↓→← : Select Item	
F10 : Save & Exit Setup	
Time, Date, Hard Disk Type...	

NOTE: *A brief description of the highlighted choice appears at the bottom of the screen.*

4.4 Standard CMOS Features

The Standard Setup is used for the basic hardware system configuration. The main function is for Data/Time and Floppy/Hard Disk Drive settings. Please refer to the following screen for the setup. When the IDE hard disk drive you are using is larger than 528MB, you must set the HDD mode to **LBA** mode. Please use the IDE Setup Utility in BIOS SETUP to install the HDD correctly.

Phoenix – AwardBIOS CMOS Setup Utility
Standard CMOS Features

		Item Help
Date (mm:dd:yy)	Mon, Aug 9 2004	Menu Level ▶ Change the day, month, year and century
Time (hh:mm:ss)	10 : 32 : 57	
▶ IDE Primary Master	[Auto]	
▶ IDE Primary Slave	[Auto]	
▶ IDE Secondary Master	[Auto]	
▶ IDE Secondary Slave	[Auto]	
Drive A	[1.44M, 3.5in.]	
Video	[EGA/VGA]	
Halt On	[All, But Keyboard]	
Base Memory	640K	
Extended Memory	252928K	
Total Memory	253952K	
↑↓→←: Select Item +/-/PU/PD: Value F10: Save ESC: Quit F1: General Help F5: Previous Values F6: Fail-Safe Defaults F7: Optimized Defaults		

4.5 Advanced BIOS Features

This section allows you to configure your system for the basic operation. You have the opportunity to select the system's default speed, boot-up sequence, keyboard operation, shadowing and security.

Phoenix – AwardBIOS CMOS Setup Utility
Advanced CMOS Features

		Item Help
Virus Warning	[Disabled]	Menu Level ►
CPU Internal Cache	[Enabled]	
External Cache	[Enabled]	
CPU L2 Cache ECC Checking	[Enabled]	
Processor Number Feature	[Enabled]	
Quick Power On Self Test	[Enabled]	
First Boot Device	[Floppy]	
Second Boot Device	[HDD-0]	
Third Boot Device	[CDROM]	
Boot Other Device	[Enabled]	
Swap floppy Drive	[Disabled]	
Boot Up Floppy Seek	[Enabled]	
Boot Up NumLock Status	[On]	
Gate A20 Option	[Fast]	
Typematic Rate Setting	[Disabled]	
X Typematic Rate (Chars/Sec)	6	
X Typematic Delay (Msec)	250	
Security Option	[Setup]	
OS Select For DRAM > 64MB	[Non-OS2]	
Video BIOS Shadow	[Enabled]	
C8000-CBFFF Shadow	[Disabled]	
CC000-CFFFF Shadow	[Disabled]	
D0000-D3FFF Shadow	[Disabled]	
D4000-D7FFF Shadow	[Disabled]	
D8000-DBFFF Shadow	[Disabled]	
DC000-DFFFF Shadow	[Disabled]	
Full Screen LOGO Show	[Disabled]	
Small Logo(EPA) Show	[Enabled]	
↑↓→←: Select Item +/-/PU/PD: Value F10: Save ESC: Quit F1: General Help F5: Previous Values F6: Fail-Safe Defaults F7: Optimized Defaults		

4.6 Advanced Chipset Features

This section allows you to configure the system based on the specific features of the installed chipset. This chipset manages bus speeds and the access to the system memory resources, such as DRAM and the external cache. It also coordinates the communications between the conventional ISA and PCI buses. It must be stated that these items should never be altered. The default settings have been chosen because they provide the best operating conditions for your system. You might consider making any changes only if you discover that the data has been lost while using your system.

Phoenix – AwardBIOS CMOS Setup Utility
Advanced Chipset Features

		Item Help
DRAM Timing By SPD	[Disabled]	
DRAM Clock	[Host CLK]	Menu Level ▶
SDRAM Cycle Length	[3]	
Bank Interleave	[Disabled]	
Memory Hole	[Disabled]	
P2C/C2P Concurrency	[Enabled]	
System BIOS Cacheable	[Enabled]	
Video RAM Cacheable	[Enabled]	
Frame Buffer Size	[16M]	
AGP Aperture Size	[64M]	
AGP-4X Mode	[Enabled]	
AGP Driving Control	[Auto]	
X AGP Driving Value	DA	
Select Display Device	[CRT]	
Panel Type	[00]	
OnChip USB	[Enabled]	
USB Keyboard Support	[Disabled]	
OnChip Sound	[Auto]	
CPU to PCI Write Buffer	[Enabled]	
PCI Dynamic Bursting	[Enabled]	
PCI Master 0 WS Write	[Enabled]	
PCI Delay Transaction	[Disabled]	
PCI#2 Access #1 Retry	[Enabled]	
AGP Master 1 WS Write	[Disabled]	
AGP Master 1 WS Read	[Disabled]	

↑↓→←: Select Item +/-/PU/PD: Value F10: Save ESC: Quit F1: General Help
F5: Previous Values F6: Fail-Safe Defaults F7: Optimized Defaults

4.7 Integrated Peripherals

The IDE hard drive controllers can support up to two separate hard drives. These drives have a master/slave relationship that is determined by the cabling configuration used to attach them to the controller. Your system supports two IDE controllers--a primary and a secondary--so you can install up to four separate hard disks.

PIO means Programmed Input/Output. Rather than having the BIOS issue a series of commands to affect the transfer to or from the disk drive, PIO allows the BIOS to tell the controller what it wants and then let the controller and the CPU perform the complete task by themselves. This is much simpler and more efficient (also faster).

Phoenix – AwardBIOS CMOS Setup Utility
Integrated Peripherals

		Item Help
On-Chip IDE Channel0	[Enabled]	Menu Level ▶
On-Chip IDE Channel1	[Enabled]	
IDE Prefetch Mode	[Enabled]	
Primary Master	PIO [Auto]	
Primary Slave	PIO [Auto]	
Secondary Master	PIO [Auto]	
Secondary Slave	PIO [Auto]	
Primary Master	UDMA [Auto]	
Primary Slave	UDMA [Auto]	
Secondary Master	UDMA [Auto]	
Secondary Slave	UDMA [Auto]	
Init Display First	[PCI Slot]	
IDE HDD Block Mode	[Enabled]	
Onboard FDD Controller	[Enabled]	
Onboard Serial Port 1	[3F8/IRQ4]	
Onboard Serial Port 2	[2F8/IRQ3]	
UART 2 Mode	[Standard]	
X IR Function Duplex	Half	
X TX, RX inverting enable	No, Yes	
Onboard Parallel Port	[378/IRQ7]	
Onboard Parallel Port Mode	[Normal]	
ECP Mode Use DMA	[3]	
Parallel Port EPP Type	[EPP1..9]	
Onboard Serial Port 3	[3E8]	
Serial Port 3 Use IRQ	[IRQ10]	
Onboard Serial Port 4	[2E8]	
Serial Port 4 Use IRQ	[IRQ11]	
Onboard Legacy Audio	[Enabled]	
Sound Blaster	[Disabled]	
SB I/O Base Address	[220H]	
SB IRQ Select	[IRQ 5]	
SB DMA Select	[DMA 1]	
MPU-401	[Disabled]	
MPU-401 I/O Address	[330-333H]	

↑↓→←: Select Item +/-/PU/PD: Value F10: Save ESC: Quit F1: General Help
F5: Previous Values F6: Fail-Safe Defaults F7: Optimized Defaults

4.8 Power Management Setup

The Power Management Setup allows user to configure the system for saving energy in a most effective way while operating in a manner consistent with his own style of computer use.

Phoenix – AwardBIOS CMOS Setup Utility Power Management Setup

ACPI function	[Disabled]	Item Help
▶ Power Management	[Press Enter]	Menu Level ▶
ACPI Suspend Type	[S1(POS)]	
PM Control by APM	[Yes]	
Video Off Option	[Suspend -> Off]	
Video Off Method	[V/H SYNC+Blank]	
MODEM Use IRQ	[NA]	
Soft-Off by PWRBTN	[Instant-Off]	
▶ Wake Up Events	[Press Enter]	
↑↓→←: Select Item +/-/PU/PD: Value F10: Save ESC: Quit F1: General Help F5: Previous Values F6: Fail-Safe Defaults F7: Optimized Defaults		

Phoenix – AwardBIOS CMOS Setup Utility Power Management

Power Management	[User Define]	Item Help
HDD Power Down	[Disabled]	Menu Level ▶
Doze Mode	[Disabled]	
Suspend Mode	[Disabled]	
↑↓→←: Select Item +/-/PU/PD: Value F10: Save ESC: Quit F1: General Help F5: Previous Values F6: Fail-Safe Defaults F7: Optimized Defaults		

Phoenix – AwardBIOS CMOS Setup Utility Wake Up Events

VGA	[OFF]	Item Help
LPT & COM	[LPT/COM]	Menu Level ▶
HDD & FDD	[ON]	
PCI Master	[OFF]	
Modem Ring Resume	[Disabled]	
RTC Alarm Resume	[Disabled]	
X Date (of Month)	0	
X Resume Time (hh:mm:ss)	0 : 0 : 0	
Primary INTR	[ON]	
▶ IRQs Activity Monitoring	[Press Enter]	
↑↓→←: Select Item +/-/PU/PD: Value F10: Save ESC: Quit F1: General Help F5: Previous Values F6: Fail-Safe Defaults F7: Optimized Defaults		

4.9 PnP/PCI Configurations

This section describes the configuration of the PCI bus system. PCI, or **P**eripheral **C**omponents **I**nterconnect, is a system that allows I/O devices to operate at speeds nearing the speed the CPU itself uses when communicating with its own special components. This section covers some very technical items and it is strongly recommended that only experienced users should make any changes to the default settings.

Phoenix – AwardBIOS CMOS Setup Utility
PnP/PCI Configurations

		Item Help
PNP OS Installed	[No]	Menu Level ► Default is Disabled. Select Enabled to reset Extended System Configuration Data (ESCD) when you exit Setup if you have Installed a new add-on And the system Reconfiguration has Caused such a serious Conflict that the OS Cannot boot
Reset Configuration Data	[Disabled]	
Resources Controlled By	[Auto(ESCD)]	
X IRQ Resources	Press Enter	
X DMA Resources	Press Enter	
PCI/VGA Palette Snoop	[Disabled]	
Assign IRQ For VGA	[Enabled]	
Assign IRQ For USB	[Enabled]	
↑↓→←: Select Item +/-/PU/PD: Value F10: Save ESC: Quit F1: General Help F5: Previous Values F6: Fail-Safe Defaults F7: Optimized Defaults		

4.10 PC Health Status

Phoenix – AwardBIOS CMOS Setup Utility
PC Health Status

Current CPU Temp. Current System Temp. Current CPUFAN1 Speed Current CPUFAN2 Speed VCORE 2.5V 3.3V 5V 12V	Item Help Menu Level ▶
↑↓→←: Select Item +/-/PU/PD: Value F10: Save ESC: Quit F1: General Help F5: Previous Values F6: Fail-Safe Defaults F7: Optimized Defaults	

4.11 Frequency/Voltage Control

Phoenix – AwardBIOS CMOS Setup Utility
Frequency/Voltage Control

Auto Detect DIMM/PCI Clk [Enabled] Spread Specturm [Disabled] CPU Host Clock (CPU/PCI) [Default]	Item Help Menu Level ▶
↑↓→←: Select Item +/-/PU/PD: Value F10: Save ESC: Quit F1: General Help F5: Previous Values F6: Fail-Safe Defaults F7: Optimized Defaults	

4.12 Load Fail-Safe Defaults

When you press <Enter> on this item you will get a confirmation dialog box with a message shown below. This option allows you to load/restore the BIOS default values permanently stored in the BIOS ROM. Pressing 'Y' loads the BIOS default values for the most stable, minimal-performance system operations.

Phoenix – AwardBIOS CMOS Setup Utility

▶ Standard CMOS Features	▶ Frequency/Voltage Control
▶ Advanced BIOS Features	Load Fail-Safe Defaults
▶ Advanced Chipset Features	Load Optimized Defaults
▶ Integrated Peripherals	Set Supervisor Password
▶ Power Management	Load Fail-Safe Defaults (Y/N)? N
▶ PnP/PCI Configurations	Save & Exit Setup
▶ PC Health Status	Exit Without Saving
Esc : Quit F9 : Menu in BIOS ↑↓→← : Select Item	
F10 : Save & Exit Setup	
Time, Date, Hard Disk Type...	

4.13 Load Optimized Defaults

When you press <Enter> on this item you get a confirmation dialog box with a message similar to the figure below. This option allows you to load/restore the default values to your system configuration, optimizing and enabling all high performance features. Pressing 'Y' loads the default values that are factory settings for optimal performance system operations.

Phoenix – AwardBIOS CMOS Setup Utility

▶ Standard CMOS Features	▶ Frequency/Voltage Control
▶ Advanced BIOS Features	Load Fail-Safe Defaults
▶ Advanced Chipset Features	Load Optimized Defaults
▶ Integrated Peripherals	Set Supervisor Password
▶ Power Managemen Load Optimized Defaults (Y/N)? N	word
▶ PnP/PCI Configurations	Save & Exit Setup
▶ PC Health Status	Exit Without Saving
Esc : Quit F9 : Menu in BIOS ↑↓→← : Select Item	
F10 : Save & Exit Setup	
Time, Date, Hard Disk Type...	

4.14 Set Supervisor/User Password

Phoenix – AwardBIOS CMOS Setup Utility

▶ Standard CMOS Features	▶ Frequency/Voltage Control
▶ Advanced BIOS Features	Load Fail-Safe Defaults
▶ Advanced Chipset Features	Load Optimized Defaults
▶ Integrated Peripherals	Set Supervisor Password
▶ Power Managemen Enter Password:	word
▶ PnP/PCI Configurations	Save & Exit Setup
▶ PC Health Status	Exit Without Saving
Esc : Quit F9 : Menu in BIOS ↑↓→← : Select Item	
F10 : Save & Exit Setup	
Time, Date, Hard Disk Type...	

You can set either supervisor or user password, or both of them. The differences between are:

- **supervisor password:** can enter and change the options of the setup menus.
- **user password:** just can only enter but do not have the right to change the options of the setup menus.

When you select this function, the following message will appear at the center of the screen to assist you in creating a password.

ENTER PASSWORD:

Type the password, up to eight characters in length, and press <Enter>. The password typed now will clear any previously entered password from CMOS memory. You will be asked to confirm the password. Type the password again and press <Enter>. You may also press <Esc> to abort the selection and not enter a password.

To disable a password, just press <Enter> when you are prompted to enter the password. A message is confirmed and the password will be disabled. Once the password is disabled, the system will boot and you can enter Setup freely.

PASSWORD DISABLED.

When a password has been enabled, you will be prompted to enter it every time you try to enter Setup. This prevents an unauthorized person from changing any part of your system configuration.

Additionally, when a password is enabled, you can also require the BIOS to request a password every time your system is rebooted. This would prevent unauthorized use of your computer.

You determine when the password is required within the BIOS Features Setup Menu and its Security option (see Section 3). If the Security option is set to "System", the password will be required both at boot and at entry to Setup. If set to "Setup", prompting only occurs when trying to enter Setup.

4.15 Save & Exit Setup

Press <Enter> on this item for confirmation:

Pressing “Y” stores the selections made in the menus in CMOS – a special section of memory that stays on after you turn your system off. The next time you boot your computer, the BIOS configures your system according to the Setup selections stored in CMOS. After saving the values the system is restarted again.

▶ Standard CMOS Features	▶ Frequency/Voltage Control
▶ Advanced BIOS Features	Load Fail-Safe Defaults
▶ Advanced Chipset Features	Load Optimized Defaults
▶ Integrated Peripherals	Set Supervisor Password
▶ Power Managemen	SAVE to CMOS and EXIT (Y/N)? N word
▶ PnP/PCI Configurations	Save & Exit Setup
▶ PC Health Status	Exit Without Saving
Esc : Quit F9 : Menu in BIOS ↑↓→← : Select Item	
F10 : Save & Exit Setup	
Time, Date, Hard Disk Type...	

4.16 Exit Without Saving

Pressing <Enter> on this item asks for confirmation:

Quit without saving (Y/N)? **Y**

This allows you to exit Setup without storing any change in CMOS. The previous selections remain in effect. This exits the Setup utility and restarts your computer.

Phoenix – AwardBIOS CMOS Setup Utility

▶ Standard CMOS Features	▶ Frequency/Voltage Control
▶ Advanced BIOS Features	Load Fail-Safe Defaults
▶ Advanced Chipset Features	Load Optimized Defaults
▶ Integrated Peripherals	Set Supervisor Password
▶ Power Manageme	Quit without Saving (Y/N)? N word
▶ PnP/PCI Configurations	Save & Exit Setup
▶ PC Health Status	Exit Without Saving
Esc : Quit F9 : Menu in BIOS ↑↓→← : Select Item	
F10 : Save & Exit Setup	
Time, Date, Hard Disk Type...	

This page is intentionally left blank.

Chapter 5

Software Utilities

This chapter contains the detailed information of IDE, VGA and LAN driver installation procedures.

5.1 IDE Driver Installation

The utility disk that came with the delivery package contains an auto-run program that invokes the installation programs for the IDE, VGA and Audio drivers. The following describes the installation procedures of each driver.

1. Insert Utility CD Disk to your CD ROM. The main menu will pop up as shown below.

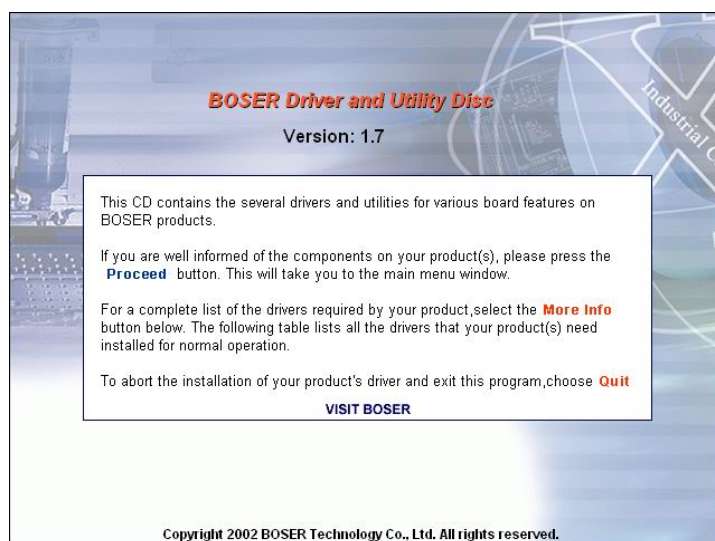

2. Press "VIA 4 IN 1" and to go Setup.

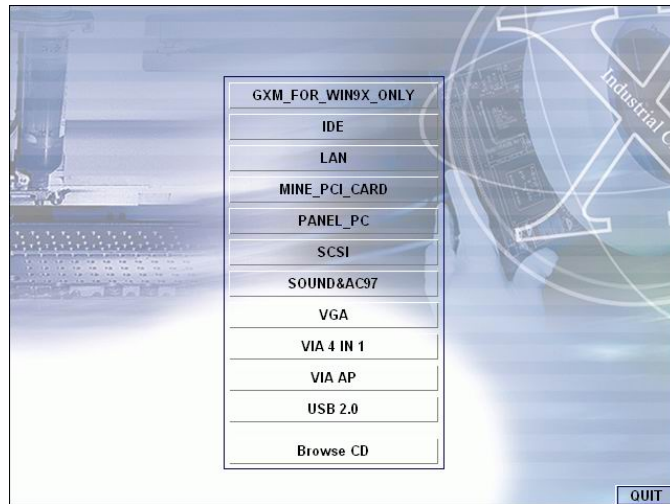

3. Once the Welcome screen appears on the screen, make sure to close any applications running and then click on the Next button.

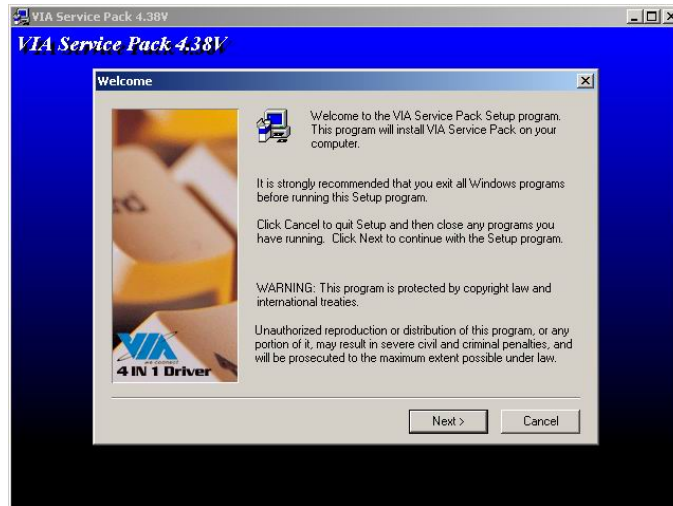

4. When the Readme window pops on the screen, you may read the whole document including the license agreement or just press Yes to skip through and continue installation.

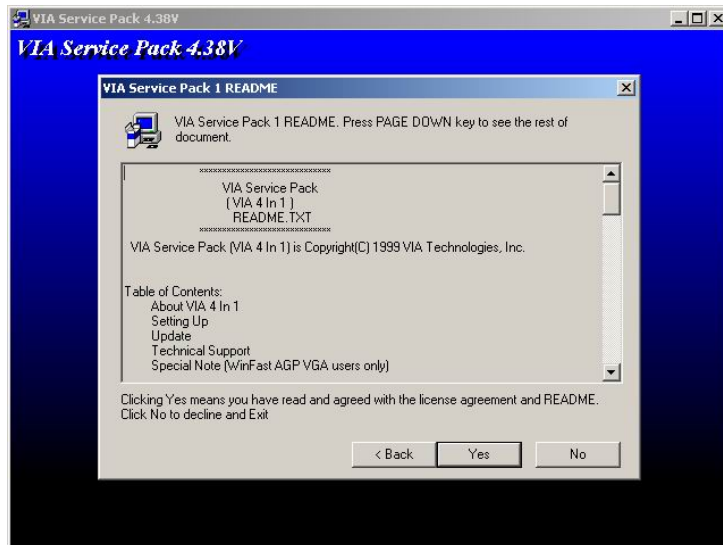

5. The 4 in 1 Setup dialog is now displayed. Select on Normally Install and then click on Next.

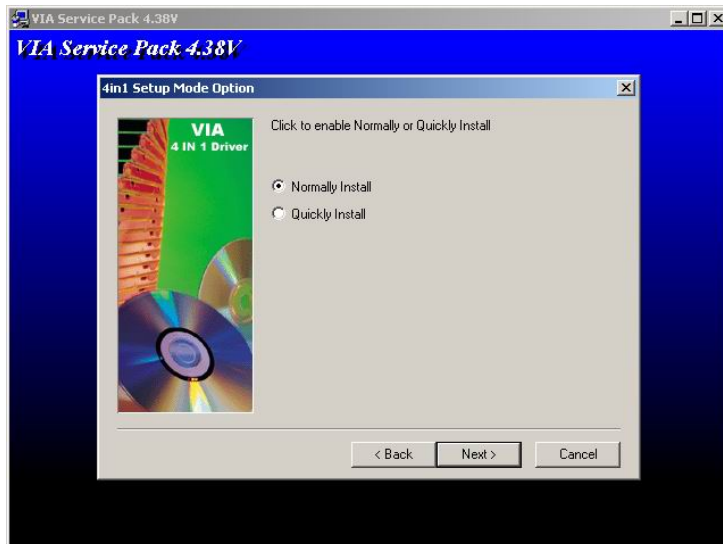

- The next window lists all components detected in your system and asks you to select the ones requiring drivers. Tick on all items then proceed by clicking on the Next button below the screen.

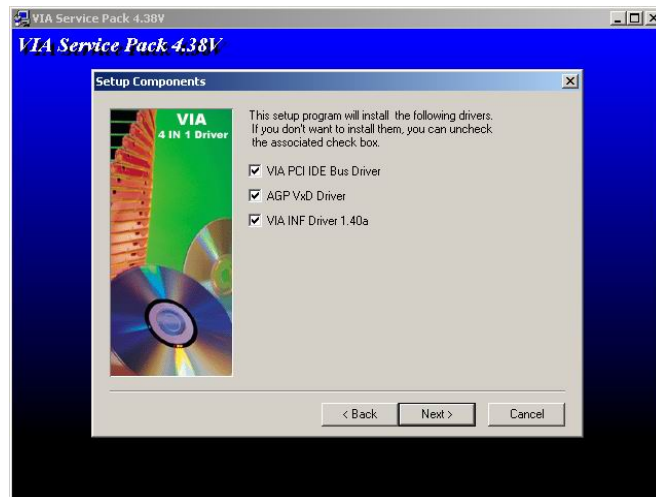

- The program starts to install the ATAPI driver when you click the Next button on the screen below.

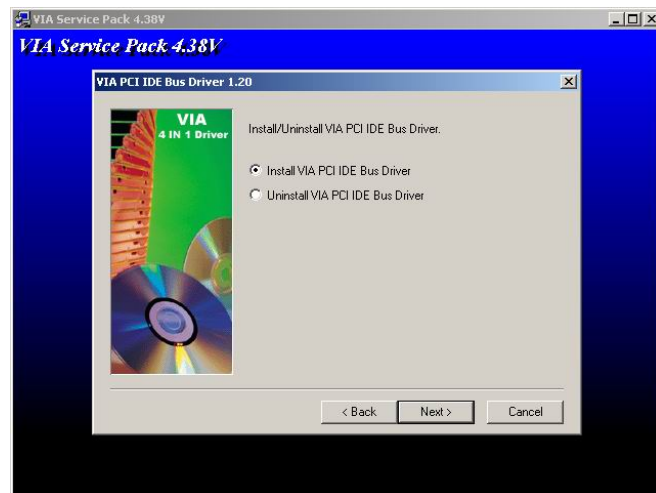

- When the ATAPI driver is completely installed. The utility then displays your DMA mode status and allows you to enable it. Tick on the box and press on the Next button to continue.

9. The following screen then gives you the choice of installing the AGP driver in standard or turbo mode. Select on the Standard Mode and then click on Next to proceed.

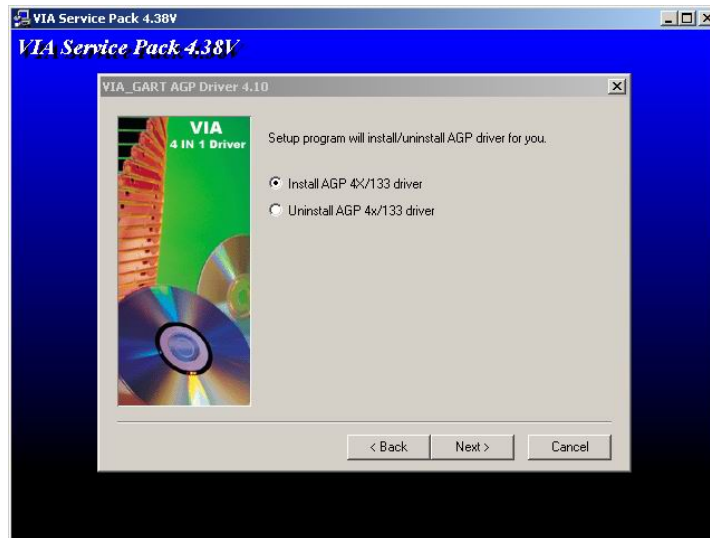

10. Installation of the AGP driver is now complete. Once the screen below appears, select on restarting your computer to activate all drivers/settings completed.

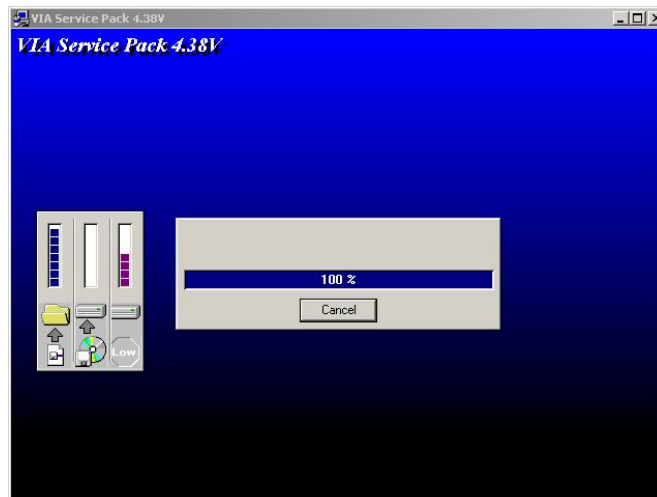

5.2 VGA Driver Installation

5.2.1 VGA Driver Installation for WIN95/98/2K

1. With the Utility CD Disk still in your CD ROM drive, open the File Manager and then select the CD-ROM drive. As soon as the system reads the disk, the VGA Menu screen below will appear on your display. Click on VIA_8606 from the main menu.

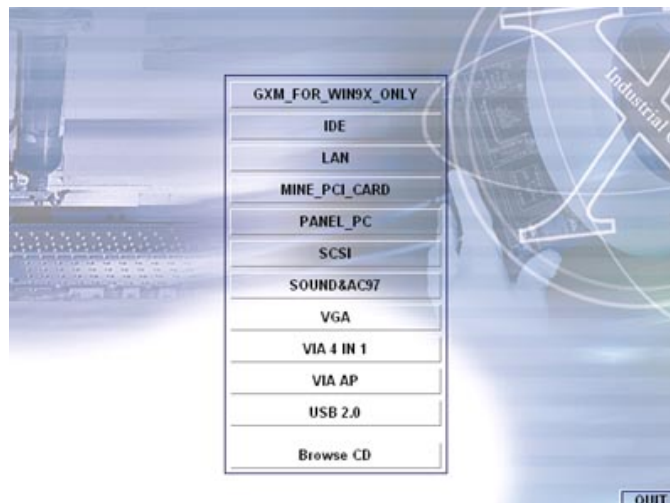
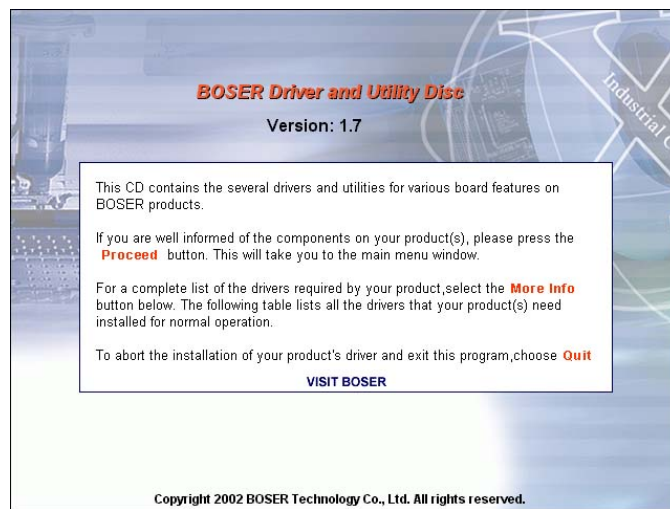



2. Select the operating system of your computer to proceed with the installation process.

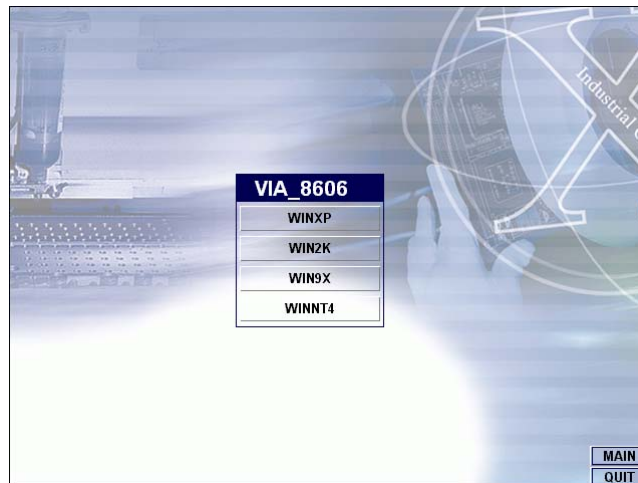

3. Once the Welcome screen appears on the screen, make sure to close applications that are running and then click the Next button.



4. When the display below appears on your screen, Setup is already ready to install and copy the related files onto your hard drive. Click on the Next button to proceed.



5. After the installation finishes, you will be prompted to restart your system. We recommend you to reboot your computer to allow the new settings to take effect. Click on the Finish button to reboot.

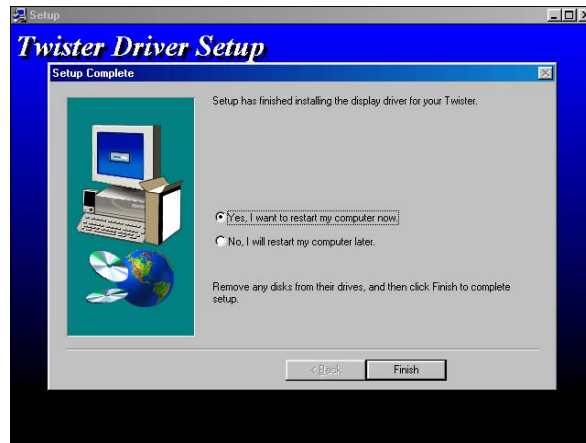

5.2.2 VGA Driver Installation for WIN NT4.0

1. Click the **Start** button on the lower left hand corner of your screen, then select **Setting**. Choose **Control Panel** and double-click on the **Display** icon to launch its **Display Properties** window. Click on the **Settings** tab, and then choose **Display Type**. In the **Change Display Type** window, click on **Have Disk**.

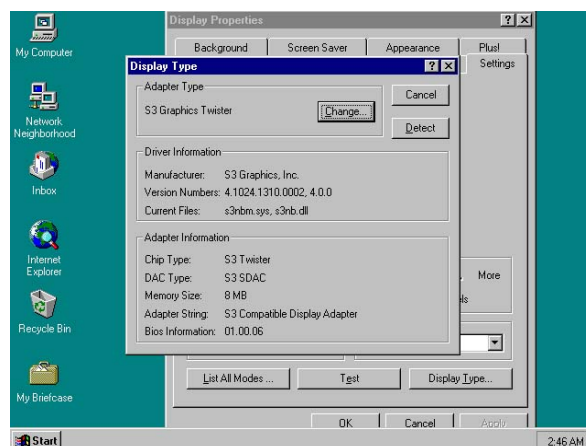

- Specify the path of the new driver and then press on **Enter**. (If in driver D:, type d:\Vga/Via_8606/Nt40)

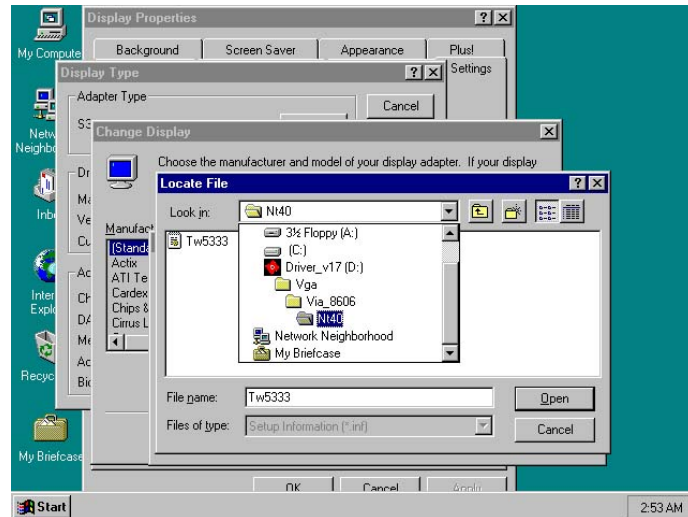

- Select

S3 Graphics Twister

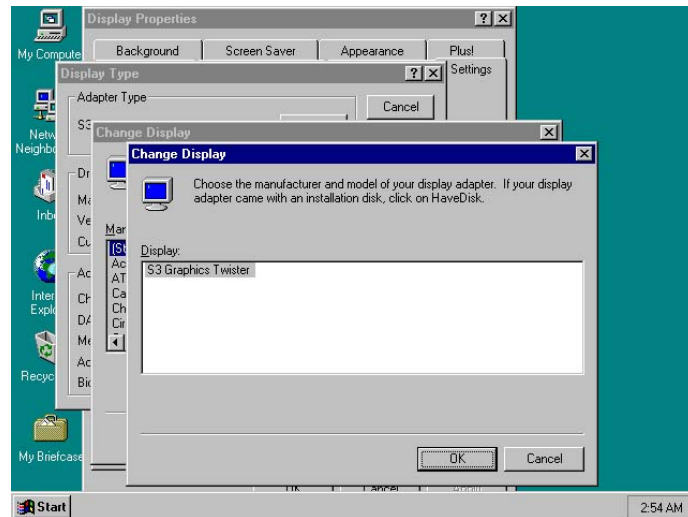

- Click **OK** or press **Enter**.

7. You will see warning panel about **Third Party Drivers**. Click on **Yes** to finish the installation.

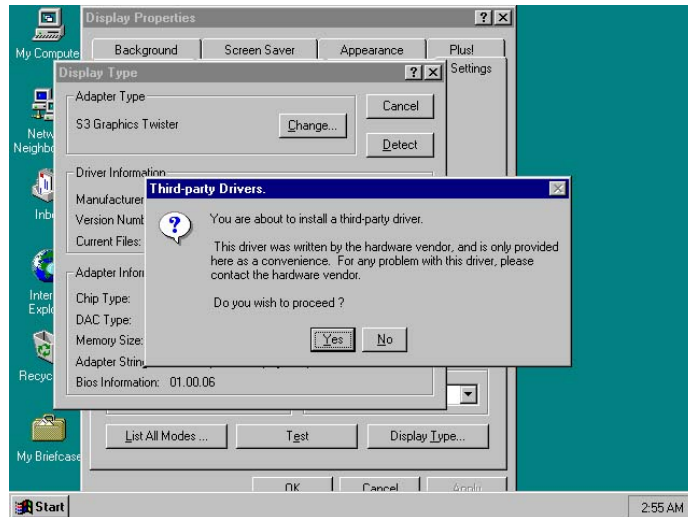

8. Once the installation is completed, you must shut down the system and restart for the new driver to take effect.

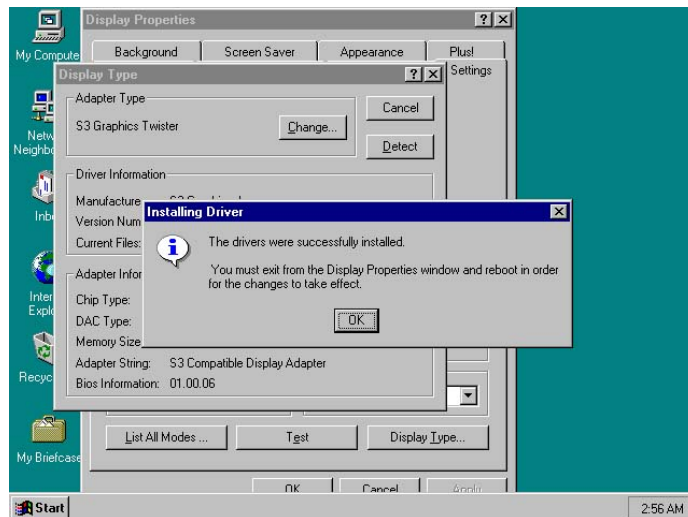

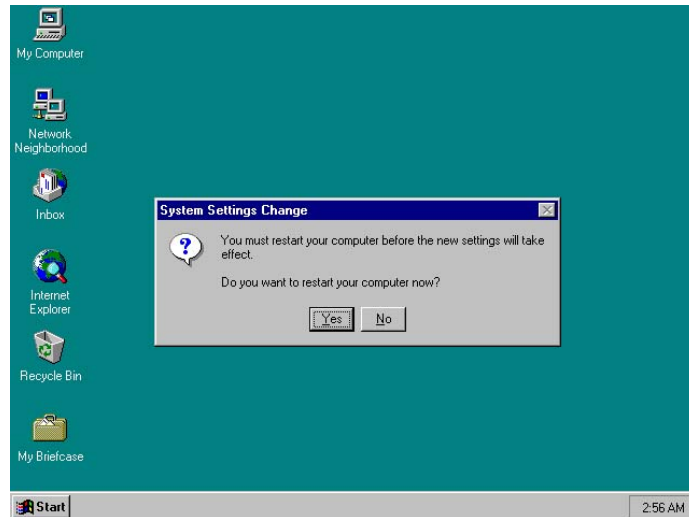

5.3 LAN Driver Installation

5.3.1 LAN Driver Installation for WIN95/98/2K

1. With the Utility CD Disk still in your CD ROM drive, right click on My Computer icon from the Windows menu. Select on System Properties and then proceed to the Device Manager from the main menu.

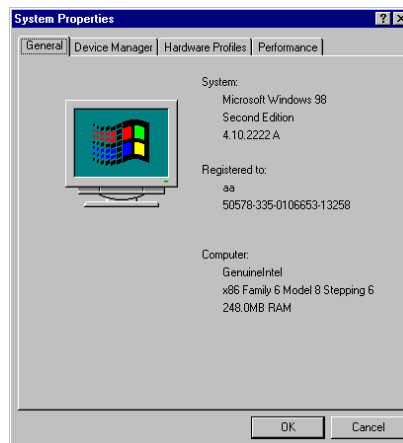

2. Select on Other Devices from the list of devices then double-click on PCI Ethernet Controller.

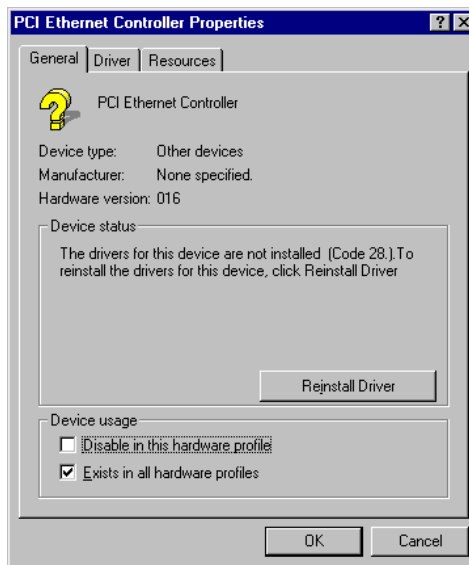
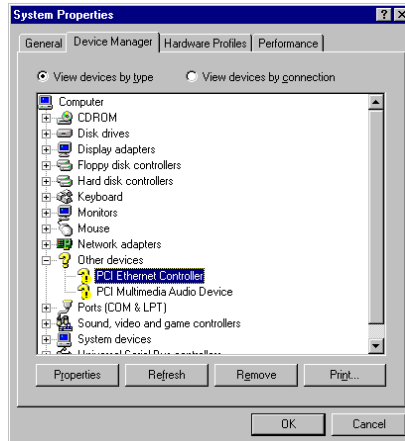

3. The PCI Ethernet Controller Properties screen then appears, allowing you to re-install the driver. Select Driver from the main menu to proceed.

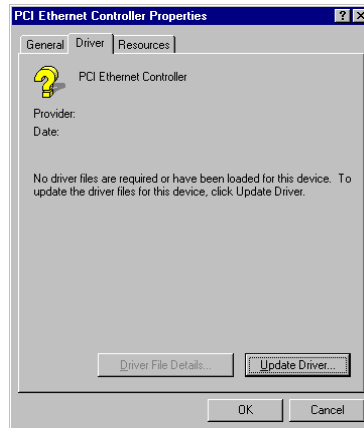

4. The window then displays the current status of your LAN driver. Press on Update Driver button to continue.
5. The program will then launch the Update Device Driver Wizard window that will install your device driver. Click on the Next button to proceed to the next step.



- When the succeeding window asks you what you wish Windows to do, tick on the "Search for a better driver...." Click on the Next button to proceed.



- The Update Device Driver Wizard will then ask you to specify, by ticking, the path of the new driver. Tick on the open boxes where you require the program to search for the device driver then click on the Browse button to manually specify the path.



8. Press on the OK button as soon as you have located the path of your driver.

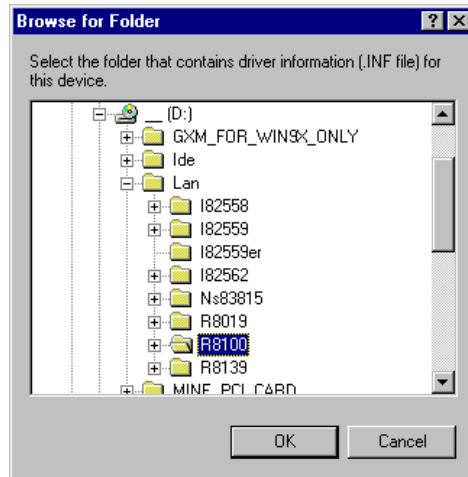

9. Once the program returns to the Add New Hardware Wizard screen, your specified location will appear. Press on the Next button to continue.



10. Once the program detects the device driver (*.inf) file from your specified location, it will automatically copy the files into your hard drive.

11. When copying of driver files finishes, the program will then ask you to insert your Windows.



12. The program then copies the necessary files from your Windows installation disk to complete the driver setup process. Once the driver is completely installed, the following message appears on your display. Click on the Finish button to proceed.

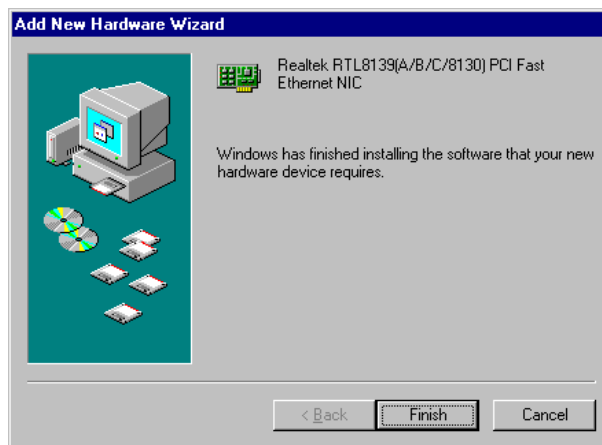

13. Restart your computer to make the new system settings take effect. Click on the Yes button when the screen below appears and your LAN Driver for Win95 and Win98 are now completely installed.



5.3.2 LAN Driver Installation for WIN NT4.0

1. With the Utility CD Disk still in your CD ROM drive, right click on Network Neighborhood icon from the Windows menu. Select on Properties.

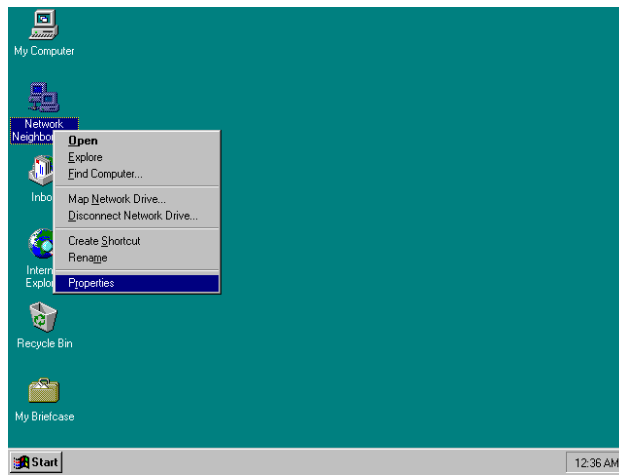

2. The system automatically detects the absence of Windows NT Networking. Click on the Yes button to start installation.

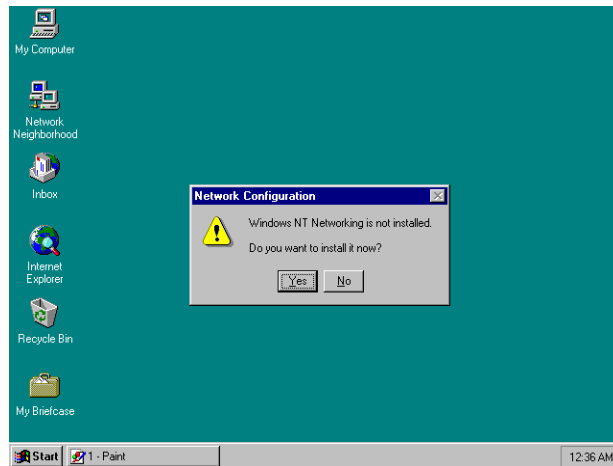

3. Tick on the "Wired to Network" once the following screen appears. Click on the Next to proceed.

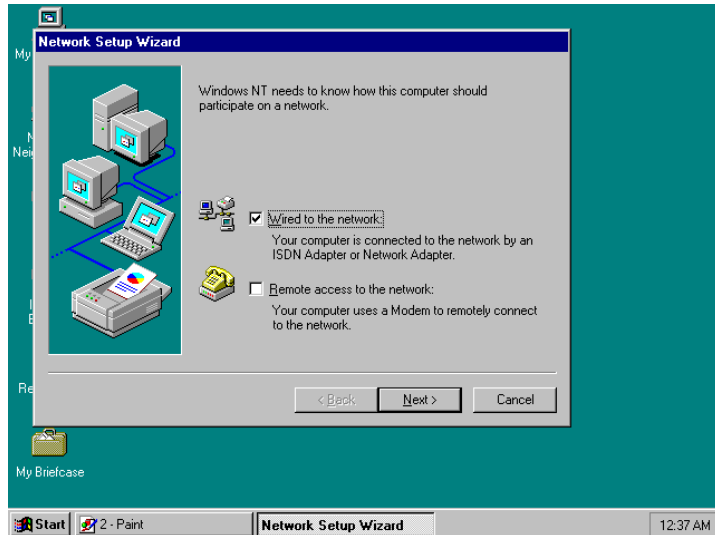

4. Click on the Start Search button for the program to locate the Network Adapter.

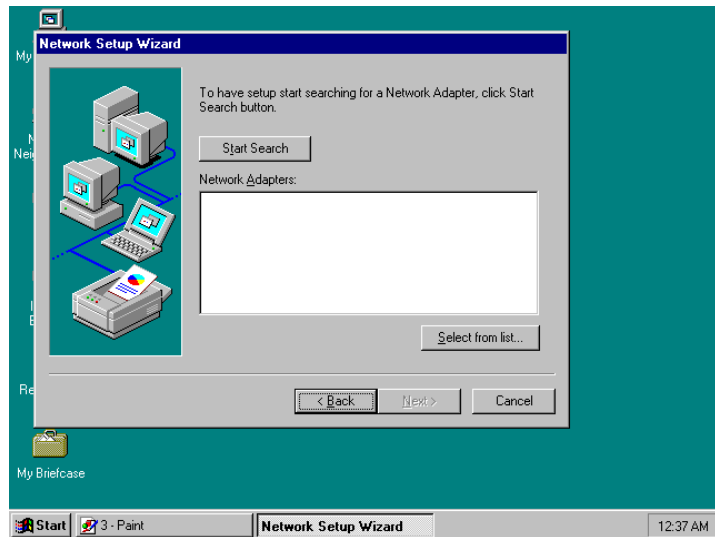

- Once setup finishes the search, it will list a number of adapters for you to choose from. Press on the Have Disk button to assign the driver path location.

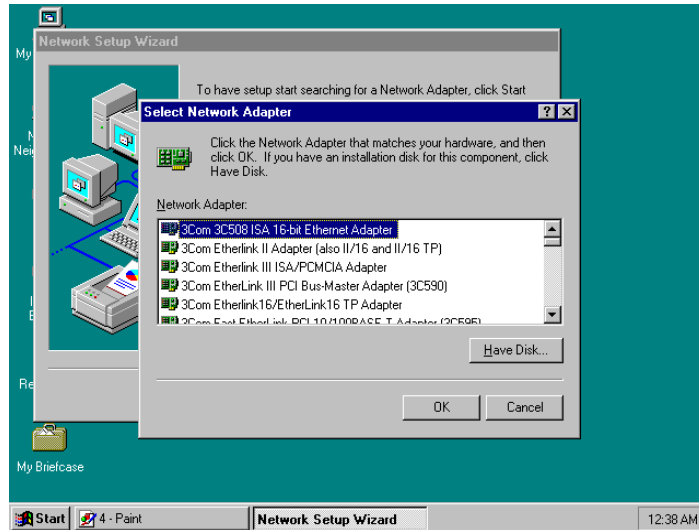

- Setup now asks you for the location of the driver. When you have entered the new driver path, press on the OK button to continue.

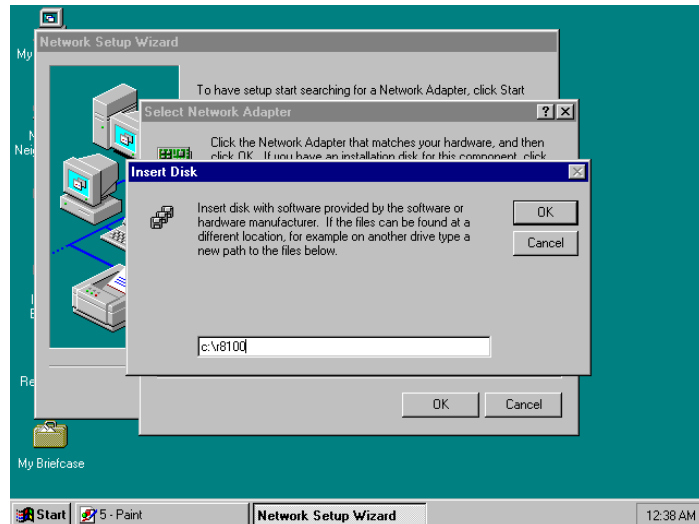

- When Setup finds the information it needs about the new driver, it will display the device it found on the following screen. Press on the OK button to accept and proceed.

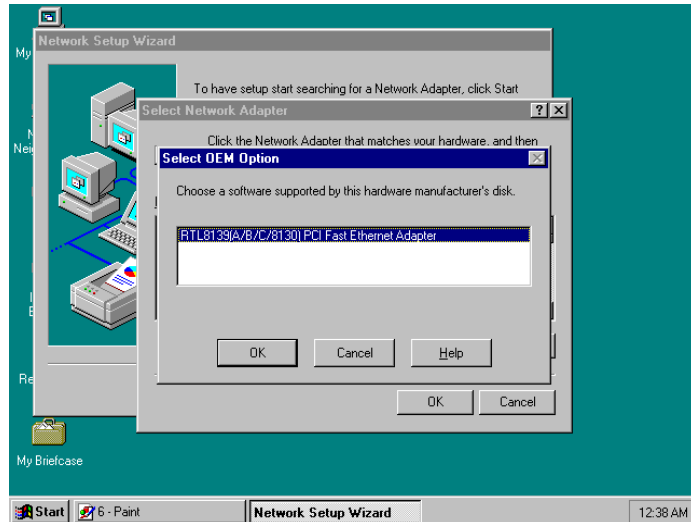

- Setup then returns to Network Setup Wizard screen and displays your new Network Adapter. Click on Next to continue.

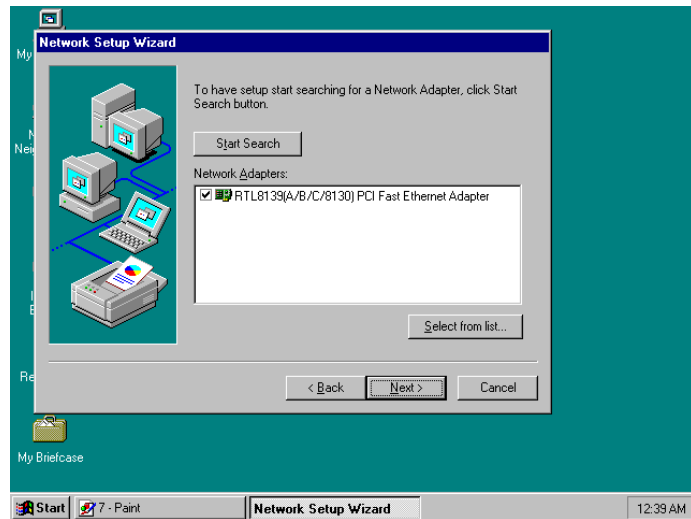

9. The Network Setup Wizard then allows you to set the Network Protocols on your network. Select the appropriate protocol and then click on Next to continue.

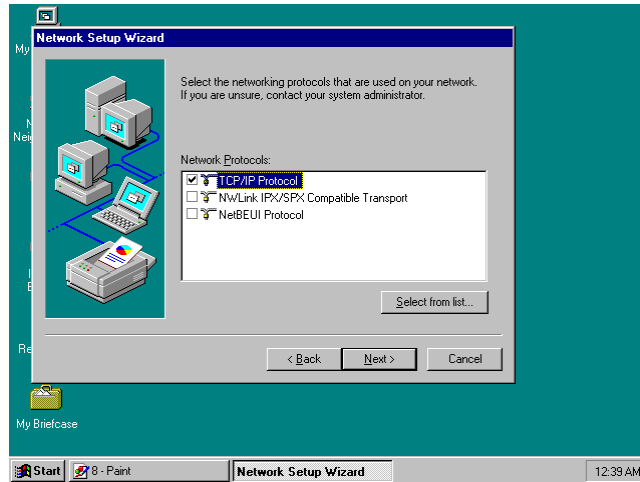

10. Before Setup starts installing the components found and the settings you made, it will give you the option to proceed or go back for changes from the following screen. Click on the Next button once you are sure of your devices.

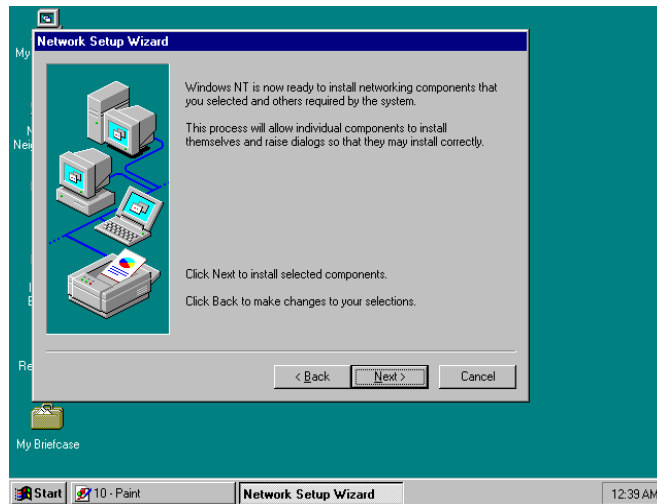

11. Windows NT Setup will then need to copy files necessary to update the system information. Specify the path then press Continue.

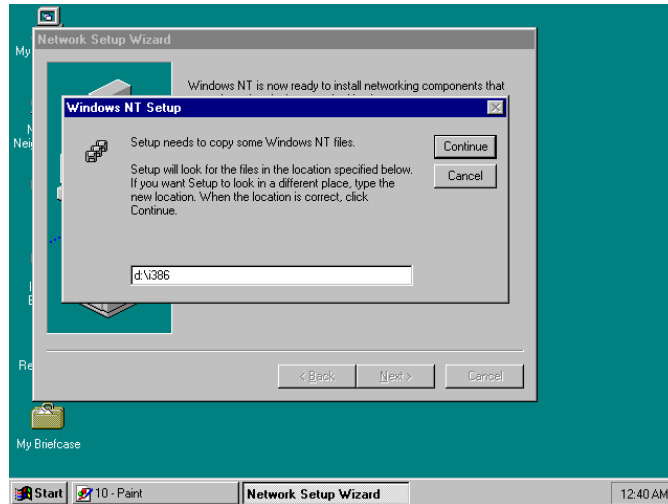

12. Once it finishes copying the files, Setup will now allow you to choose the Duplex Mode of your LAN controller. Press on the Continue button after making your selection.

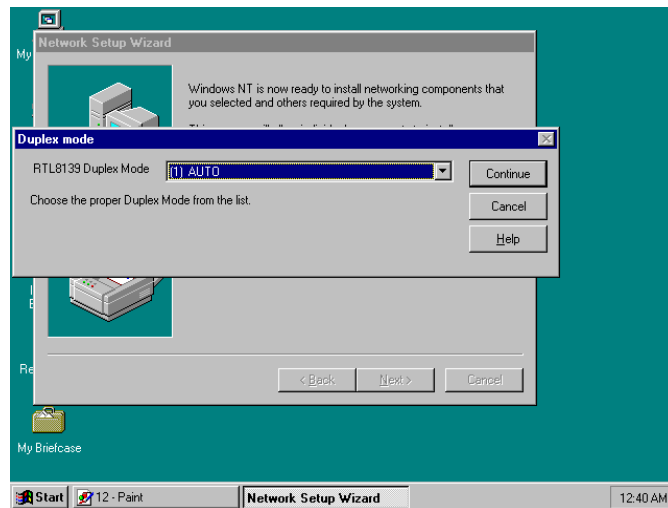

13. When Setup asks if you wish to change the TCP/IP settings of your system, select the appropriately. The default choice is No.

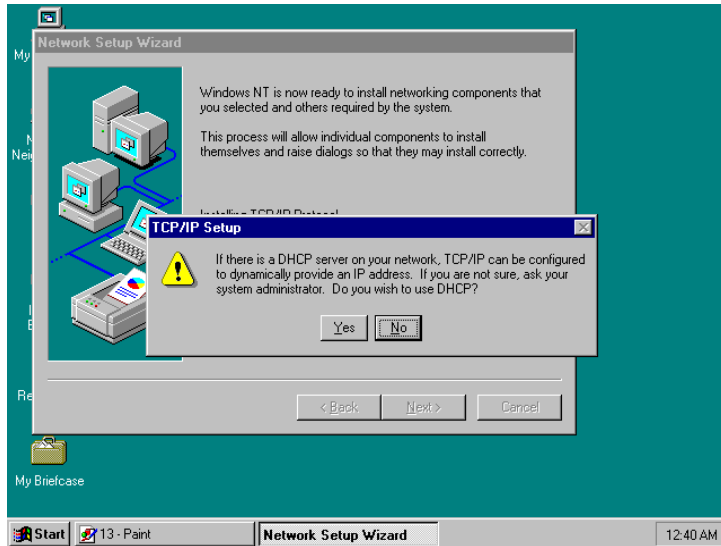

14. Setup then starts the Networking installation and copies the files.

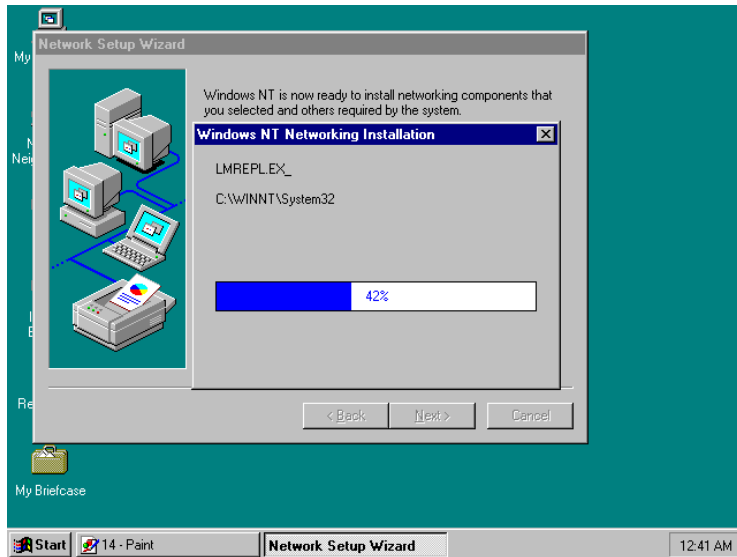

15. When Setup finishes copying, the TCP/IP properties of your system will then pop up on your screen like the one shown below. Make the necessary changes then click on OK to continue.

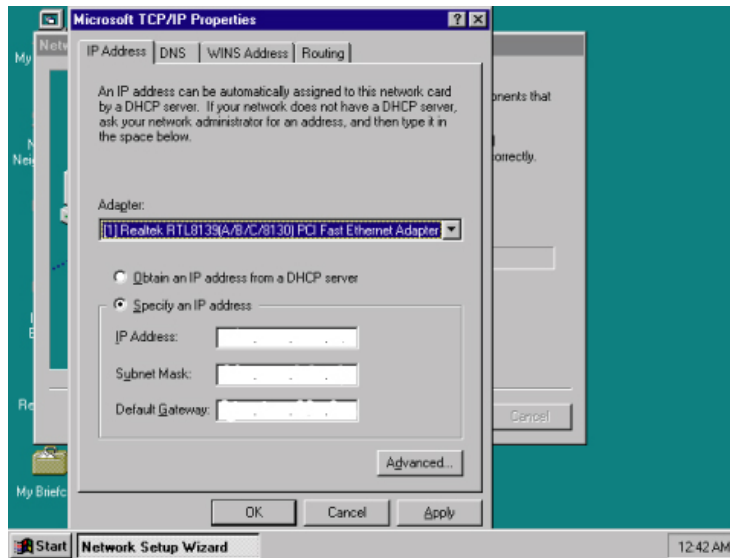

16. When the screen below appears, click on Next to continue.

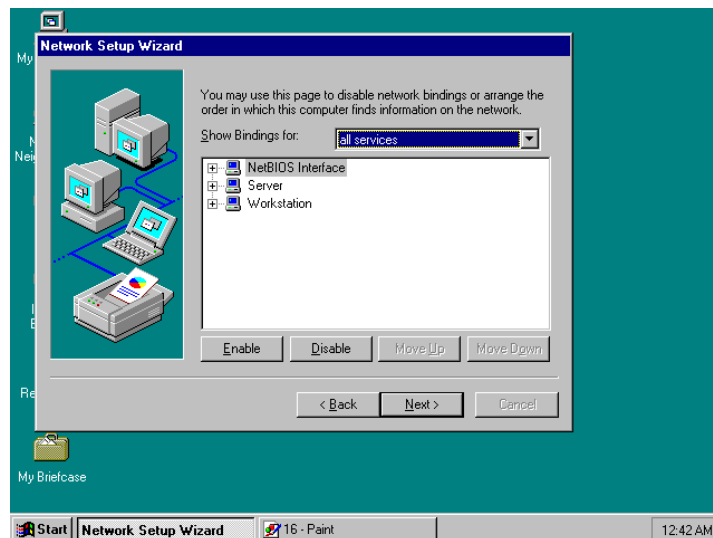

17. Setup then prompts you that it is ready to start the network. You may complete the installation thereafter. Click on Next to continue.

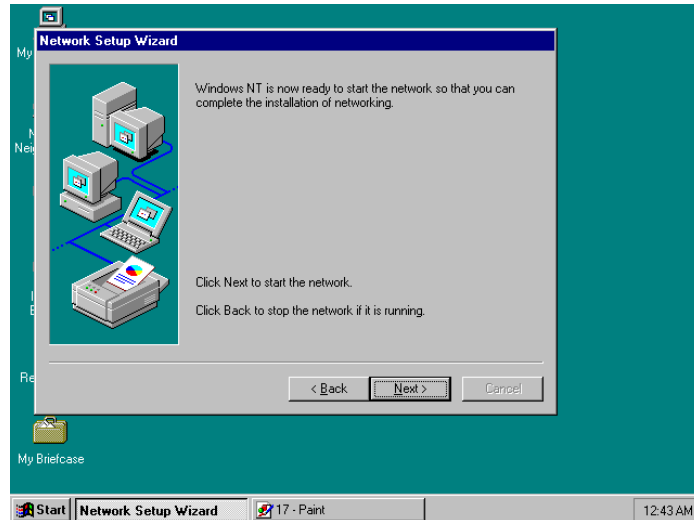

18. Assign the workgroup or domain setting of your computer. Click on Next to continue.

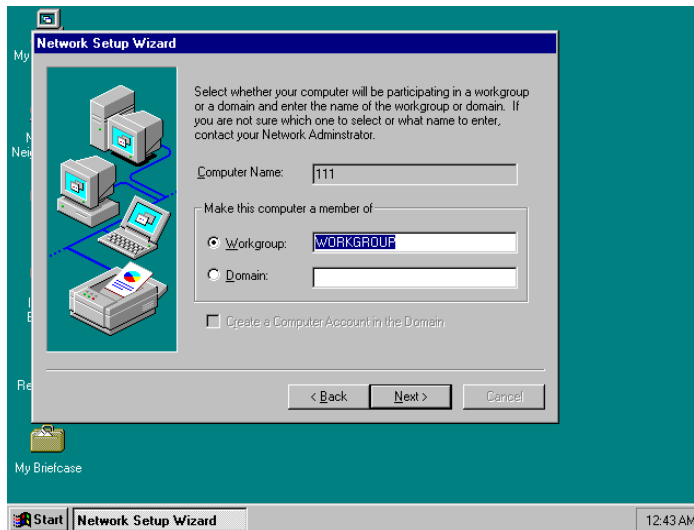

19. Restart your computer once the screen below appears. Click on Finish to continue.

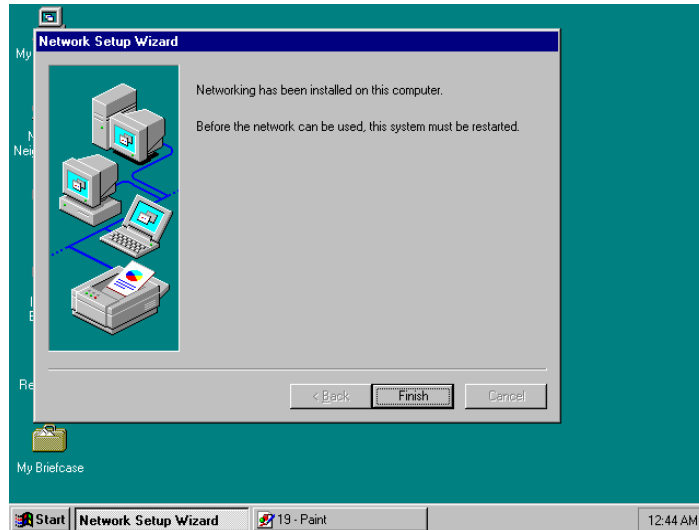

20. Click on the Yes button to restart your computer. The LAN driver installation for WIN NT4.0 is now complete.

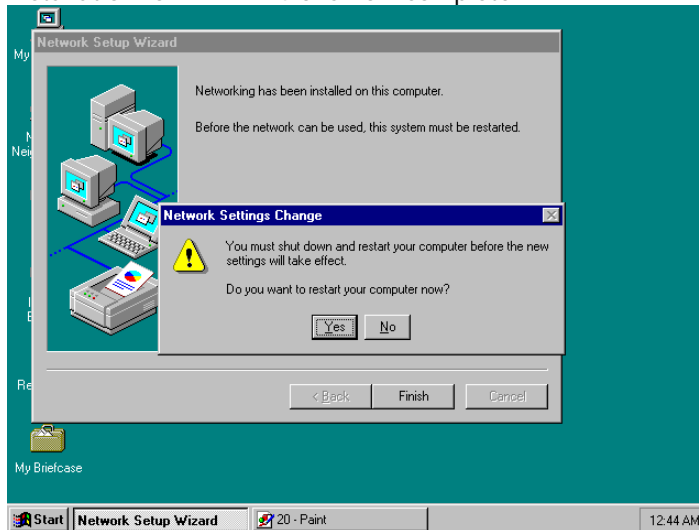

5.4 Audio Driver Installation

1. With the Utility CD Disk still in your CD ROM drive, open the File Manager and then select the CD-ROM drive. As soon as the system reads the disk, the VGA Menu screen below will appear on your display. Click on VIA_AC97 from the main menu.



2. Once the Welcome screen appears on the screen, make sure to close applications that are running and then click the Next button.

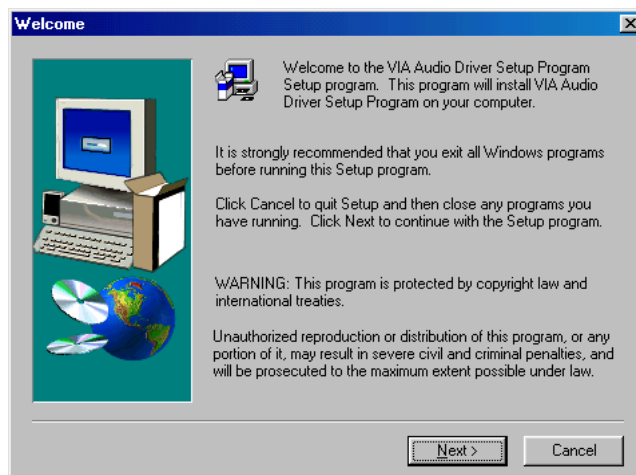

3. The Select Components dialog box is now displayed. Select on Install driver and then click on Next.

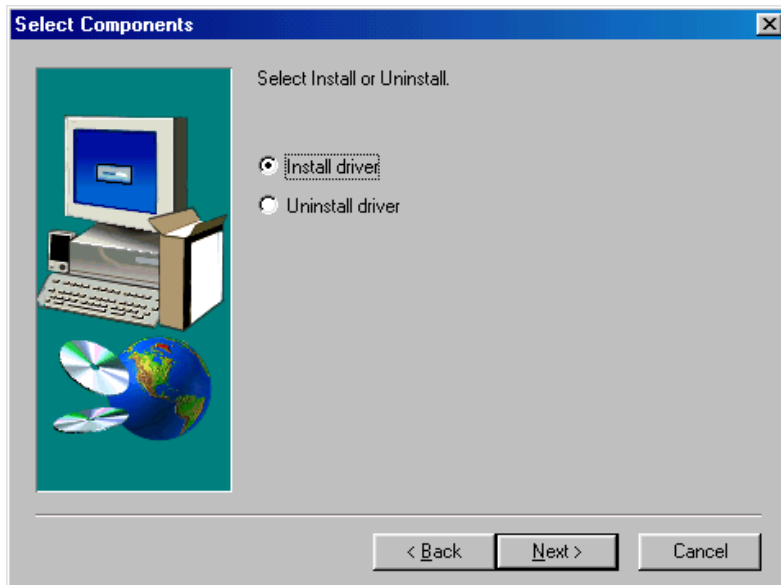

4. The program will now require the Windows installation disk for proper hardware installation. Insert the CD and then click on Next.

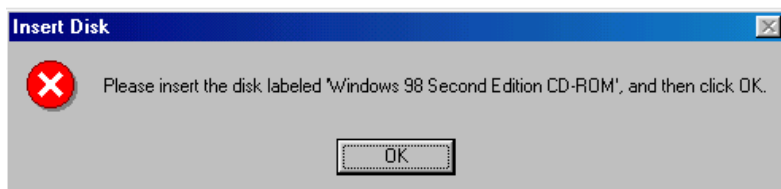

- When the display below appears on your screen, Setup is already installing and copying the related files onto your hard drive. Click on the Next button to proceed.

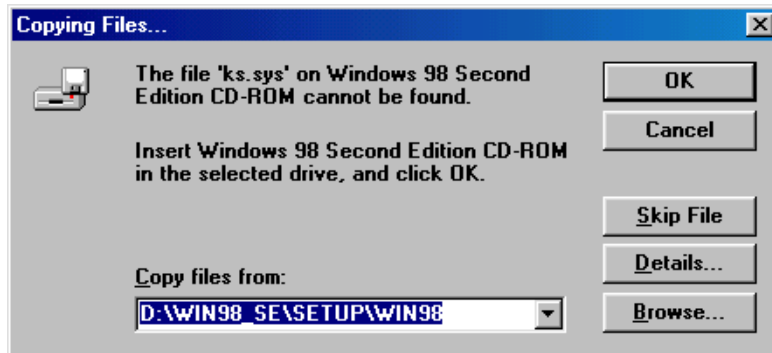

- After the audio driver installation finishes, select the Finish button to complete the installation process.

