

PLEASE CHECK WWW.MOLEX.COM FOR LATEST PART INFORMATION

Part Number: [0512424000](#)
Status: **Active**
Overview: microclasp
Description: 2.00mm (.079") Pitch MicroClasp™ Wire-to-Board Receptacle Housing, Positive Lock, Dual Row, With Terminal Retainer Option, 40 circuits

Documents:

[3D Model](#) [Product Specification PS-51242-002 \(PDF\)](#)
[Drawing \(PDF\)](#) [RoHS Certificate of Compliance \(PDF\)](#)
[Product Specification PS-51242-001 \(PDF\)](#)

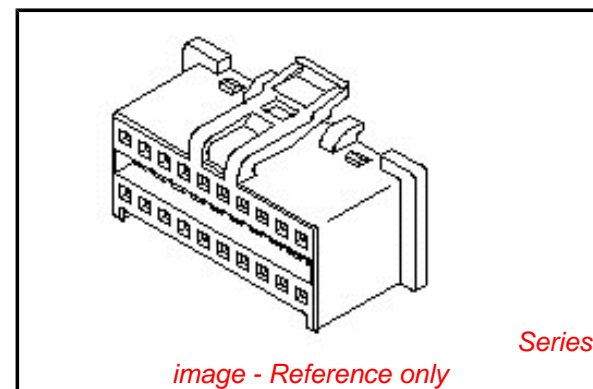

General

Product Family	Crimp Housings
Series	51242
Overview	microclasp
Product Name	MicroClasp™

Physical

Circuits (maximum)	40
Color - Resin	Natural
Gender	Female
Glow-Wire Compliant	No
Lock to Mating Part	Yes
Material - Resin	Nylon
Number of Rows	2
Packaging Type	Bag
Panel Mount	No
Pitch - Mating Interface (in)	0.079 In
Pitch - Mating Interface (mm)	2.00 mm
Stackable	No
Temperature Range - Operating	-25°C to +85°C

Material Info

Reference - Drawing Numbers

Product Specification	PS-51242-001, PS-51242-002, RPS-51242-003, RPS-51242-004, RPS-51242-005
Sales Drawing	SD-51242-002

EU RoHS

ELV and RoHS Compliant
REACH SVHC
 Not Reviewed
Halogen-Free
Status
Not Reviewed

China RoHS



Need more information on product environmental compliance?

Email productcompliance@molex.com
 For a multiple part number RoHS Certificate of Compliance, [click here](#)

Please visit the [Contact Us](#) section for any non-product compliance questions.

Search Parts in this Series

[51242Series](#)

Mates With

[55763](#)

Use With

[55767](#), [56134](#)

DWG. NO. SD-51242-002

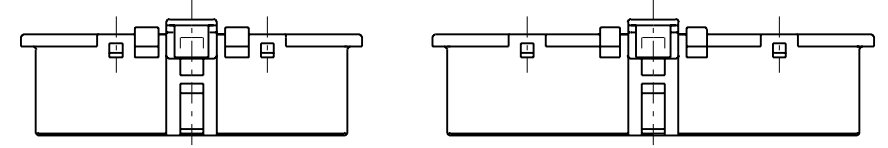
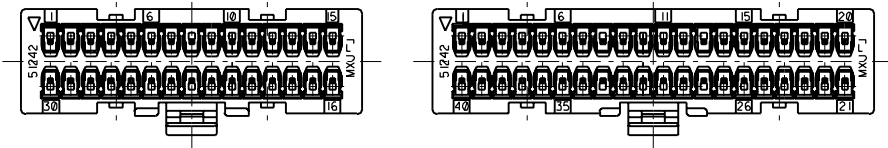
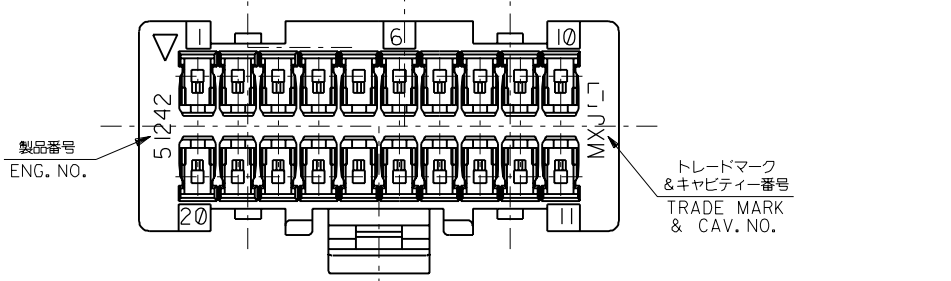

VIEW OF 30, 40 CIRCUIT (2:1)

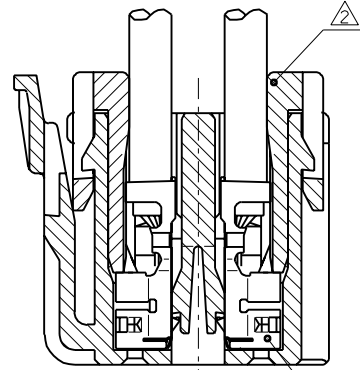
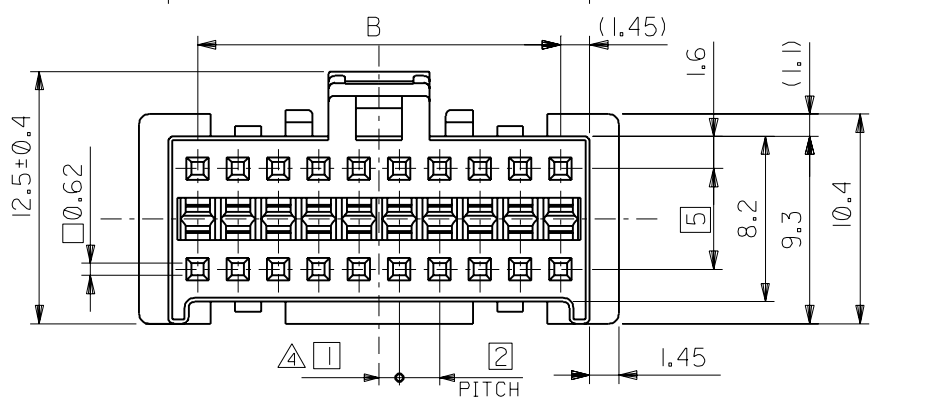
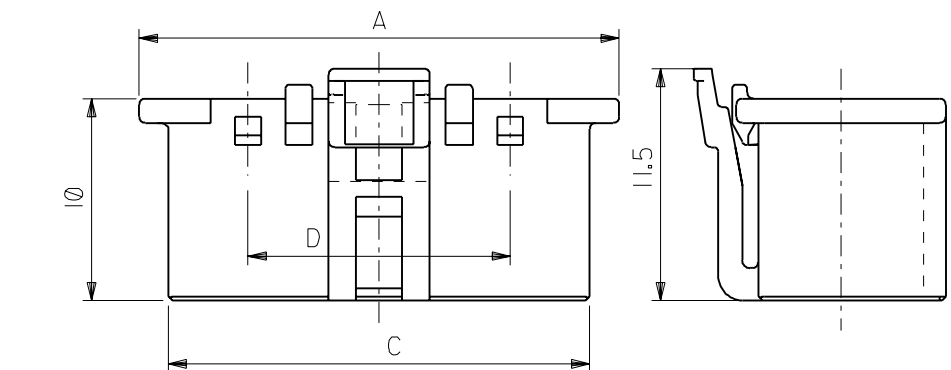

TERMINAL & RETAINER ASSEMBLY DRAWING SCALE 5:1

注記
NOTES

- △1 適合ターミナル : 56134シリーズ
APPLICABLE TERMINAL : 56134 SERIES
- △2 適合リテーナー : 55767シリーズ
APPLICABLE RETAINER : 55767 SERIES
- 3. 嵌合相手 : 55763シリーズ
MATE WITH : 55763 SERIES
(全極数/2) = 偶数の場合に適用。
APPLY FOR (CIRCUIT/2)=EVEN
- △5 製品番号
MATERIAL NO.

51242-**0*	ナチュラル(白) NATURAL(WHITE)	0
極数CIRCUIT SIZE	色COLOR	赤 RED
		2

25	40.9	38	43.8	51242-400*	40
15	30.9	28	33.8	51242-300*	30
13	20.9	18	23.8	51242-200*	20
D	C	B	A	△5 MATERIAL NO.	CKT.

DO NOT SCALE DRAWING

064NO. DRWN: CHK: APPR: 063NO. DRWN: CHK: APPR: 062NO. DRWN: CHK: APPR: REVISED 061NO. J2002-0125 DRWN: N.ITO '01/08/02 CHK: K.ASAKAWA APPR: T.YAMAGUCHI RELEASED 060NO. JC2001-0805 DRWN: N.ITO '01/04/02 CHK: T.YAMAGUCHI APPR: M.FUKUSHIMA	MATERIAL 材料 ポリアミド (PA66)、ガラス入り、 GLASS FILLED 66 NYLON, UL94V-0, 色: 表参照 COLOR: SEE CHART	GENERAL TOLERANCES: (UNLESS SPECIFIED) 一般公差 10 UNDER 未満 ±0.2 10 OVER 以上 30 UNDER 未満 ±0.25 30 OVER 以上 ±0.3 ANGLE 角度 ±3°	SCALE 4 : 1 DESIGN UNITS <input checked="" type="checkbox"/> mm <input type="checkbox"/> INCH PROJECTION <input checked="" type="checkbox"/> FIRST ANGLE <input type="checkbox"/> THIRD ANGLE	MODEL NO. 51242-**0* DIMENSIONS: <input type="checkbox"/> mm <input type="checkbox"/> INCH <input checked="" type="checkbox"/> mm ONLY SHT REV REVISE ON CAD ONLY	TITLE: 2.0mm W+B DUAL CONN RECEPTACLE HOUSING MOLEX MOLEX INCORPORATED	CAD FILENAME 51242002.S01 MATERIAL NO. SEE CHART DRAWING NO. SD-51242-002 SHEET NO. 1 OF 1