

HRPF0200 RELATIVE PRESSURE SENSOR (0-200kPa)

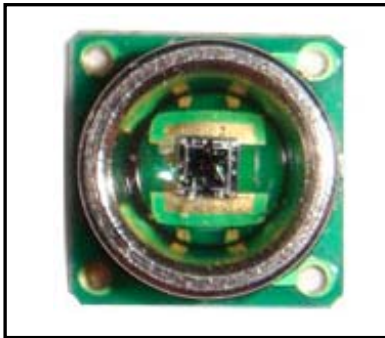

- 0 to 200kPa gage pressure range
- MEMS technique relative pressure sensor
- High sensitivity, high linearity
- Low cost SMD package
- RoHS-compatible & Pb-free

DESCRIPTION

The HRP series is a relative pressure sensor module, The design of the pressure sensor in the module is based on MEMS IC technology. The technology assures PN junction reverse current $< 10^{-10}$ A. The module has good linearity, sensitivity and high reliability.

FEATURES

- Uncompensated pressure sensor
- Temperature Range $-30^{\circ}\text{C} \sim +135^{\circ}\text{C}$
- Small size
- Low Cost, High reliability

APPLICATION

- breathing measurement
- pulse measurement
- high speed analysis for small amounts of material
- pressure switch
- environment control
- liquid level control
- Filter Blocked Sensor
- HVAC fan control
- leakage detection systems

Part number System

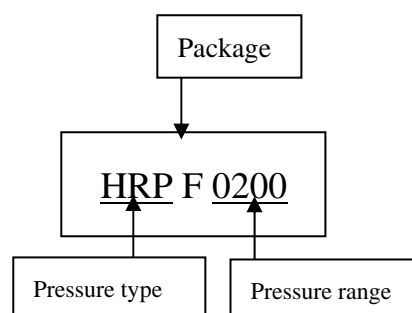

Electrical Characteristics

Item	Min	Typical	Max.	Unit
Pressure Range		30PSI		
Supply voltage	0	5.0	10.0	Volts
currency	0	1.5	3.0	mA
Span	70	100	130	mV
Offset	-30	0	30	mV
Temperature coefficient	-16	-22	-28	%FS/100°C
Temperature coefficient of Zero	-4	-6	-8	%FS/100°C
Nonlinearity	-0.2		+0.2	%F.S
Bridge resistance	4.0	5	6.0	K Ω
Proof pressure			2×	Rated FS
Operating temperature	-40		125	°C
Storage temperature	-40		125	°C

Pin Configuration (SMD Pressure sensor)

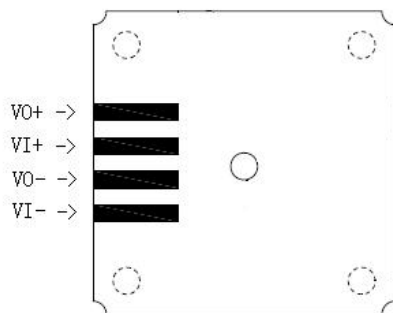

Bottom View

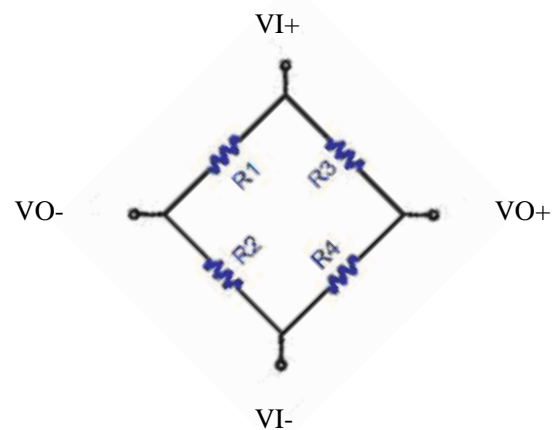

Pin	Name	Comment
1	VI-	GND
2	VO-	Negative output
3	VI+	Supply votage
4	VO+	Positive output

FR4 Package Outlines (all measures in mm)

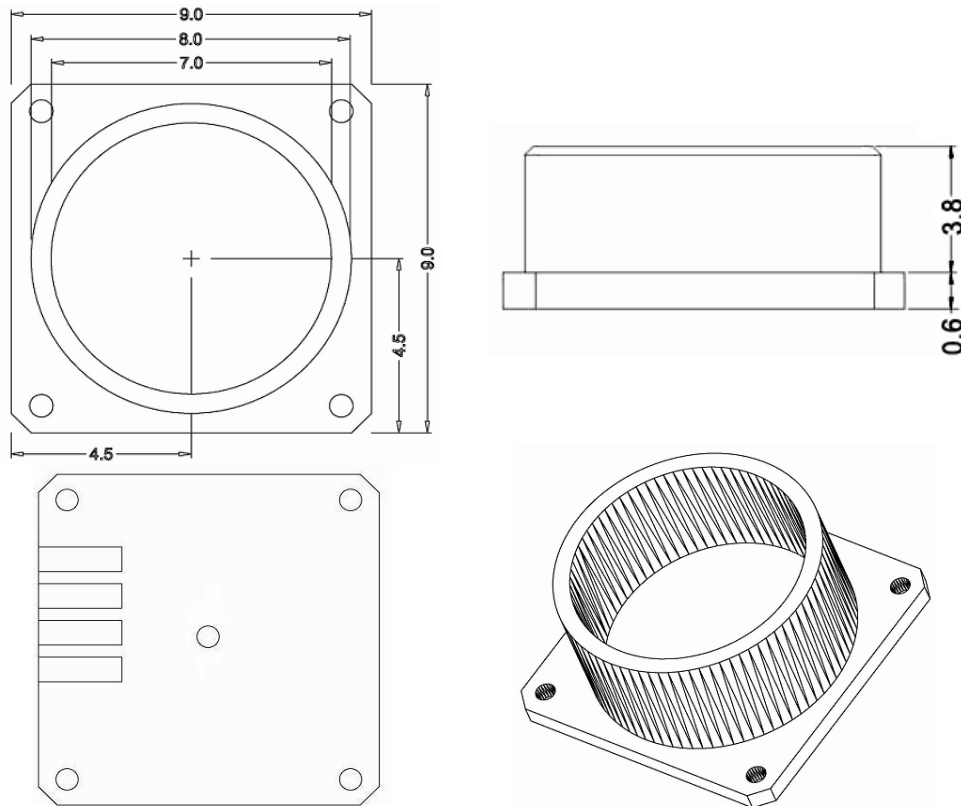

HOPE MICROELECTRONICS CO.,LTD

4/F, Block B3, East Industrial Area,
Huaqiaocheng, Shenzhen, Guangdong,
China

Tel: 86-755-82973805

Fax: 86-755-82973550

Email: sales@hoperf.com

Website: <http://www.hoperf.com>

<http://www.hoperf.cn>

<http://hoperf.en.alibaba.com>

This document may contain preliminary information and is subject to change by Hope Microelectronics without notice. Hope Microelectronics assumes no responsibility or liability for any use of the information contained herein. Nothing in this document shall operate as an express or implied license or indemnity under the intellectual property rights of Hope Microelectronics or third parties. The products described in this document are not intended for use in implantation or other direct life support applications where malfunction may result in the direct physical harm or injury to persons. NO WARRANTIES OF ANY KIND, INCLUDING, BUT NOT LIMITED TO, THE IMPLIED WARRANTIES OF MERCHANTABILITY OR FITNESS FOR A PARTICULAR PURPOSE, ARE OFFERED IN THIS DOCUMENT.

©2006, HOPE MICROELECTRONICS CO.,LTD. All rights reserved.