

### Description

GM6353 series is a group of positive voltage output, three-pin regulators, that provide a high current even when the input/output voltage differential is small. Low power consumption and high accuracy is achieved through CMOS and programmable fuse technologies, with the output voltage range from 1.5V to 6.0V

GM6353 consists of a high precision voltage reference, an error correction circuit, and a current limited output driver. Transient response to load variations has been improved in comparison to the existing series. The GM6353 incorporates both over temperature and over current protection.

### Features

- ◆ Maximum output current up 450mA
- ◆ Output voltage from 1.5V to 6.0V in 0.1V increments
- ◆ Output voltage accuracy :  $\pm 2\%$
- ◆ CMOS low power consumption, typically 15 $\mu$ A
- ◆ Input stability: typically 0.2%/V
- ◆ Ultra low dropout voltage, 0.1V @  $I_{OUT} = 100mA$

### Application

Palmtops

Portable Cameras

Video Recorders

Battery Powered Equipment

Reference Voltage Sources

### Typical Application Circuits

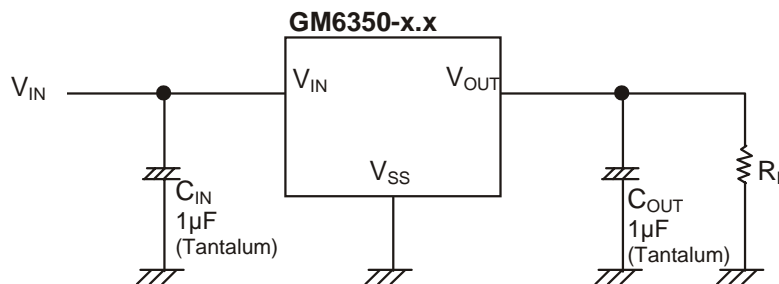

## Marking Information and Pin Configurations (Top View)

SOT223

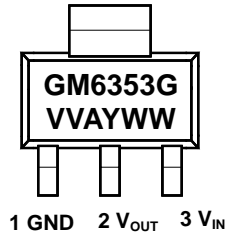

G: Green Product  
VV: Voltage suffix (18 = 1.8V, 50 = 5.0V...)  
A: Assembly / Test Site Code  
Y: Year  
WW: Week

## Ordering Information

Ordering Number	Output Voltage	Package	Shipping
GM6353-1.5ST3RG	1.5V	SOT-223	2,500 Units/Tape and Reel
GM6353-1.8ST3RG	1.8V	SOT-223	2,500 Units/Tape and Reel
GM6353-2.5ST3RG	2.5V	SOT-223	2,500 Units/Tape and Reel
GM6353-3.3ST3RG	3.3V	SOT-223	3,000 Units/Tape and Reel
GM6353-5.0ST3RG	5.0V	SOT-223	3,000 Units/Tape and Reel

### Absolute Maximum Ratings

PARAMETER	SYMBOL	RATINGS	UNITS
Input Voltage	$V_{IN}$	6.5	V
Output Current	$I_{OUT}$	450	mA
Output Voltage	$V_{OUT}$	$V_{SS} - 0.3$ to $V_{IN} + 0.3$	V
Thermal Resistance, Junction to Case	SOT-223 $\theta_{JA}$	15	$^{\circ}\text{C}/\text{W}$
Maximum Operating Junction Temperature	$T_J$	150	$^{\circ}\text{C}$
Operating Ambient Temperature	$T_A$	- 40 to 125	$^{\circ}\text{C}$
Storage Temperature	$T_{stg}$	- 65 to 150	$^{\circ}\text{C}$
Lead Temperature (Soldering, 10 sec)		+ 260	$^{\circ}\text{C}$

### Block Diagram

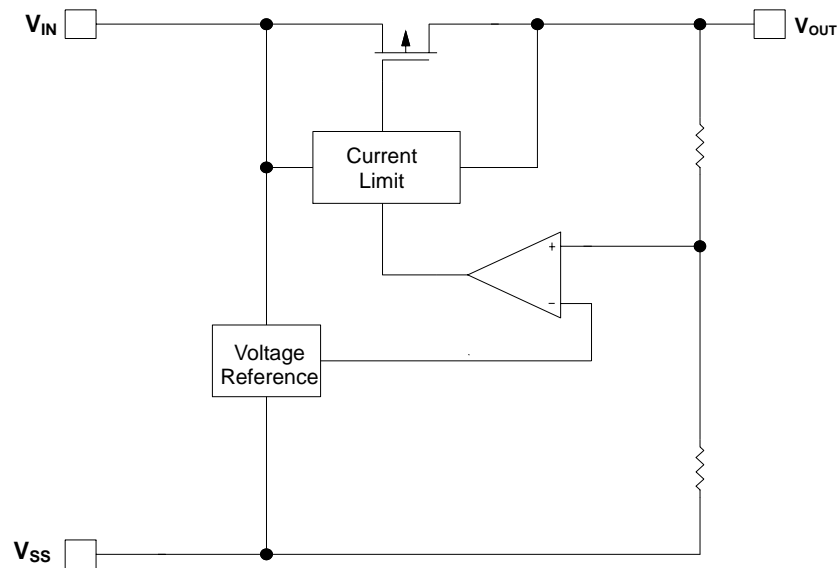

### Electrical Characteristics ( $T_A = 25^\circ\text{C}$ , $V_{IN} = V_{OUT} + 0.5\text{V}$ unless otherwise noted)

Parameter	Symbol	Condition	Min	Typ	Max	Unit	
Output Voltage Accuracy	$V_{OUT}$	$I_{OUT} = 1\text{mA}$	-1.4		+1.4	%	
		$I_{OUT} = 0.1\text{mA to } 300\text{mA}$	-3.0		+2.0		
Line Regulation	$\Delta V_{OI}$	$I_{OUT} = 1\text{mA}$ , $V_{OUT} + 0.1\text{V} < V_{IN} < 6.5\text{V}$ Fig. 1		0.1	0.3	%/V	
Load Regulation	$\Delta V_{OL}$	$V_{IN} = 6\text{V}$ , $0.1\text{mA} < I_{OUT} < 300\text{mA}$ $C_{OUT} = 1\mu\text{F}$ , Fig. 2		0.005	0.04	%/mA	
Maximum Output Current		$V_{IN} = 5\text{V}$ , $V_{OUT} > 0.96 \times V_{RATING}$	300	500		mA	
Output Current Limit	$I_{CL}$		400			mA	
Ground Pin Current	$I_{GND}$	Fig. 3		15	30	$\mu\text{A}$	
Dropout Voltage	$V_{OUT} > 2.5\text{V}$	$\Delta V$	$I_{OUT} = 100\text{mA}$		100	180	mV
			$I_{OUT} = 300\text{mA}$		300	550	
	$2.0\text{V} < V_{OUT} \leq 2.5\text{V}$		$I_{OUT} = 100\text{mA}$		150	300	
			$I_{OUT} = 300\text{mA}$		450	800	
	$V_{OUT} \leq 2.0\text{V}$		$I_{OUT} = 100\text{mA}$		200	400	
			$I_{OUT} = 300\text{mA}$		600	1100	
Power Supply Rejection Ration	PSRR	10kHz		60		dB	

Note: Load Regulation is measured using pulse techniques with duty cycle < 5%

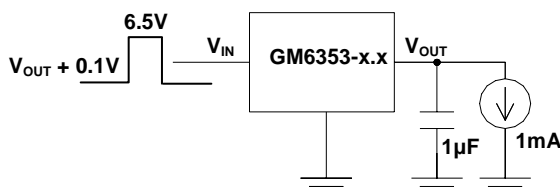

Figure 1. Line Regulation Test Circuit

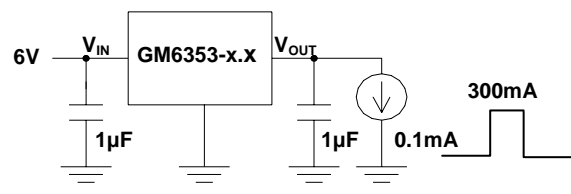

Figure 2. Load Regulation Test Circuit

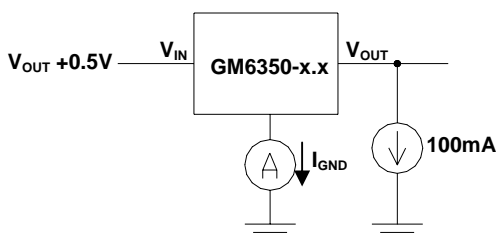
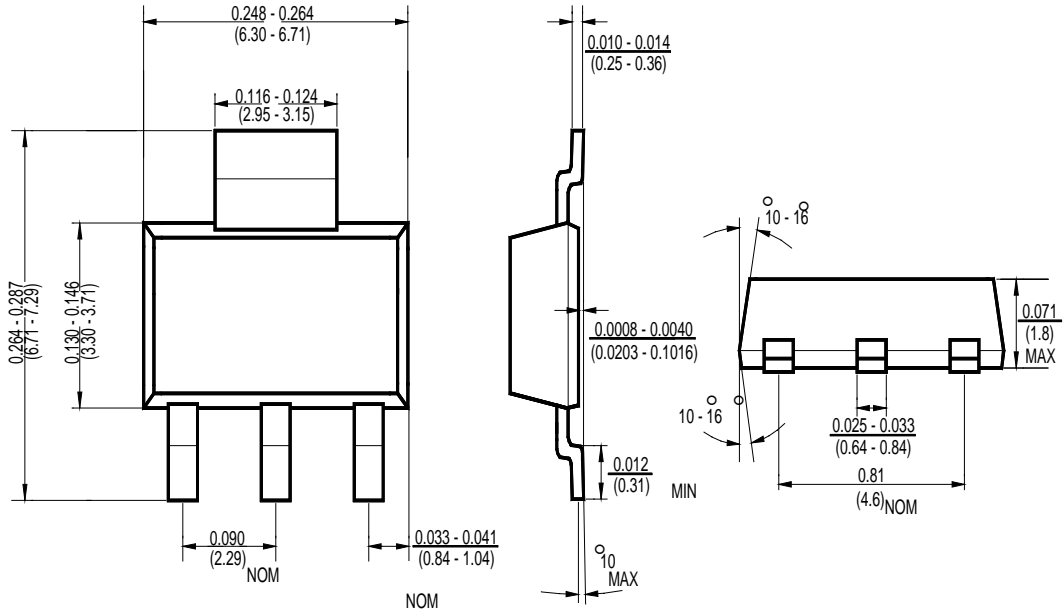

Figure 3. Ground Current Test Circuit

## Package Outline Dimensions – SOT 223



### Ordering Number

**GM 6353 - 1.5 ST3 R G**

APM Gamma Micro	Circuit Type	Output Voltage	Package Type	Shipping Type	
		1.5 = 1.5V 2.5 = 2.5V 3.3 = 3.3V 5.0 = 5.0V	ST3: SOT223	R: Tape & Reel	Blank: Pb-free G:Green

Note:

**Pb-free products:**

- ◆ RoHS compliant and compatible with the current requirements of IPC/JEDEC J-STD-020.
- ◆ Suitable for use in SnPb or Pb-free soldering processes with 100% matte tin (Sn) plating.

**Green products:**

- ◆ Lead-free (RoHS compliant)
- ◆ Halogen free (Br or Cl does not exceed 900ppm by weight in homogeneous material and total of Br and Cl does not exceed 1500ppm by weight)