

PLEASE CHECK WWW.MOLEX.COM FOR LATEST PART INFORMATION

Part Number: [0432026101](#)
Status: **Active**
Overview: [modular_plugs_jacks](#)
Description: Modular Jack, Right Angle, Low Profile, 6/6

Documents:

[3D Model](#) [Product Specification PS-43202-001 \(PDF\)](#)
[Drawing \(PDF\)](#) [RoHS Certificate of Compliance \(PDF\)](#)

Agency Certification

CSA LR19980
 UL E107635

General

Product Family Modular Jacks/Plugs
 Series [43202](#)
 Comments Enhanced panel grounding tabs
 Component Type PCB Jack
 Magnetic No
 Overview [modular_plugs_jacks](#)
 Performance Category 3, 4
 Power over Ethernet (PoE) N/A
 Product Name RJ11

Physical

Color - Resin Black
 Durability (mating cycles max) 500
 Flammability 94V-0
 Inverted / Top Latch No
 Lightpipes/LEDs None
 Material - Metal Phosphor Bronze
 Material - Plating Mating Gold
 Material - Plating Termination Tin
 Material - Resin High Temperature Thermoplastic
 Orientation Right Angle (Side Entry)
 PCB Retention Yes
 PCB Thickness Recommended (in) 0.062 In
 PCB Thickness Recommended (mm) 1.60 mm
 Packaging Type Tray
 Pitch - Mating Interface (in) 0.050 In
 Pitch - Mating Interface (mm) 1.27 mm
 Plating min: Mating (µin) 50
 Plating min: Mating (µm) 1.25
 Plating min: Termination (µin) 100
 Plating min: Termination (µm) 2.5
 Ports 1
 Positions / Loaded Contacts 6/6
 Surface Mount Compatible (SMC) Yes
 Temperature Range - Operating -40°C to +85°C
 Termination Interface: Style Through Hole
 Wire/Cable Type N/A

Electrical

Current - Maximum per Contact 1.5A
 Shielded No
 Voltage - Maximum 125V



EU RoHS

**ELV and RoHS
 Compliant**
**REACH SVHC
 Contains SVHC: No**
**Halogen-Free
 Status**

China RoHS



**Need more information on product
 environmental compliance?**

Email productcompliance@molex.com
 For a multiple part number RoHS Certificate of
 Compliance, [click here](#)

Please visit the [Contact Us](#) section for any
 non-product compliance questions.

Search Parts in this Series

[43202Series](#)

Mates With

FCC 68 Plugs

Solder Process Data

Duration at Max. Process Temperature (seconds)	5
Lead-free Process Capability	Wave Capable (TH only)
Max. Cycles at Max. Process Temperature	1
Process Temperature max. C	260

Material Info**Reference - Drawing Numbers**

Packaging Specification	PK-43202-003
Product Specification	PS-43202-001, RPS-43202-002
Sales Drawing	SDA-43202

This document was generated on 06/07/2010

PLEASE CHECK WWW.MOLEX.COM FOR LATEST PART INFORMATION



SHIELDED MODULAR JACK SHOWN WITH PANEL GROUND OPTION 'D' AND FRONT PCB GROUND TABS.

NOTES:

- 1) MATERIAL:
 - HOUSING: NYLON(PA), GLASS FILLED, UL94V-0, COLOR: SEE SHEETS 5 AND 6
 - INSULATOR: NYLON(PA), GLASS FILLED, UL94V-0, COLOR: SEE SHEETS 5 AND 6
 - TERMINALS: PHOSPHOR BRONZE, .012/ 0.30 THICK
 - SHIELD: BRASS, .007/ 0.18 THICK
- 2) FINISH:
 - TERMINALS:
 - A = SELECT GOLD IN CONTACT AREA: 50 MICROINCHES / 1.27 MICROMETERS MIN., *SELECT TIN IN PC TAIL AREA: 100 MICROINCHES / 2.54 MICROMETERS MIN., WITH OVERALL NICKEL UNDERPLATE: 50 MICROINCHES / 1.27 MICROMETERS MIN.
 - B = SELECT GOLD IN CONTACT AREA: 30 MICROINCHES / 0.76 MICROMETERS MIN., *SELECT TIN IN PC TAIL AREA: 100 MICROINCHES / 2.54 MICROMETERS MIN., WITH OVERALL NICKEL UNDERPLATE: 50 MICROINCHES / 1.27 MICROMETERS MIN.
 - *THE PRIMARY SHIPPING CARTON WILL BE LABELED "COMPLIANT TO RoHS DIRECTIVE 2002/95/EC AND ELV ANNEX II OF DIRECTIVE 2000/53/EC". CARTONS WITHOUT THIS LABEL MAY CONTAIN PRODUCT WITH TIN-LEAD IN THE PC TAILS AND/OR SHIELD.
 - SHIELD:
 - 100 MICROINCHES / 2.54 MICROMETERS NICKEL OVER 50 MICROINCHES / 1.27 MICROMETERS COPPER UNDERPLATE PCB GROUND TABS DIPPED IN TIN
- 3) PRODUCT SPECIFICATION AND PROCESSING PARAMETERS: PS-43202.
- 4) PACKAGING SPECIFICATION:
 - UNSHIELDED CONNECTOR ASSEMBLIES PACKAGED IN THERMOFORMED TRAYS PER MOLEX PACKAGING SPECIFICATION PK-43202-003.
 - UNSHIELDED CONNECTOR ASSEMBLIES PACKAGED IN TUBES PER MOLEX PACKAGING SPECIFICATION PK-43202-005.
 - SHIELDED CONNECTOR ASSEMBLIES PACKAGED IN THERMOFORMED TRAYS PER MOLEX PACKAGING SPECIFICATION PK-43202-004.
- 5) SEE SHEETS 7 - 9 FOR P.C. BOARD LAYOUTS.
- 6) CONFORMS TO FCC REGULATION PART 68.5 FOR MODULAR JACKS.
- 7) THIS PART CONFORMS TO CLASS B REQUIREMENTS OF COSMETIC SPECIFICATION PS-45499-002.

9	L2
8	L2
7	L2
6	L4
5	L
4	K2
3	L1
2	L1
1	L4
SH	REV

DRAWING LEGEND

- SHEET 1- NOTES, DRAWING LEGEND
- SHEET 2- SHIELDED MODULAR JACK W/ BOTTOM GROUND TABS
- SHEET 3- SHIELDED MODULAR JACK W/O BOTTOM GROUND TABS
- SHEET 4- UNSHIELDED MODULAR JACK
- SHEET 5- PART NUMBER CHARTS
- SHEET 6- PART NUMBER CHARTS
- SHEET 7- FOOTPRINT LAYOUT FOR 4 POSITION HOUSING
- SHEET 8- FOOTPRINT LAYOUT FOR 6 POSITION HOUSING
- SHEET 9- FOOTPRINT LAYOUT FOR 8 POSITION HOUSING

OBS COLORED JACKS EC NO: UCP2008-1189 DRAWN:JBELL 2007/11/30 CHKD:LSCHMIDT 2008/02/20 APPR:FSM1TH 2008/03/04	QUALITY SYMBOLS	GENERAL TOLERANCES (UNLESS SPECIFIED)		DIMENSION STYLE	SCALE	DESIGN UNITS	THIRD ANGLE PROJECTION	
	▼=0 ▽=0	mm	INCH	IN/MM	4:1	INCH		
		4 PLACES ± --- ± ---	3 PLACES ± --- ± .010	2 PLACES ± 0.25 ± .014	1 PLACE ± 0.36 ± ---	DRAWN BY DATE JTR 1993/03/31		TITLE ULTRA LOW PROFILE RIGHT ANGLE MODULAR JACK ASSEMBLY
		ANGULAR ±1/2°		APPROVED BY DATE RAS 1993/03/31		MATERIAL NO. DATE SEE SHTS 5&6 1993/03/31		
	DRAFT WHERE APPLICABLE MUST REMAIN WITHIN DIMENSIONS		MATERIAL NO.		DOCUMENT NO.		SHEET NO.	
L4	REV			THIS DRAWING CONTAINS INFORMATION THAT IS PROPRIETARY TO MOLEX INCORPORATED AND SHOULD NOT BE USED WITHOUT WRITTEN PERMISSION		SDA-43202		1 OF 9

UNSHIELDED MODULAR JACKS

SIZE 8, LOADED 10 SHOWN

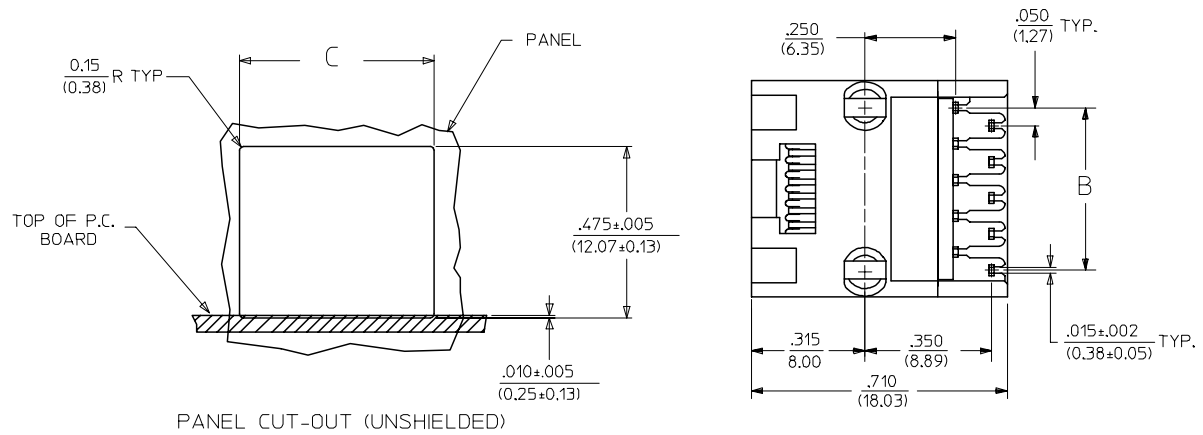
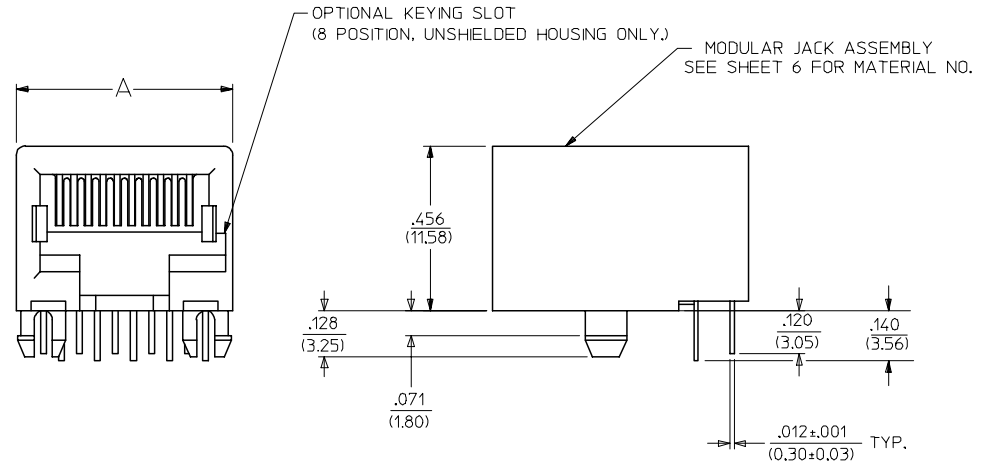

HOUSING SIZE	LOADED CIRCUITS	A	B	C
4	4	.440 (11.18)	.150±.005 (3.81±0.13)	.460±.005 (11.68±0.13)
4	2	.440 (11.18)	.050±.005 (1.27±0.13)	.460±.005 (11.68±0.13)
6	6	.520 (13.21)	.250±.005 (6.35±0.13)	.540±.005 (13.72±0.13)
6	4	.520 (13.21)	.150±.005 (3.81±0.13)	.540±.005 (13.72±0.13)
6	2	.520 (13.21)	.050±.005 (1.27±0.13)	.540±.005 (13.72±0.13)
8	10	.600 (15.24)	.450±.005 (11.43±0.13)	.620±.005 (15.75±0.13)
8	8	.600 (15.24)	.350±.005 (8.89±0.13)	.620±.005 (15.75±0.13)
8	6	.600 (15.24)	.250±.005 (6.35±0.13)	.620±.005 (15.75±0.13)
8	4	.600 (15.24)	.150±.005 (3.81±0.13)	.620±.005 (15.75±0.13)
8	2	.600 (15.24)	.050±.005 (1.27±0.13)	.620±.005 (15.75±0.13)

SEE SHEET ONE FC NO: UCP2004-1194 DRWN: L.SCHMIDT 2004/01/02 CHKD: L.SCHMIDT 2004/01/05 APPR: F.SMITH 2004/01/09 K2	QUALITY SYMBOLS ▽ - 0 ▽ - 0	GENERAL TOLERANCES (UNLESS SPECIFIED)		SCALE 4:1	DESIGN UNITS INCH	THIRD ANGLE PROJECTION	REVISE ON CAD ONLY	
		mm	INCH	DIMENSION STYLE		TITLE		
		4 PLACES ± --- ± ---	3 PLACES ± --- ± .010	IN/MM		ULTRA LOW PROFILE RIGHT ANGLE MODULAR JACK ASSEMBLY		
		2 PLACES ± 0.25 ± .014	1 PLACE ± 0.36 ± ---	ANGULAR ±1/2°				
DRAFT WHERE APPLICABLE MUST REMAIN WITHIN DIMENSIONS		DRAWN BY JTR	DATE 1993/03/31	CHECKED BY JTR	DATE 1993/03/31	MOLEX MOLEX INCORPORATED		
		APPROVED BY RAS	DATE 1993/03/31	MATERIAL NO. SEE SHT 6	DOCUMENT NO. SDA-43202	SHEET NO. 4 OF 9		



THIS DRAWING CONTAINS INFORMATION THAT IS PROPRIETARY TO MOLEX INCORPORATED AND SHOULD NOT BE USED WITHOUT WRITTEN PERMISSION

SHIELDED MODULAR JACKS W/O BOTTOM GROUND TABS (SHEET 3)

UNSHIELDED MODULAR JACKS- (SHEET 4)

ASSEMBLY MATERIAL NUMBER	CONNECTOR SIZE	NUMBER OF CIRCUITS	SIDE/TOP PANEL GROUND TAB OPTION	PCB GROUND TAB OPTION	TERMINAL PLATING OPTION	PACKAGING	HOUSING COLOR
43202-8800	8	10	E	FRONT POSITION	A	TRAY	BLACK
43202-8801	8	10	F	FRONT POSITION	A	TRAY	
43202-8802	8	10	G	FRONT POSITION	A	TRAY	
43202-8803	8	10	H	FRONT POSITION	A	TRAY	
43202-8808	8	10	E	REAR POSITION	A	TRAY	
43202-8809	8	10	F	REAR POSITION	A	TRAY	
43202-8810	8	10	G	REAR POSITION	A	TRAY	
43202-8811	8	10	H	REAR POSITION	A	TRAY	
43202-8816	8	8	E	FRONT POSITION	A	TRAY	
43202-8817	8	8	F	FRONT POSITION	A	TRAY	
43202-8818	8	8	G	FRONT POSITION	A	TRAY	
43202-8819	8	8	H	FRONT POSITION	A	TRAY	
43202-8824	8	8	E	REAR POSITION	A	TRAY	
43202-8825	8	8	F	REAR POSITION	A	TRAY	
43202-8826	8	8	G	REAR POSITION	A	TRAY	
43202-8827	8	8	H	REAR POSITION	A	TRAY	

ASSEMBLY MATERIAL NUMBER	CONNECTOR SIZE	NUMBER OF CIRCUITS	TERMINAL PLATING OPTION	KEYING OPTION	PACKAGING OPTION	HOUSING COLOR
43202-4101	4	4	A	NO	TRAY	BLACK
43202-4104	4	2	A	NO	TRAY	
43202-6101	6	6	A	NO	TRAY	
43202-6102	6	6	B	NO	TRAY	
43202-6104	6	4	A	NO	TRAY	
43202-6105	6	4	B	NO	TRAY	
43202-6107	6	2	A	NO	TRAY	
43202-6110	6	6	B	NO	TUBE	
43202-8101	8	10	A	NO	TRAY	
43202-8104	8	8	A	NO	TRAY	
43202-8105	8	8	B	NO	TRAY	
43202-8113	8	8	A	YES	TRAY	
43202-8116	8	6	A	NO	TRAY	
43202-8119	8	4	A	NO	TRAY	
43202-8122	8	2	A	NO	TRAY	
43202-8504	8	8	A	NO	TUBE	
43202-8513	8	8	A	YES	TUBE	

OBS COLORED JACKS EC NO: UCP2008-1189 DRWN:JBELL 2007/11/30 CHKD:LSCHMIDT 2008/02/20 APPR:FSM/TH 2008/03/04	QUALITY SYMBOLS  = 0  = 0.010	GENERAL TOLERANCES (UNLESS SPECIFIED)		DIMENSION STYLE IN/MM		SCALE 4:1	DESIGN UNITS INCH	 THIRD ANGLE PROJECTION		
		4 PLACES ± --- ± ---	3 PLACES ± --- ± .010	2 PLACES ± 0.25 ± .014	1 PLACE ± 0.36 ± ---	APPROVED BY BW	DATE 2000/10/03	TITLE ULTRA LOW PROFILE RIGHT ANGLE MODULAR JACK ASSEMBLY		
		ANGULAR ± 1/2°				MATERIAL NO. SEE CHART		DOCUMENT NO. SDA-43202		SHEET NO. 6 OF 9
		DRAFT WHERE APPLICABLE MUST REMAIN WITHIN DIMENSIONS				THIS DRAWING CONTAINS INFORMATION THAT IS PROPRIETARY TO MOLEX INCORPORATED AND SHOULD NOT BE USED WITHOUT WRITTEN PERMISSION				

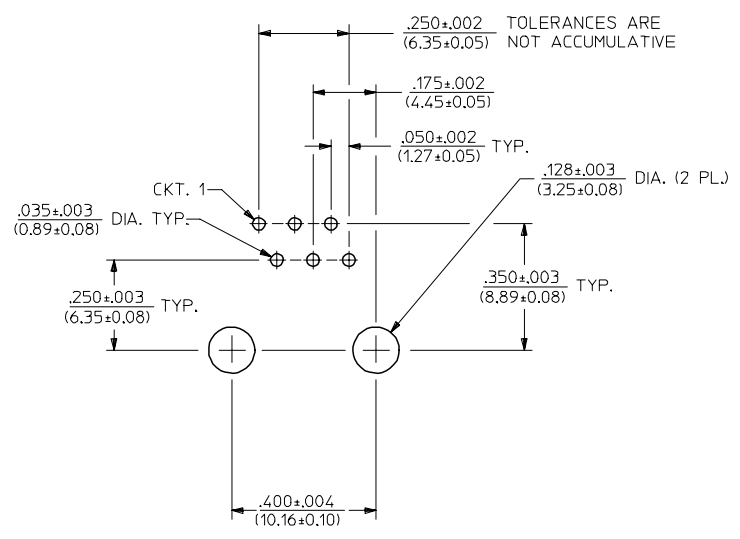

PC BOARD LAYOUT FOR 6 POSITION HOUSING
(6 CIRCUIT FOOT PRINT SHOWN)
(COMPONENT SIDE OF BOARD)

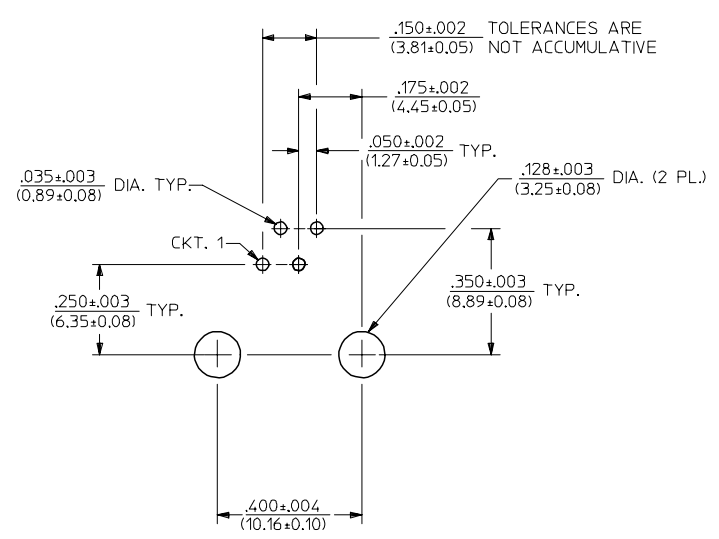

PC BOARD LAYOUT FOR 6 POSITION HOUSING
(4 CIRCUIT FOOT PRINT SHOWN)
(COMPONENT SIDE OF BOARD)

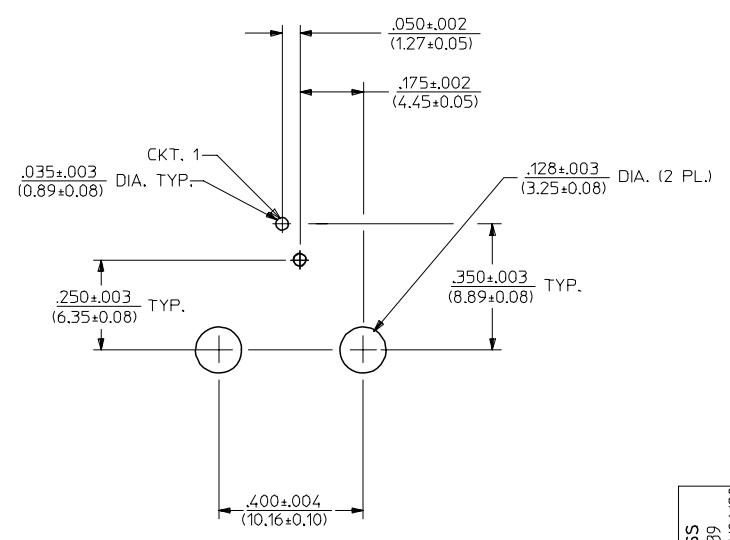

PC BOARD LAYOUT FOR 6 POSITION HOUSING
(2 CIRCUIT FOOT PRINT SHOWN)
(COMPONENT SIDE OF BOARD)

NOTES:
1. RECOMMENDED PCB THICKNESS: .062±.005/(1.57±0.13)

ADD PCB THICKNESS EC NO: UCP2005-2739 DRWN:L.SCHMIDT 2005/06/20 CHKD:ELHAG 2005/06/22 APPR:FSMITH 2005/06/23 REV L2	QUALITY SYMBOLS	GENERAL TOLERANCES (UNLESS SPECIFIED)	SCALE 4:1	DESIGN UNITS INCH	THIRD ANGLE PROJECTION	REVISE ON CAD ONLY	
	▽ - 0 ▽ - 0	mm	INCH	DIMENSION STYLE IN/MM	TITLE		
		4 PLACES ± --- ± ---	± .010	DRAWN BY L.E.LENZ	DATE 1995/03/09	ULTRA LOW PROFILE RIGHT ANGLE MODULAR JACK ASSEMBLY	
		3 PLACES ± --- ± ---	± .014	CHECKED BY JTR	DATE 1995/03/09	MOLEX MOLEX INCORPORATED	
	2 PLACES ± 0.25 ± ---	± .014	APPROVED BY RAS	DATE 1995/03/09	MATERIAL NO. SEE SHT 6	DOCUMENT NO. SDA-43202	
	1 PLACE ± 0.36 ± ---	± ---	DRAFT WHERE APPLICABLE MUST REMAIN WITHIN DIMENSIONS		SHEET NO. 8 OF 9		
		ANGULAR ±1/2°	THIS DRAWING CONTAINS INFORMATION THAT IS PROPRIETARY TO MOLEX INCORPORATED AND SHOULD NOT BE USED WITHOUT WRITTEN PERMISSION				