

PLEASE CHECK WWW.MOLEX.COM FOR LATEST PART INFORMATION

Part Number: [0753414647](#)
Status: **Active**
Overview: [gbx_backplane_connector_system](#)
Description: 1.85mm by 1.85mm (.073 by .073") Pitch 4-Pair GbX® Backplane Connector System, Power Module, 12 Circuits, 1.27µm (50µ") Gold (Au)

Documents:

[Drawing \(PDF\)](#) [RoHS Certificate of Compliance \(PDF\)](#)
[Product Specification PS-75221-999 \(PDF\)](#)

Agency Certification

UL E29179

General

Product Family Backplane Connectors
 Series [75341](#)
 Application Backplane
 Application Tooling Documents [Tooling Manual](http://www.molex.com/pdm_docs/ats/TM-622022099.pdf)
 Comments Blade Length A 4.50mm, B 6.00mm, C 4.50mm, D 7.0mm
 Component Type Power Header
 Overview [gbx_backplane_connector_system](#)
 Product Name GbX®
 Style N/A

Physical

Circuits (Loaded) 8
 Circuits (maximum) 8
 Circuits Detail Rows A, B, C, & D
 Color - Resin Gray
 Durability (mating cycles max) 200
 First Mate / Last Break Yes
 Flammability 94V-0
 Guide to Mating Part No
 Keying to Mating Part None
 Material - Plating Mating Gold
 Material - Plating Termination Tin-Lead
 Material - Resin High Temperature Thermoplastic
 Number of Columns N/A
 Number of Pairs 4
 Number of Rows 4
 Orientation Vertical
 PC Tail Length (in) 0.089 In
 PC Tail Length (mm) 2.28 mm
 PCB Locator Yes
 PCB Retention Yes
 PCB Thickness Recommended (in) 0.063 In
 PCB Thickness Recommended (mm) 1.60 mm
 Packaging Type Tube
 Pitch - Mating Interface (in) 0.073 In
 Pitch - Mating Interface (mm) 1.85 mm
 Pitch - Term. Interface (in) 0.102 In
 Pitch - Term. Interface (mm) 2.60 mm
 Plating min: Mating (µin) 50
 Plating min: Mating (µm) 1.25

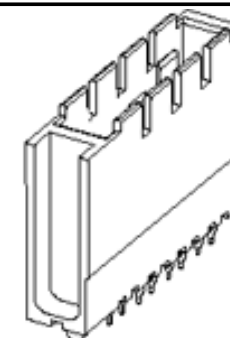

image - Reference only

Series

EU RoHS

RoHS Compliant by Exemption

REACH SVHC

Not Reviewed

Halogen-Free

Status

Not Reviewed

China RoHS



Need more information on product environmental compliance?

Email productcompliance@molex.com
 For a multiple part number RoHS Certificate of Compliance, [click here](#)

Please visit the [Contact Us](#) section for any non-product compliance questions.

Search Parts in this Series

[75341Series](#)

Mates With

[75292 GbX® Daughtercard](#)

Application Tooling | FAQ

Tooling specifications and manuals are found by selecting the products below. Crimp Height Specifications are then contained in the Application Tooling Specification document.

Global

Description	Product #
Insertion Module, GbX® 4 pair 1- Up Power Module	0622022005
GbX® Single Pin Repair Tool	0622022090
GbX® Shield Removal Tool	0622022100

Plating min: Termination (μ in)	30
Plating min: Termination (μ m)	0.75
Polarized to PCB	Yes
Stackable	No
Surface Mount Compatible (SMC)	Yes
Temperature Range - Operating	-55°C to +105°C
Termination Interface: Style	Through Hole - Compliant Pin

Electrical

Current - Maximum per Contact	6A
Data Rate	8.0 Gbps
Real Signals (per 25mm)	0
Shielded	No
Voltage - Maximum	120V AC (RMS)/DC

Material Info

Reference - Drawing Numbers

Product Specification	PS-75221-999
Sales Drawing	SD-75341-001

GbX is a registered trademark of Amphenol Corporation.

This document was generated on 05/13/2010

PLEASE CHECK WWW.MOLEX.COM FOR LATEST PART INFORMATION

10 9 8 7 6 5 4 3 2 1



NOTES:

1. MATERIALS: HOUSING - LIQUID CRYSTAL POLYMER (LCP), UL 94V-0, GRAY; CONTACT - COPPER ALLOY.
2. FINISH: SELECT GOLD IN CONTACT AREA, 50 μ" THICK; TIN/LEAD OR MATTE TIN IN COMPLIANT AREA.
3. PACKAGING PER PK-70873-562.
4. CONTACTS IN EACH ROW HAVE THE SAME WIPE LENGTH.
5. BACKPLANE ASSEMBLY MATES WITH DAUGHTERCARD POWER MODULE 75292-4***.
6. PART SHOWN IS 75343-4467 (SHEET 4).
7. SEE OTHER SHEETS FOR ADDITIONAL NOTES.
8. WHEN INSERTING OPEN SIGNAL MODULES NEXT TO COLUMN 1 SIDE OF POWER MODULES, SIGNAL MODULES MUST BE INSERTED BEFORE THE POWERS TO AVOID INTERFERENCE BETWEEN THE TWO CONNECTOR HOUSINGS.
9. THESE PARTS CONFORM TO MOLEX PRODUCT SPECIFICATION PS-75221-999.
10. THESE PARTS CONFORM TO MOLEX COSMETIC SPECIFICATION PS-45499-002 CLASS B.

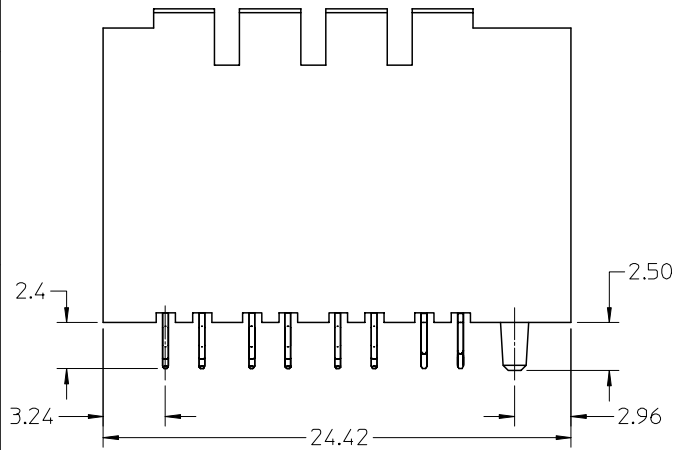

1-UP ASSEMBLY PART NUMBER

7 5 3 4 1 - A B C D
 - TIN/LEAD PLATED PRODUCT -
 FOR EACH ROW LOCATION A, B, C, D:
 0 = VOID
 4 = 4.5 mm WIPE
 6 = 6.0 mm WIPE
 7 = 7.5 mm WIPE
 - LEAD-FREE PLATED PRODUCT -
 FOR EACH ROW LOCATION A, B, C, D:
 0 = VOID
 2 = 4.5 mm WIPE
 3 = 6.0 mm WIPE
 5 = 7.5 mm WIPE

ADDED NOTES 9 & 10
 EC NO: UCP2008-0426
 DRAWN: C STEWART 2007/08/29
 CHKD: 2007/08/30
 APPR: J B INGHAM 2007/08/31

QUALITY SYMBOLS	DESCRIPTION
▽=0	
▽=0	
REV	

GENERAL TOLERANCES (UNLESS SPECIFIED)	
	mm INCH
4 PLACES	±--- ±---
3 PLACES	±--- ±---
2 PLACES	±--- ±---
1 PLACE	±--- ±---
ANGULAR ±---°	
DRAFT WHERE APPLICABLE MUST REMAIN WITHIN DIMENSIONS	

DIMENSION STYLE	
MM ONLY	
DRAWN BY	DATE
ELO	2006/04/06
CHECKED BY	DATE
ELO	2005/02/22
APPROVED BY	DATE
CUNNINGHAM	2005/02/23
MATERIAL NO.	
SEE CHART	

SCALE	4:1
DESIGN UNITS	METRIC
THIRD ANGLE PROJECTION	

TITLE	
GBX 4 PAIR BACKPLANE POWER SALES ASSEMBLY	
MOLEX MOLEX INCORPORATED	
DOCUMENT NO.	SHEET NO.
SD-75341-001	1 OF 4

9 8 7 6 5 4 3 2 1

10 9 8 7 6 5 4 3 2 1



2-UP ASSEMBLY PART NUMBER

7 5 3 4 2 - A B C D

- TIN/LEAD PLATED PRODUCT -
FOR EACH ROW LOCATION A, B, C, D:

- 0 = VOID
- 4 = 4.5 mm WIPE
- 6 = 6.0 mm WIPE
- 7 = 7.5 mm WIPE

- LEAD-FREE PLATED PRODUCT -
FOR EACH ROW LOCATION A, B, C, D:

- 0 = VOID
- 2 = 4.5 mm WIPE
- 3 = 6.0 mm WIPE
- 5 = 7.5 mm WIPE



SEE SHEET 1 FOR ADDITIONAL INFORMATION
CHECK WITH PRODUCT MANAGER FOR AVAILABILITY

SEE SHEET ONE EC NO: UCP2008-0426 DRW: JSTEWART 2007/08/29 CHKD: 2007/08/30 APPR: J. INGHAM 2007/08/31	QUALITY SYMBOLS ▽=0 ▽=0	GENERAL TOLERANCES (UNLESS SPECIFIED)		DIMENSION STYLE MM ONLY		SCALE 4:1	DESIGN UNITS METRIC	THIRD ANGLE PROJECTION	
		4 PLACES ± --- ± ---	3 PLACES ± --- ± ---	DRAWN BY ELO	DATE 2006/04/06	TITLE GBX 4 PAIR BACKPLANE POWER SALES ASSEMBLY			
		2 PLACES ± --- ± ---	1 PLACE ± --- ± ---	CHECKED BY ELO	DATE 2005/02/22				
		ANGULAR ± --- °		APPROVED BY CUNNINGHAM	DATE 2005/02/23	MATERIAL NO. SEE CHART		DOCUMENT NO. SD-75341-001	
DRAFT WHERE APPLICABLE MUST REMAIN WITHIN DIMENSIONS		THIS DRAWING CONTAINS INFORMATION THAT IS PROPRIETARY TO MOLEX INCORPORATED AND SHOULD NOT BE USED WITHOUT WRITTEN PERMISSION							

9 8 7 6 5 4 3 2 1



COLUMN 1
 COLUMN 2
 COLUMN 3
 COLUMN 4
 COLUMN 5
 COLUMN 6

3-UP ASSEMBLY PART NUMBER
 7 5 3 4 3 - A B C D
 - TIN/LEAD PLATED PRODUCT -
 FOR EACH ROW LOCATION A, B, C, D:
 0 = VOID
 4 = 4.5 mm WIPE
 6 = 6.0 mm WIPE
 7 = 7.5 mm WIPE
 - LEAD-FREE PLATED PRODUCT -
 FOR EACH ROW LOCATION A, B, C, D:
 0 = VOID
 2 = 4.5 mm WIPE
 3 = 6.0 mm WIPE
 5 = 7.5 mm WIPE

SEE NOTE 4.

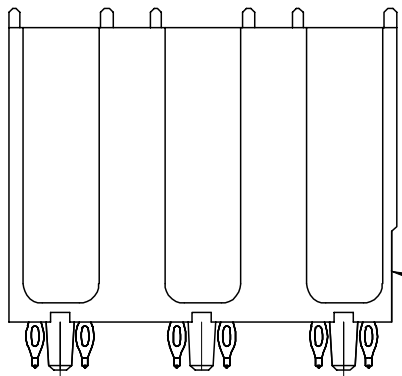

SEE NOTE 8.

14.80

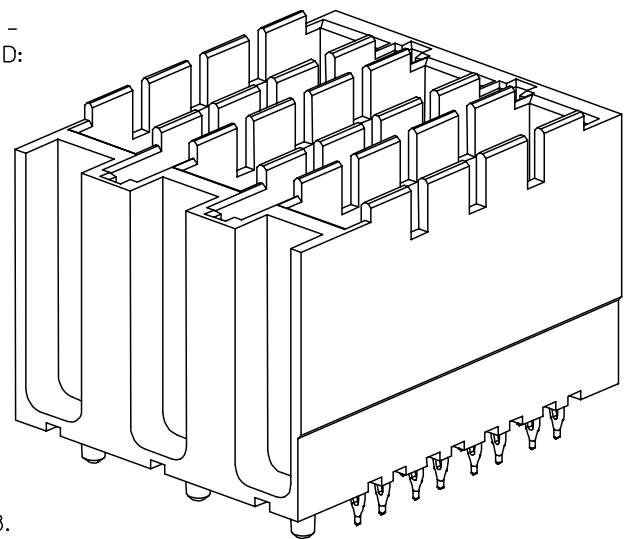

SEE SHEET 1 FOR ADDITIONAL INFORMATION
 CHECK WITH PRODUCT MANAGER FOR AVAILABILITY

SEE SHEET ONE EC NO: UCP2008-0426 DRW: JSTEWART 2007/08/29 CHKD: 2007/08/30 APPR: J. INGHAM 2007/08/31	QUALITY SYMBOLS ▽=0 ▽=0	GENERAL TOLERANCES (UNLESS SPECIFIED)		DIMENSION STYLE MM ONLY		SCALE 4:1	DESIGN UNITS METRIC	THIRD ANGLE PROJECTION	
			mm	INCH	DRAWN BY ELO	DATE 2006/04/06	TITLE GBX 4 PAIR BACKPLANE POWER SALES ASSEMBLY		
		4 PLACES ± ---	± ---	± ---	CHECKED BY ELO	DATE 2005/02/22	APPROVED BY CUNNINGHAM		
		3 PLACES ± ---	± ---	± ---	DATE 2005/02/23	DOCUMENT NO. SD-75341-001			
			2 PLACES ± ---	± ---	± ---	MATERIAL NO.		SHEET NO.	
			1 PLACE ± ---	± ---	± ---	SEE CHART		3 OF 4	
			ANGULAR ± ---°		DRAFT WHERE APPLICABLE MUST REMAIN WITHIN DIMENSIONS		THIS DRAWING CONTAINS INFORMATION THAT IS PROPRIETARY TO MOLEX INCORPORATED AND SHOULD NOT BE USED WITHOUT WRITTEN PERMISSION		

10 9 8 7 6 5 4 3 2 1

SEE NOTE 5.

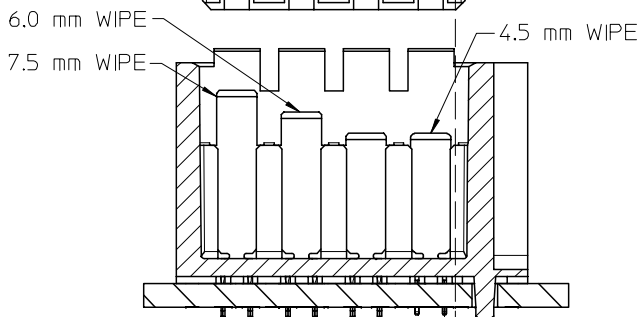

0.76
DC BOARD EDGE TO
CENTERLINE OF BP TAIL

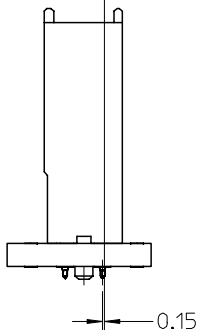

HOLE PATTERN FOR 1-UP ASSEMBLY

- 1.) ADD 7.40 FROM CENTERLINES OF PEGS FOR MULTIPLE UP ASSEMBLIES.
- 2.) ADD 5.55 FROM CENTERLINE TO CENTERLINE OF PEG FOR INDIVIDUAL POWER MODULES STACKED NEXT TO EACH OTHER.

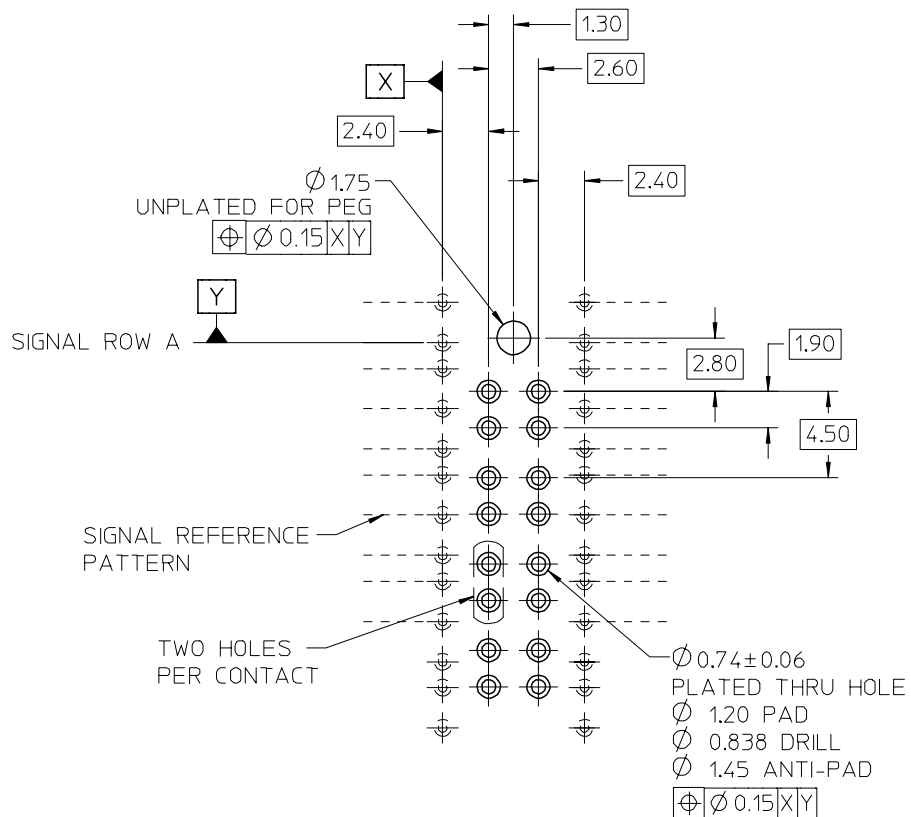

ADDED $\phi 0.74 \pm 0.06$ EC NO: UCF2008-0426 DRWN: C STEWART 2007/08/29 CHKD: J BINGHAM 2007/08/30 APPR: J BINGHAM 2007/08/31	QUALITY SYMBOLS	GENERAL TOLERANCES (UNLESS SPECIFIED)	DIMENSION STYLE	SCALE	DESIGN UNITS	THIRD ANGLE PROJECTION															
	$\nabla = 0$ $\nabla = 0$	<table border="1"> <thead> <tr> <th></th> <th>mm</th> <th>INCH</th> </tr> </thead> <tbody> <tr> <td>4 PLACES</td> <td>± ---</td> <td>± ---</td> </tr> <tr> <td>3 PLACES</td> <td>± ---</td> <td>± ---</td> </tr> <tr> <td>2 PLACES</td> <td>± ---</td> <td>± ---</td> </tr> <tr> <td>1 PLACE</td> <td>± ---</td> <td>± ---</td> </tr> </tbody> </table>		mm	INCH	4 PLACES	± ---	± ---	3 PLACES	± ---	± ---	2 PLACES	± ---	± ---	1 PLACE	± ---	± ---	MM ONLY	4:1	METRIC	
		mm	INCH																		
	4 PLACES	± ---	± ---																		
3 PLACES	± ---	± ---																			
2 PLACES	± ---	± ---																			
1 PLACE	± ---	± ---																			
DESCRIPTION	DRAWN BY: ELO DATE: 2006/04/06 CHECKED BY: DATE: 2005/02/22 APPROVED BY: CUNNINGHAM DATE: 2005/02/23	TITLE	GBX 4 PAIR BACKPLANE POWER SALES ASSEMBLY																		
REV	MATERIAL NO. SEE PREVIOUS DOCUMENT NO. SD-75341-001	DRAFT WHERE APPLICABLE MUST REMAIN WITHIN DIMENSIONS	SIZE B THIS DRAWING CONTAINS INFORMATION THAT IS PROPRIETARY TO MOLEX INCORPORATED AND SHOULD NOT BE USED WITHOUT WRITTEN PERMISSION	MOLEX MOLEX INCORPORATED	SHEET NO.	4 OF 4															

9 8 7 6 5 4 3 2 1