

**PLEASE CHECK WWW.MOLEX.COM FOR LATEST PART INFORMATION**

**Part Number:** [0307001061](#)  
**Status:** **Active**  
**Overview:** hdac 64 dualrow high density automotive connectors  
**Description:** 2.54mm (.100") Pitch, 0.64mm (.025") Width H-DAC 64™ High Density Automotive Connectors, Dual Row, Female Harness Assembly, 6 Circuits, Polarization Option 2, Black

**Documents:**

<a href="#">Drawing (PDF)</a>	<a href="#">Product Specification PS-30968-0001 (PDF)</a>
<a href="#">Application Specification (PDF)</a>	<a href="#">RoHS Certificate of Compliance (PDF)</a>
<a href="#">Product Specification PS-30700-0001 (PDF)</a>	

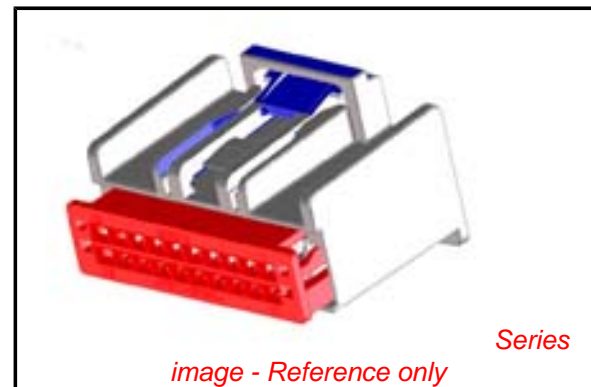

**General**

Product Family	Crimp Housings
Series	<a href="#">30700</a>
Comments	Polarization Option 2
Overview	<a href="#">hdac 64 dualrow high density automotive connectors</a>
Product Name	H-DAC 64™

**Physical**

Circuits (maximum)	6
Color - Resin	Black
Gender	Female
Glow-Wire Compliant	No
Lock to Mating Part	Yes
Material - Resin	Modified Polystyrene
Number of Rows	2
Packaging Type	Bag
Panel Mount	No
Pitch - Mating Interface (in)	0.100 In
Pitch - Mating Interface (mm)	2.54 mm
Polarized to Mating Part	Yes
Stackable	No
Temperature Range - Operating	-40°C to +105°C

**Electrical**

Current - Maximum per Contact	7A
-------------------------------	----

**Material Info**

**Reference - Drawing Numbers**

Packaging Specification	PK-30907-417
Product Specification	PS-30700-0001, PS-30968-0001
Sales Drawing	SD-30700-120

**EU RoHS**

**ELV and RoHS Compliant**  
**REACH SVHC Contains SVHC: No**  
**Halogen-Free Status**

**China RoHS**



**Not Reviewed**

**Need more information on product environmental compliance?**

Email [productcompliance@molex.com](mailto:productcompliance@molex.com)  
 For a multiple part number RoHS Certificate of Compliance, [click here](#)

Please visit the [Contact Us](#) section for any non-product compliance questions.

**Search Parts in this Series**

[30700Series](#)

**Mates With**

[30700 Header](#), [30968 Crimp Housing](#)

**Use With**

[34230 Terminal](#)

**CONNECTORS WITHOUT BRIDGE OPTION**

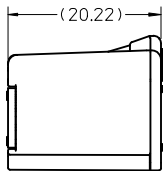
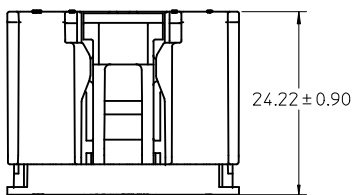

TPS SHOWN IN FULLY SEATED POSITION

SCOOP PROOF RIBS FOR CIRCUIT SIZES 14 THROUGH 20 ONLY

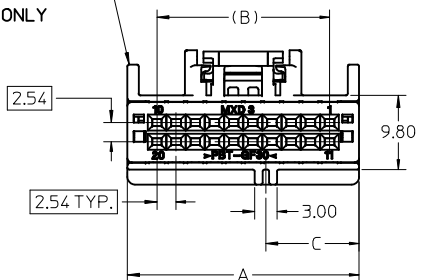

20 CIRCUIT HARNESS ASSEMBLY SHOWN

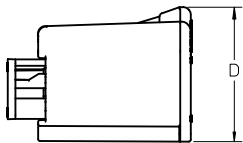

WITH TPA IN PRE-LOAD (AS SHIPPED)

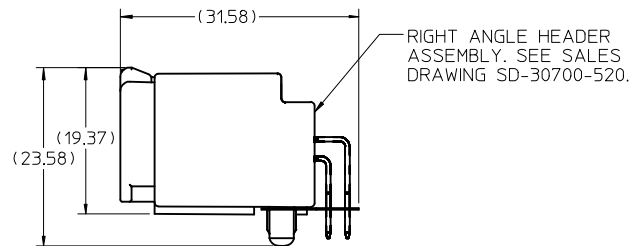
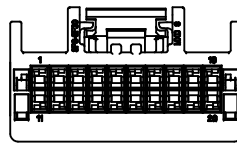

MATED VIEW

RIGHT ANGLE HEADER ASSEMBLY. SEE SALES DRAWING SD-30700-520.

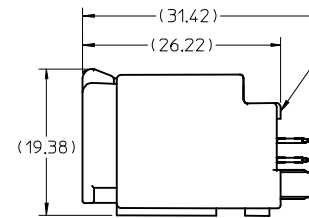

MATED VIEW

VERTICAL HEADER ASSEMBLY. SEE SALES DRAWING SD-30700-420.

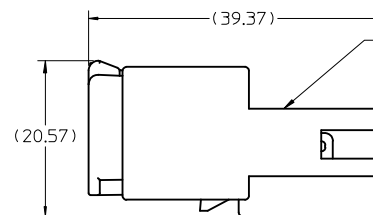

MATED VIEW

MALE INLINE HARNESS ASSEMBLY. SEE SALES DRAWING SD-30968-120.

**CONNECTORS WITH BRIDGE OPTION**

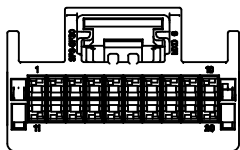

20 CIRCUIT HARNESS ASSEMBLY SHOWN

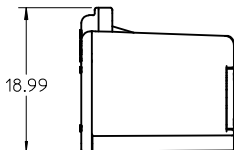

NOTES:

1. MATERIAL: HOUSING: SPS, GLASS FILLED, COLOR: SEE CHART. TPA: PBT, GLASS FILLED, COLOR: RED.
2. PRODUCT SPECIFICATION: PS-30700-0001
3. PACKAGING SPECIFICATION: PK-30907-417
4. MATES WITH: SERIES 30700 & 30968, SEE SALES DRAWINGS SD-30700-520, SD-30700-420 & SD-30968-120.

EC NO: UAU2008-0514 DRWN:BDICK01 2008/09/24 CHKD:MBAILLEY 2008/09/24 APPR:SMARCEA2008/09/25	QUALITY SYMBOLS ▽ - 0 ∇ - 0	GENERAL TOLERANCES (UNLESS SPECIFIED)		SCALE 2:1	DESIGN UNITS METRIC	THIRD ANGLE PROJECTION	REVISE ON CAD ONLY	
		mm	INCH	DIMENSION STYLE MM ONLY		TITLE 6-20 CIRCUIT HARNESS ASSEMBLY		
		4 PLACES ± --- ± ---	3 PLACES ± --- ± ---	DRAWN BY RCARLSON	DATE 01/03/23	MOLEX INCORPORATED		
		2 PLACES ± 0.13 ± ---	1 PLACE ± 0.25 ± ---	CHECKED BY CKRISHNA	DATE 01/03/27			
ANGULAR ± 1/2°		DRAFT WHERE APPLICABLE		APPROVED BY LGIEIB	DATE 01/03/28	MATERIAL NO. SEE CHART	DOCUMENT NO. SD-30700-120	SHEET NO. 1 OF 3
MUST REMAIN WITHIN DIMENSIONS		THIS DRAWING CONTAINS INFORMATION THAT IS PROPRIETARY TO MOLEX INCORPORATED AND SHOULD NOT BE USED WITHOUT WRITTEN PERMISSION						

ASSEMBLY PART NUMBER		POLARIZATION OPTIONS & CIRCUIT SIZE		PRODUCT DIMENSIONS					PASS THRU HOLE DIA FOR HARNESS	MATING INTERFACE DIMENSIONS	
WITHOUT BRIDGE	WITH BRIDGE	HARNESS ASSEMBLY (POLARIZATION OPTIONS)	CIRCUIT SIZE	A REF.	(B)	C	D	HOUSING COLOR		E	F
30700-1207	31389-1207	POLARIZATION OPTION #1	20	30.69	22.86	12.35	17.79	GRAY	36.5	12.57	31.14
30700-1208	31389-1208	POLARIZATION OPTION #2	20	30.69	22.86	15.35	17.79	BLACK	36.5	15.57	31.14
30700-1209	31389-1209	POLARIZATION OPTION #3	20	30.69	22.86	18.35	17.79	NATURAL (CREAM)	36.5	18.57	31.14
30700-1187	31389-1187	POLARIZATION OPTION #1	18	28.15	20.32	11.08	17.79	GRAY	34.0	11.31	28.60
30700-1188	31389-1188	POLARIZATION OPTION #2	18	28.15	20.32	14.08	17.79	BLACK	34.0	14.31	28.60
30700-1189	31389-1189	POLARIZATION OPTION #3	18	28.15	20.32	17.08	17.79	NATURAL (CREAM)	34.0	17.31	28.60
30700-1167	31389-1167	POLARIZATION OPTION #1	16	25.61	17.78	9.81	17.79	GRAY	32.0	10.04	26.06
30700-1168	31389-1168	POLARIZATION OPTION #2	16	25.61	17.78	12.81	17.79	BLACK	32.0	13.04	26.06
30700-1169	31389-1169	POLARIZATION OPTION #3	16	25.61	17.78	15.81	17.79	NATURAL (CREAM)	32.0	16.04	26.06
30700-1147	31389-1147	POLARIZATION OPTION #1	14	23.07	15.24	8.54	17.79	GRAY	30.0	8.77	23.52
30700-1148	31389-1148	POLARIZATION OPTION #2	14	23.07	15.24	11.54	17.79	BLACK	30.0	11.77	23.52
30700-1149	31389-1149	POLARIZATION OPTION #3	14	23.07	15.24	14.54	17.79	NATURAL (CREAM)	30.0	14.77	23.52
30700-1120	31389-1120	POLARIZATION OPTION #1	12	20.53	12.70	7.25	17.98	GRAY	27.5	7.50	20.98
30700-1121	31389-1121	POLARIZATION OPTION #2	12	20.53	12.70	10.27	17.98	BLACK	27.5	10.50	20.98
30700-1122	31389-1122	POLARIZATION OPTION #3	12	20.53	12.70	13.27	17.98	NATURAL (CREAM)	27.5	13.50	20.98
30700-1100	31389-1100	POLARIZATION OPTION #1	10	17.99	10.16	6.00	17.98	GRAY	26.4	6.23	18.44
30700-1101	31389-1101	POLARIZATION OPTION #2	10	17.99	10.16	9.00	17.98	BLACK	26.4	9.23	18.44
30700-1102	31389-1102	POLARIZATION OPTION #3	10	17.99	10.16	12.00	17.98	NATURAL (CREAM)	26.4	12.23	18.44
30700-1080	31389-1080	POLARIZATION OPTION #1	8	15.45	7.62	4.73	17.98	GRAY	25.5	4.96	15.90
30700-1081	31389-1081	POLARIZATION OPTION #2	8	15.45	7.62	7.73	17.98	BLACK	25.5	7.96	15.90
30700-1082	31389-1082	POLARIZATION OPTION #3	8	15.45	7.62	10.73	17.98	NATURAL (CREAM)	25.5	10.96	15.90
30700-1060	31389-1060	POLARIZATION OPTION #1	6	15.44	5.08	3.46	17.98	GRAY	25.5	3.69	13.36
30700-1061	31389-1061	POLARIZATION OPTION #2	6	15.44	5.08	6.46	17.98	BLACK	25.5	6.69	13.36
30700-1062	31389-1062	POLARIZATION OPTION #3	6	15.44	5.08	9.46	17.98	NATURAL (CREAM)	25.5	9.69	13.36

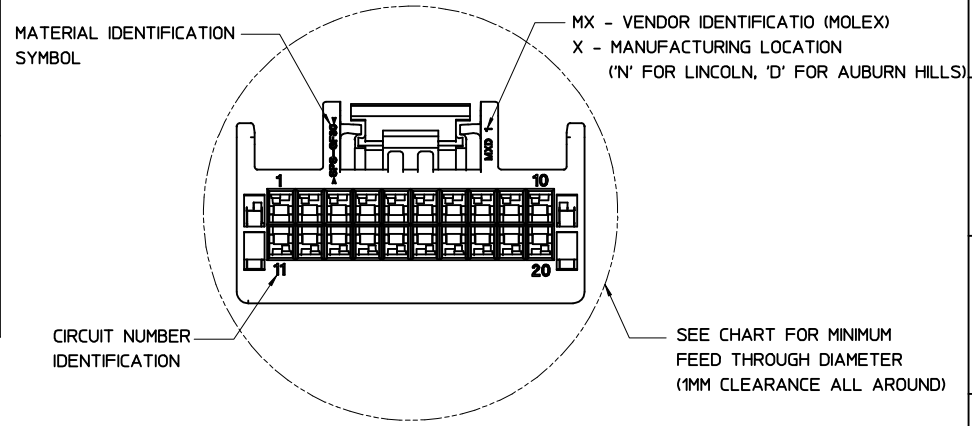
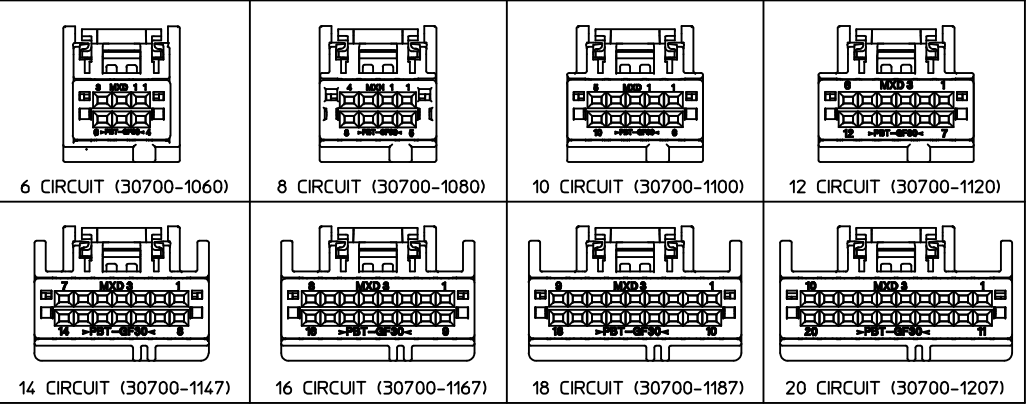
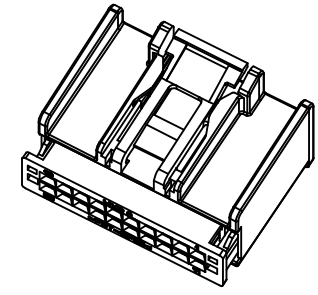

EC NO: UAU2008-0514 DRWN:BDICK01 2008/09/24 CHKD:MBAILLEY 2008/09/24 APPR:SMARCEA 2008/09/25	QUALITY SYMBOLS ▽ - 0 ▽ - 0	GENERAL TOLERANCES (UNLESS SPECIFIED)		SCALE 2:1	DESIGN UNITS METRIC	THIRD ANGLE PROJECTION	REVISE ON CAD ONLY	
		mm	INCH	DIMENSION STYLE MM ONLY		TITLE		
		4 PLACES ± ---	± ---	DRAWN BY RCARLSON	DATE 01/03/23	6-20 CIRCUIT HARNESS ASSEMBLY MOLEX INCORPORATED		
		3 PLACES ± ---	± ---	CHECKED BY CKRISHNA	DATE 01/03/27			
2 PLACES ± 0.13	± ---	DRAFT WHERE APPLICABLE		APPROVED BY LGIEIB	DATE 01/03/28	MATERIAL NO. SEE CHART	DOCUMENT NO. SD-30700-120	
1 PLACE ± 0.25	± ---	MUST REMAIN WITHIN DIMENSIONS		SHEET NO. 2 OF 3				
THIS DRAWING CONTAINS INFORMATION THAT IS PROPRIETARY TO MOLEX INCORPORATED AND SHOULD NOT BE USED WITHOUT WRITTEN PERMISSION								

# MATING INTERFACE DIMENSIONS (REFERENCE ONLY)

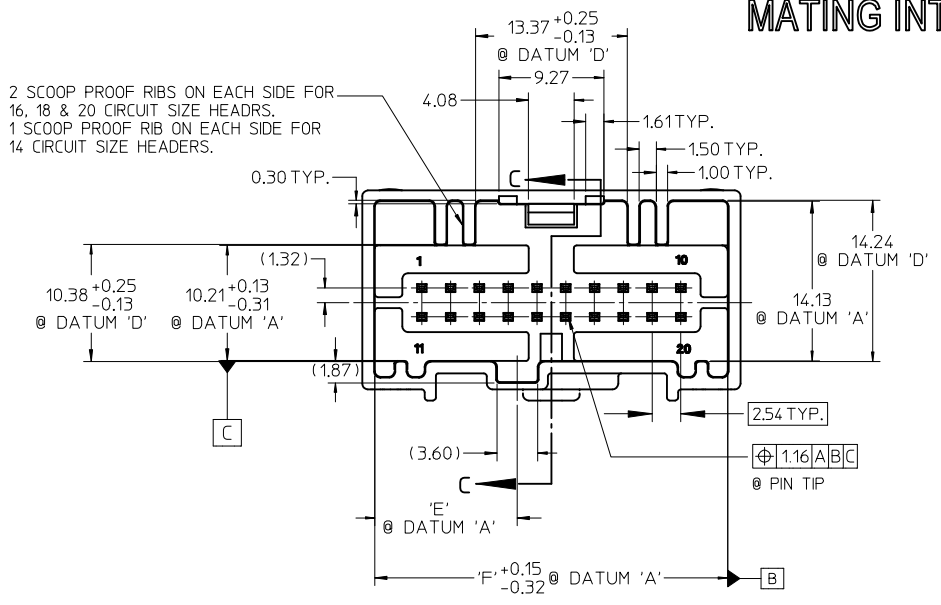

ABOVE VIEW APPLY TO 14, 16, 18 & 20 CIRCUIT ONLY

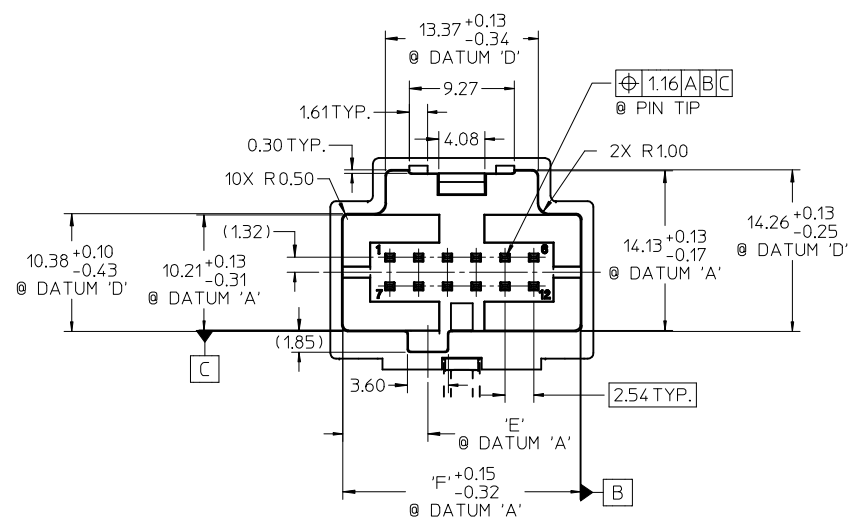

ABOVE VIEW APPLY TO 6, 8, 10 & 12 CIRCUIT ONLY

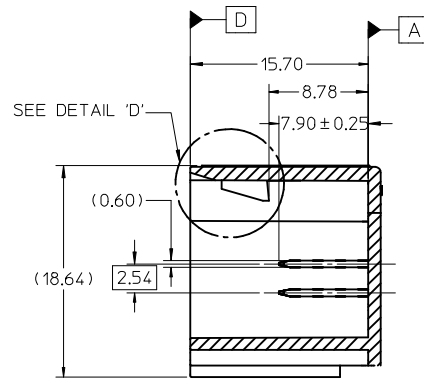
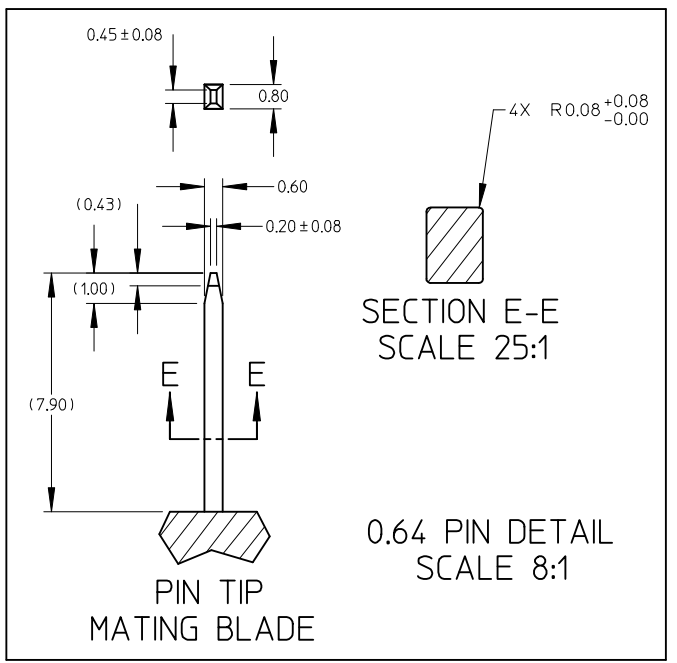

SECTION C-C

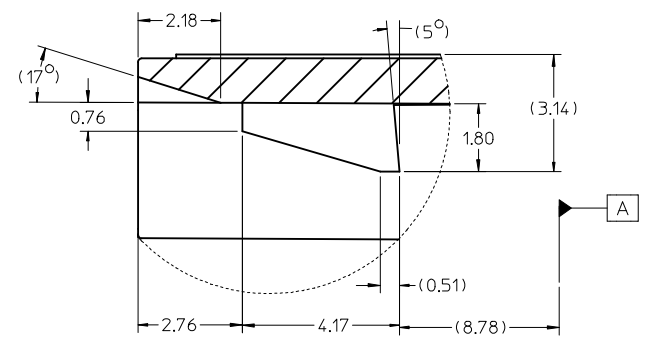

DETAIL 'D' SCALE 10:1

EC NO: UAU2008-0514 DRW: BDICK01 2008/09/24 CHK: SWARCE#008/09/24 APPR: MKNACK 2008/09/25	QUALITY SYMBOLS	GENERAL TOLERANCES (UNLESS SPECIFIED)		SCALE 1:1	DESIGN UNITS METRIC	THIRD ANGLE PROJECTION	REVISE ON CAD ONLY	
	REV DESCRIPTION 0 0		mm	INCH	DIMENSION STYLE		6-20 CIRCUIT HARNESS ASSEMBLY	
		4 PLACES ± --- ± ---			MM ONLY			
		3 PLACES ± --- ± ---			DRAWN BY	DATE		
	2 PLACES ± 0.13 ± ---			RCARLSON01/03/23				
	1 PLACE ± 0.25 ± ---			CHECKED BY	DATE			
	ANGULAR ± 1/2 °			CKRISHNA	01/03/27			
	DRAFT WHERE APPLICABLE MUST REMAIN WITHIN DIMENSIONS			APPROVED BY	DATE	MATERIAL NO.	DOCUMENT NO.	
				LGEIB	01/03/28		SD-30700-120	
				THIS DRAWING CONTAINS INFORMATION THAT IS PROPRIETARY TO MOLEX INCORPORATED AND SHOULD NOT BE USED WITHOUT WRITTEN PERMISSION			SHEET NO. 3 OF 3	