

PLEASE CHECK WWW.MOLEX.COM FOR LATEST PART INFORMATION

Part Number: [5013290222](#)
Status: **Active**
Overview: [inertia lock 330mm wiretowire system](#)
Description: 3.30mm (.130") Pitch Wire-to-Wire Inertia Lock Plug Housing, Single Row, 2 Circuits, Red

Documents:

[Drawing \(PDF\)](#) [RoHS Certificate of Compliance \(PDF\)](#)
[Product Specification PS-501328-001 \(PDF\)](#)

General

Product Family Crimp Housings
 Series [501329](#)
 Overview [inertia lock 330mm wiretowire system](#)
 Product Name Inertia Lock

Physical

Circuits (maximum) 2
 Color - Resin Red
 Gender Male
 Glow-Wire Compliant No
 Lock to Mating Part Yes
 Material - Resin Nylon
 Number of Rows 1
 Packaging Type Bag
 Panel Mount No
 Pitch - Mating Interface (in) 0.130 In
 Pitch - Mating Interface (mm) 3.30 mm
 Polarized to Mating Part Yes
 Stackable No
 Temperature Range - Operating -25°C to +80°C

Electrical

Current - Maximum per Contact 4A

Material Info

Reference - Drawing Numbers

Packaging Specification SPK-501329-001
 Product Specification PS-501328-001, RPS-501328-001, RPS-501328-002, RPS-501328-003
 Sales Drawing SD-501329-001

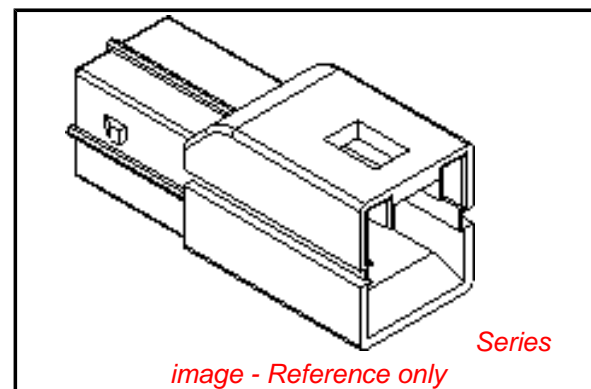

EU RoHS

ELV and RoHS Compliant
REACH SVHC
 Not Reviewed
Halogen-Free Status
 Not Reviewed

China RoHS



Need more information on product environmental compliance?

Email productcompliance@molex.com
 For a multiple part number RoHS Certificate of Compliance, [click here](#)

Please visit the [Contact Us](#) section for any non-product compliance questions.

Search Parts in this Series

[501329Series](#)

Mates With

[501328-0222](#) Receptacle Housing . [501395](#) Receptacle Terminal for AWG#18-20 . [500989](#) Receptacle Terminal for AWG#22-26

Use With

[51348-0213](#) Retainer . [56265](#) Plug Terminal for AWG#18- 20 . [56279](#) Plug Terminal for AWG#22-26

10 9 8 7 6 5 4 3 2 1

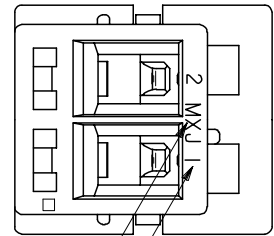

トレードマーク
TRADE MARK.

回路番号
CKT No.

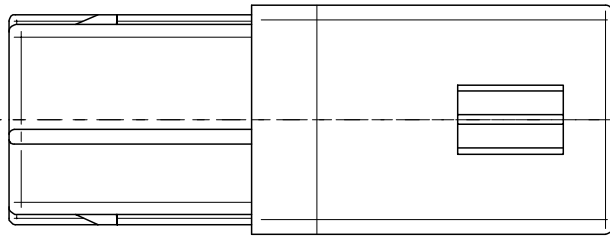

24.5

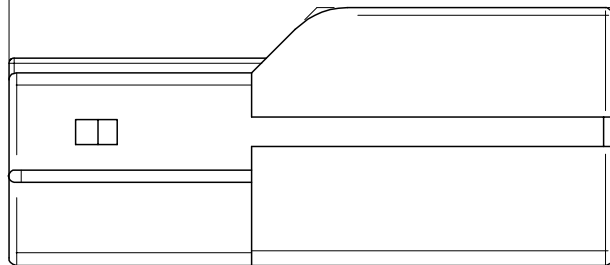

10.45

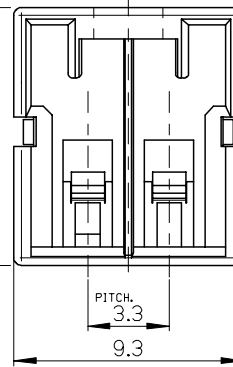

PITCH
3.3
9.3

注記
NOTES.

- △ 適合リテーナ : 51348-0213
APPLICABLE RETAINER
詳細は SD-51348-001 を参照下さい。
REFERENCE:SD-51348-001
- 2. 材料 : NYLON66,UL94V-0
MATERIAL

本形状は 501329-0200 を示す。
SHAPE OF 501329-0200

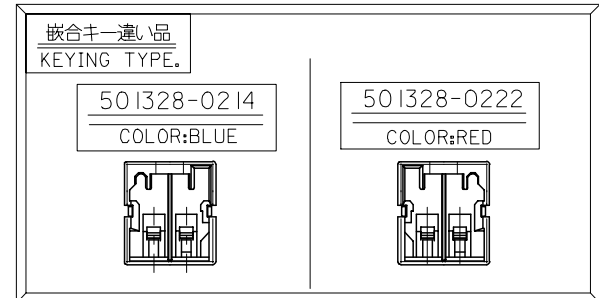
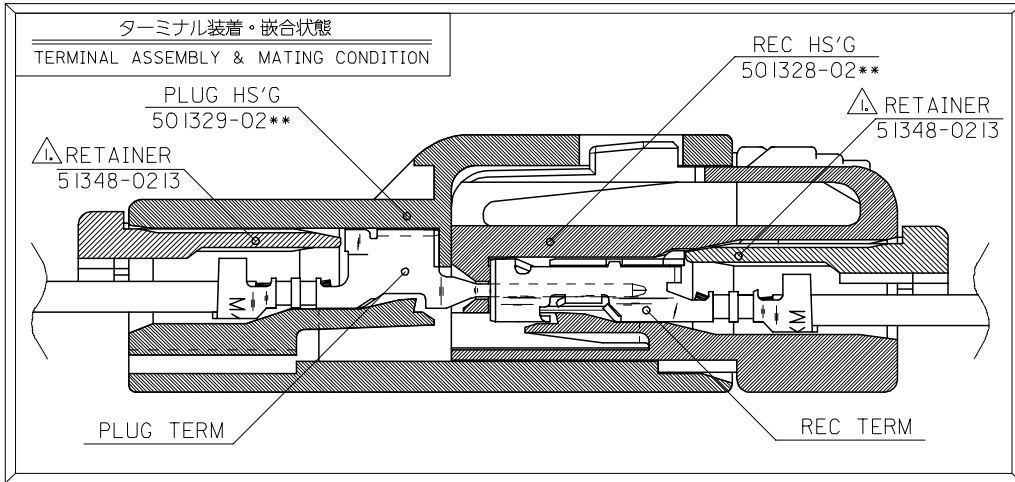

BLUE	501329-0214	501329-02**
RED	501329-0222	
WHITE	501329-0200	
COLOR	MATERIAL No.	MODEL No.

RELEASED EC NO: J2005-2177 DRWN:TODA 2005/03/31 CHKDK:ASAKAWA 2005/03/31 APPR:S.ICHIKAWA 2005/03/31	GENERAL TOLERANCES (UNLESS SPECIFIED)		DIMENSION STYLE MM ONLY		SCALE 5:1	DESIGN UNITS METRIC	THIRD ANGLE PROJECTION	
	10 UNDER	±0.2	DRAWN BY T.ODA	DATE '04/09/30	TITLE 3.3 W/W INERTIA LOCK CONN PLUG 2CKT			
	10 OVER 30 UNDER	±0.25	CHECKED BY K.ASAKAWA	DATE '04/09/30	APPROVED BY S.ICHIKAWA			
	30 OVER	±0.3	DATE '04/09/30	MATERIAL NO. SEE CHART				
	ANGULAR	±3 °	DRAFT WHERE APPLICABLE MUST REMAIN WITHIN DIMENSIONS		DOCUMENT NO. SD-501329-001		SHEET NO. 1 OF 1	