

ChargePump™ High Efficiency 1.5X Fractional Charge Pump For White LED Applications

General Description

The AAT3194 is a low noise, constant frequency charge pump DC/DC converters that use fractional (1.5X) conversion to increase efficiency in white LED applications. The devices can be used to produce current levels up to 20mA for each output from a 2.7V to 5.5V input. A low external parts count (two 1µF flying capacitors and two small bypass capacitors at IN and OUT) makes these devices ideally suited for small, battery-powered applications.

AnalogicTech's Simple Serial Control™ (S²Cwire™) interface is used to enable, disable, and set the LED drive current for 32-level logarithmic scale LED brightness control. The AAT3194 has a thermal management system for protection in the event of a short-circuit condition on any of the output pins. Built-in soft-start circuitry prevents excessive inrush current during start-up. A high switching frequency enables the use of small external capacitors. A low-current shutdown feature disconnects the load from V_{IN} and reduces quiescent current to less than 1µA. The AAT3194 is available in a Pb-free 12-pin TSOPJW package.

Features

- V_{IN} Range: 2.7V to 5.5V
- 20mA Full-Scale Current
- Simple Serial Control (S²Cwire) Interface
 - 32-Position Logarithmic Scale with Digital Control
- Low Noise Constant Frequency Operation
- 33% Less Input Current Than Doubler Charge Pump
- High Accuracy Brightness Matching
- Small Application Circuit
- Regulated Output Current
- Automatic Soft Start
- No Inductors
- 600kHz Switching Frequency
- I_Q < 1µA in Shutdown
- Temperature Range: -40°C to 85°C
- 12-Pin TSOPJW Package

Applications

- Programmable Current Source
- White LED Backlighting

Typical Application

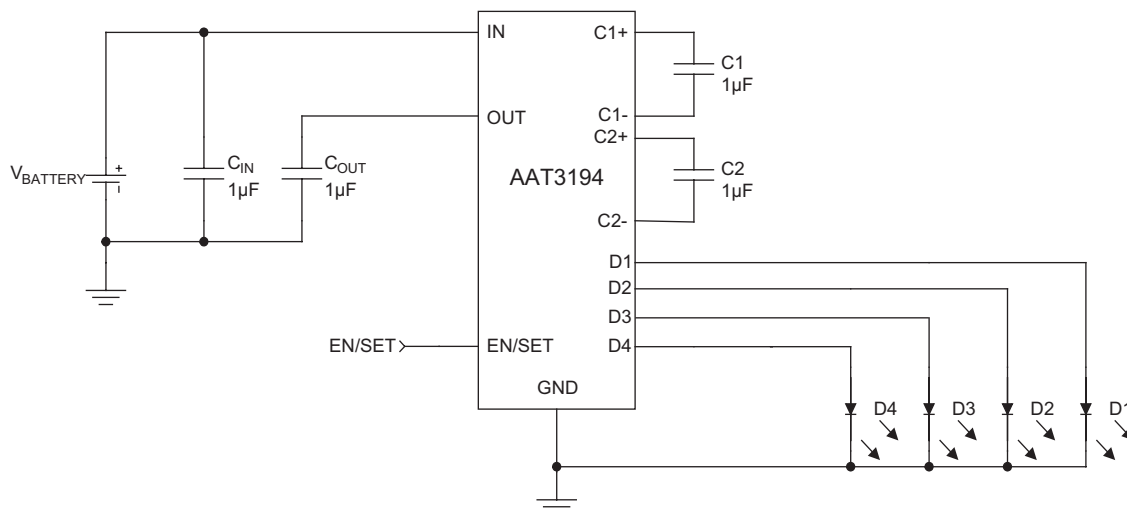

ChargePump™ High Efficiency 1.5X Fractional Charge Pump For White LED Applications

Pin Descriptions

Pin #	Symbol	Function
1	C2+	Flying capacitor 2 positive terminal. Connect a 1μF ceramic capacitor between C2+ and C2-.
2	OUT	Charge pump output. Requires 1μF bypass capacitor to ground.
3	C1-	Flying capacitor 1 negative terminal.
4	C1+	Flying capacitor 1 positive terminal. Connect a 1μF ceramic capacitor between C1+ and C1-.
5	D4	Current source output 4. If not used, leave pin floating.
6	D3	Current source output 3. If not used, leave pin floating.
7	D2	Current source output 2. If not used, leave pin floating.
8	D1	Current source output 1. Required reference current source. Do not leave pin floating.
9	EN/SET	Control pin using S ² Cwire serial interface.
10	IN	Input power supply. Requires 1μF or larger ceramic capacitor to ground.
11	GND	Ground.
12	C2-	Flying capacitor 2 negative terminal.

Pin Configuration

TSOPJW-12
(Top View)

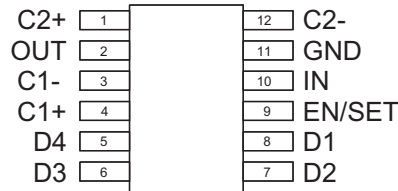

ChargePump™ High Efficiency 1.5X Fractional Charge Pump For White LED Applications**Absolute Maximum Ratings**

$T_A = 25^\circ\text{C}$, unless otherwise noted.

Symbol	Description	Value	Units
V_{IN}	Input Voltage	-0.3 to 6	V
V_{OUT}	Charge Pump Output	-0.3 to 6	V
$V_{EN/SET}$	EN/SET to GND Voltage	-0.3 to 6	V
$V_{EN/SET(MAX)}$	Maximum EN/SET to Input Voltage	0.3	V
I_{OUT}	Maximum DC Output Current (sum of I_{OUT} and D currents)	120	mA
T_J	Operating Junction Temperature Range	-40 to 150	$^\circ\text{C}$

Thermal Information¹

Symbol	Description	Value	Units
θ_{JA}	Thermal Resistance	160	$^\circ\text{C}/\text{W}$
P_D	Maximum Power Dissipation ²	625	mW

1. Mounted on an FR4 board.
2. Derate 6.25mW/ $^\circ\text{C}$ above 25 $^\circ\text{C}$.

ChargePump™ High Efficiency 1.5X Fractional Charge Pump For White LED Applications
Electrical Characteristics
 $V_{IN} = 3.5V$, $T_A = -40^{\circ}C$ to $+85^{\circ}C$, unless otherwise noted. Typical values are at $T_A = 25^{\circ}C$.

Symbol	Description	Conditions	Min	Typ	Max	Units
Input Power Supply						
V_{IN}	Operation Range		2.7			V
I_{CC}	Operating Current	Active, No Load Current			3	mA
I_{SHDN}	Shutdown Current	EN = 0V			1	μA
I_{DX}	Output Current	$3.0V \leq V_{IN} \leq 5.5V$, $T_A = 25^{\circ}C$, All Outputs Max Current	16	20	24	mA
$\Delta I_D / \Delta V_{IN}$	Output Current Line Regulation	$3.0V \leq V_{IN} \leq 5.5V$	-3		3	%/V
$I_{(D-Match)}$	Current Matching Between Any Two Outputs	VD1:Dn = 3.6V, $V_{IN} = 3.3V$		0.3		%
η	Efficiency	$V_{IN} = 3.5V$, $I_{OUT(total)} = 40mA$		93		%
Charge Pump						
t_{SS}	Soft-Start Time			400		μs
F_{CLK}	Clock Frequency		300			kHz
EN/SET						
$V_{EN(L)}$	Enable Threshold Low	$V_{IN} = 2.7V$ to $5.5V$			0.5	V
$V_{EN(H)}$	Enable Threshold High	$V_{IN} = 2.7V$ to $5.5V$	1.4			V
t_{LO}	EN/SET Low Time		0.3		75	μs
t_{HI}	Minimum EN/SET Regulation			50		ns
t_{OFF}	EN/SET Off Timeout				500	μs
Input Current	EN/SET Input Leakage	$V_{IN} = 5.5V$	-1		1	μA

ChargePump™ High Efficiency 1.5X Fractional Charge Pump For White LED Applications

Typical Characteristics

$V_{IN} = 3.5V$, $C_{IN} = C_{OUT} = C_1 = C_2 = 1\mu F$; $T_A = 25^\circ C$, unless otherwise noted.

Quiescent Current vs. Temperature

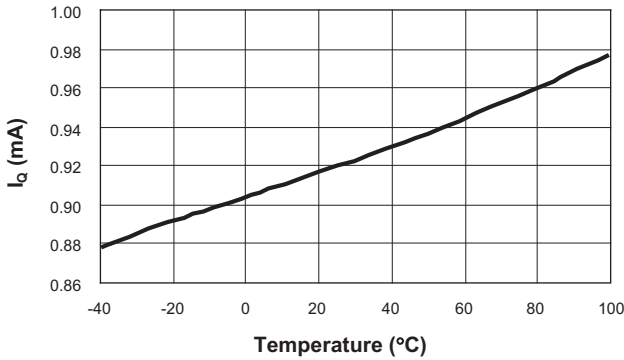

Efficiency vs. Supply Voltage

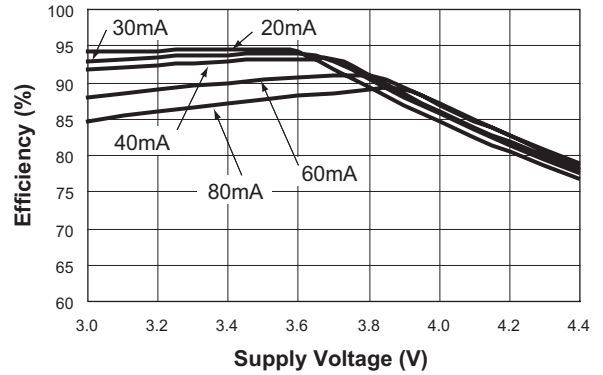

Quiescent Current vs. Supply Voltage

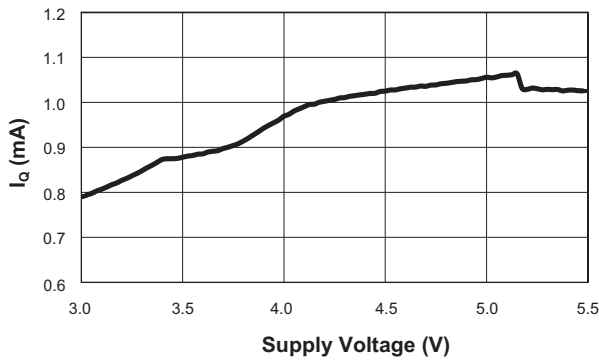

Efficiency vs. Load Current

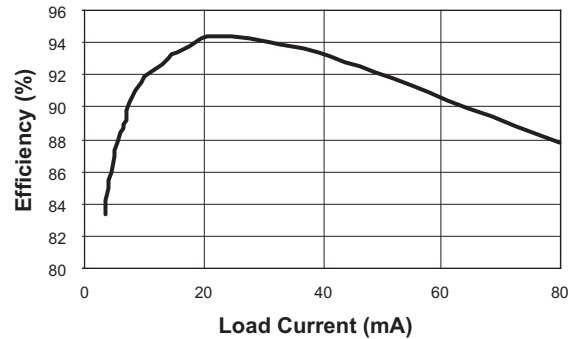

Shutdown Current vs. Temperature

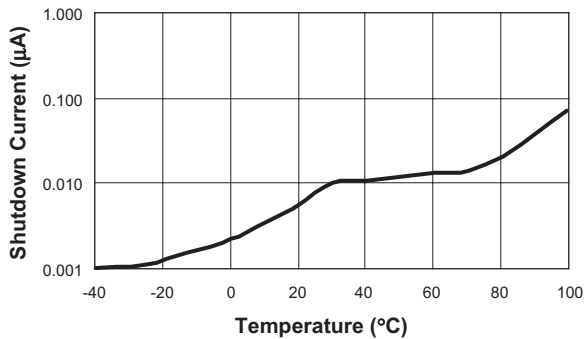

Oscillator Frequency vs. Temperature

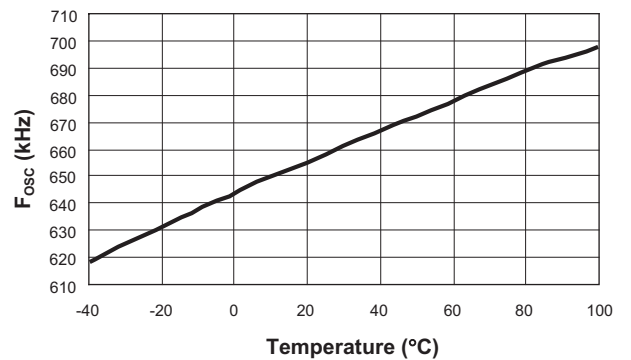

ChargePump™ High Efficiency 1.5X Fractional Charge Pump For White LED Applications

Typical Characteristics

$V_{IN} = 3.5V$, $C_{IN} = C_{OUT} = C_1 = C_2 = 1\mu F$; $T_A = 25^\circ C$, unless otherwise noted.

Normalized I_{DIODE} vs. Temperature

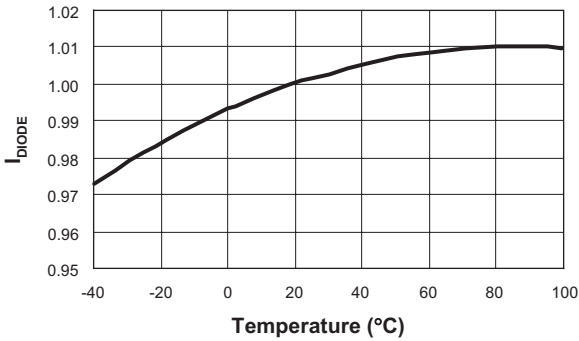

I_{DIODE} Response (-31dB to 0dB)

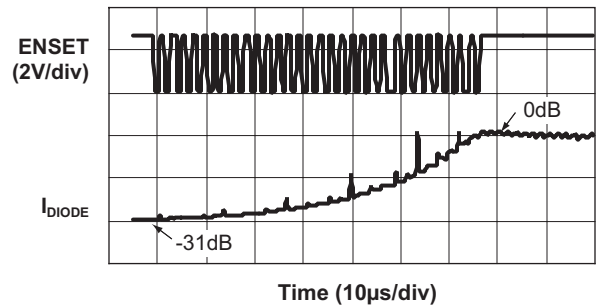

I_{DIODE} vs. V_{IN}

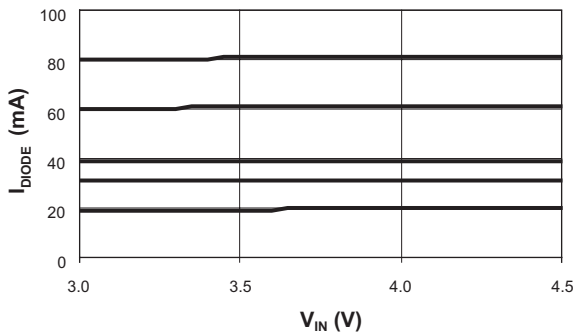

I_{DIODE} Response (-9dB to -10dB)

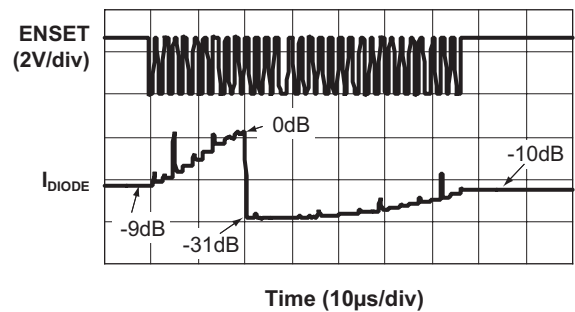

I_{DIODE} vs. V_{DIODE}

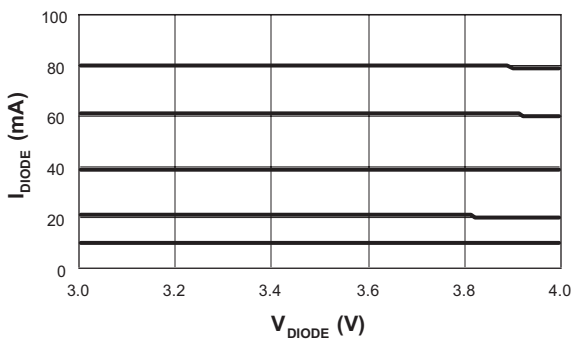

V_{IH} and V_{IL} vs. V_{IN}

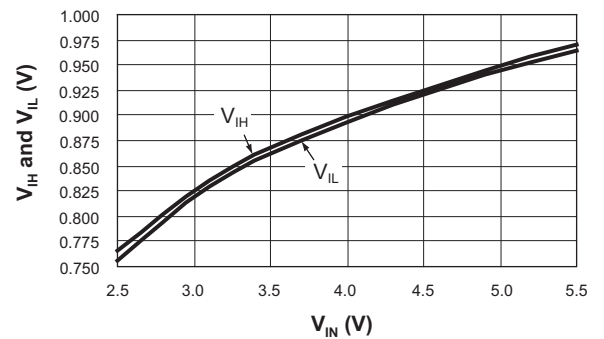

ChargePump™ High Efficiency 1.5X Fractional Charge Pump For White LED Applications

Typical Characteristics

$V_{IN} = 3.5V$, $C_{IN} = C_{OUT} = C_1 = C_2 = 1\mu F$; $T_A = 25^\circ C$, unless otherwise noted.

Turn-On

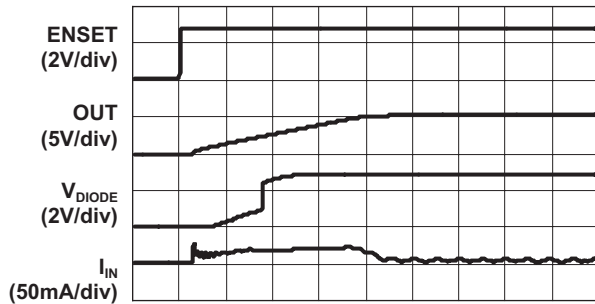

Time (100µs/div)

Turn-Off

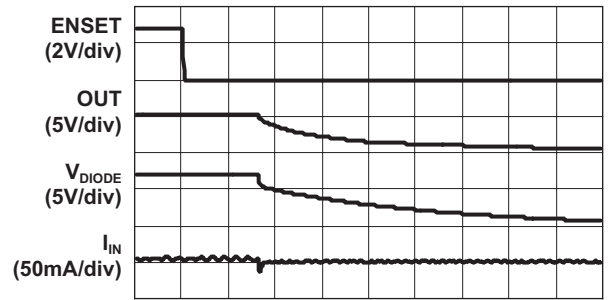

Time (200µs/div)

40mA Load Characteristics

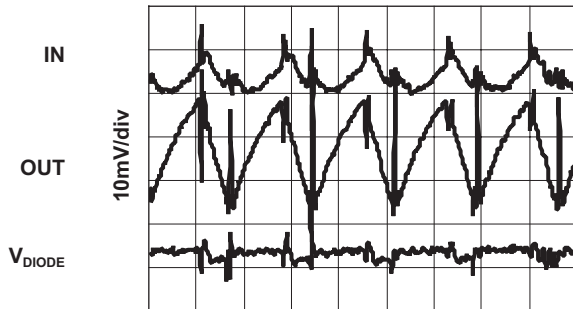

Time (1µs/div)

60mA Load Characteristics

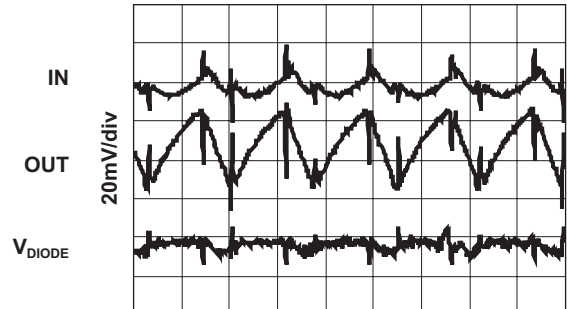

Time (1µs/div)

80mA Load Characteristics

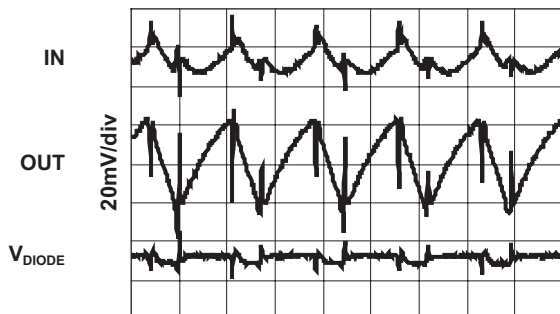

Time (1µs/div)

Functional Block Diagram

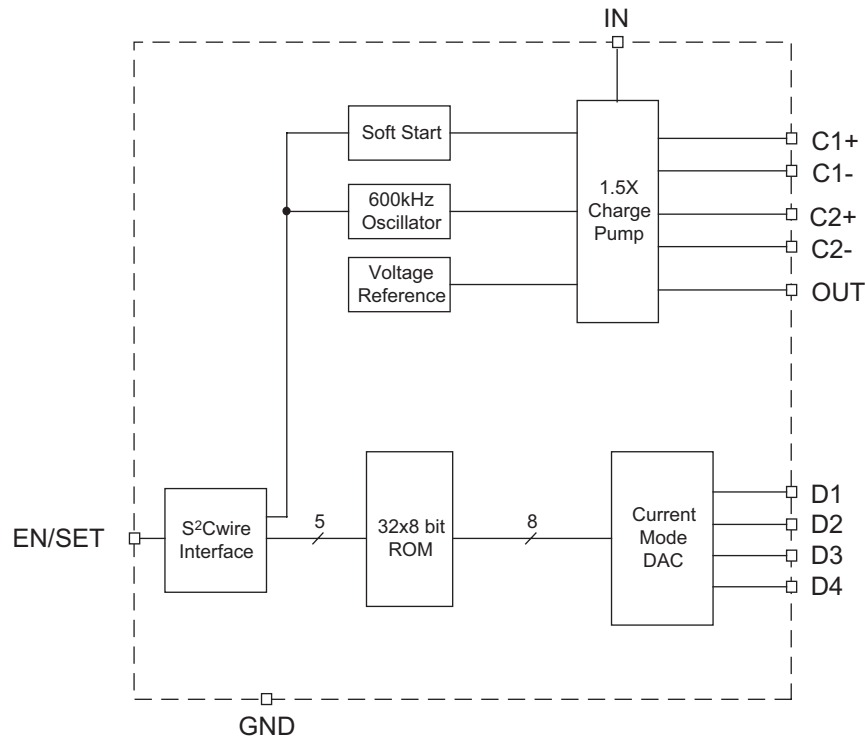

Functional Description

The AAT3194 is a high efficiency 1.5X fractional charge pumps intended for white LED backlight applications. The fractional charge pump consists of a linear regulator followed by a 1.5X charge pump. The AAT3194 requires only four external components: two 1µF ceramic capacitors for the charge pump flying capacitors (C1 and C2), one 1µF ceramic capacitor for C_{IN}, and one 0.33µF to 1µF ceramic capacitor for C_{OUT}. The charge pump output is converted into four constant current outputs (D1 to D4) to drive four individual LEDs with a maximum of 20mA each. The current source output magnitude is controlled by the EN/SET serial data S²Cwire interface. The interface records rising edges of the EN/SET pin and decodes them into 32 indi-

vidual current level settings each 1dB apart (see Table 1, Current Level Settings). Code 32 is full scale, and Code 1 is full scale attenuated by 31dB. The modulo 32 interface wraps states back to state 1 after the 32nd clock. With each EN/SET pulse, the output current increases by 1dB. To decrease the output current by 1dB, 31 EN/SET clock pulses are required. The counter can be clocked at speeds up to 1MHz, so intermediate states are not visible. The first rising edge of EN/SET enables the IC and initially sets the output LED current to -31dB, the lowest setting equal to 525µA. Once the final clock cycle is input for the desired brightness level, the EN/SET pin is held high to maintain the device output current at the programmed level. The device is disabled 500µs after the EN/SET pin transitions to a logic low state.

Applications Information

Current Level Settings

LED current level is set via the serial interface according to a logarithmic scale where each code is 1dB greater than the previous code. In this manner, the LED brightness appears linear with each increasing code.

Code	20mA max	Code	20mA max
1	0.549	17	3.529
2	0.627	18	4.000
3	0.706	19	4.471
4	0.784	20	5.020
5	0.863	21	5.647
6	1.020	22	6.353
7	1.098	23	7.059
8	1.255	24	7.922
9	1.412	25	8.941
10	1.569	26	10.039
11	1.804	27	11.216
12	1.961	28	12.627
13	2.275	29	14.118
14	2.510	30	15.843
15	2.824	31	17.804
16	3.137	32	20.000

Table 1: Current Level Settings.

EN/SET Serial Interface

The current source output magnitude is controlled by the EN/SET pin using AnalogicTech's Simple Serial Control (S²Cwire) interface. The interface records rising edges of the EN/SET pin and decodes them into 32 individual current level settings each 1dB apart. Code 32 is full scale, and Code 1 is full scale attenuated by 31dB. The modulo 32 interface wraps states back to state 1 after the 32nd clock, so 1dB of attenuation is achieved by clocking the EN/SET pin 31 times (see graph titled, "I_{DIODE} Response -9dB to -10dB"). The counter can be clocked at speeds up to 1MHz, so intermediate states are not visible. The first rising edge of EN/SET enables the IC and initially sets the output LED current to -31dB, the lowest setting equal to 525µA. Once the final clock cycle is input for the desired brightness level, the EN/SET pin is held high to maintain the device output current at the programmed level. The device is disabled 500µs after the EN/SET pin transitions to a logic low state.

The EN/SET timing is designed to accommodate a wide range of data rates. After the first rising edge of EN/SET, the charge pump is enabled and reaches full capacity after the soft-start time (T_{SS}). During the soft-start time, multiple clock pulses may be entered on the EN/SET pin to set the final output current level with a single burst of clocks. Alternatively, the EN/SET clock pulses may be entered one at a time to gradually increase the LED brightness over any desired time period. A constant current is sourced as long as EN/SET remains in a logic high state. The current source outputs are switched off after EN/SET has remained in a low state for at least the t_{OFF} timeout period (see Figure 2).

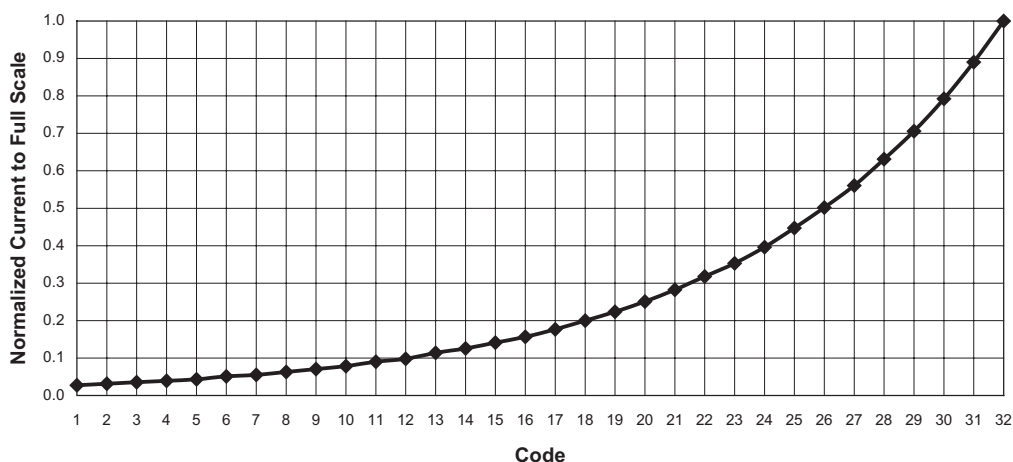

Figure 1: Normalized Current Level Settings.

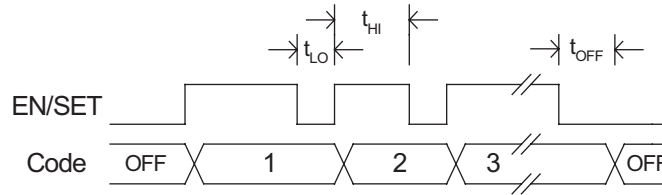

Figure 2: EN/SET Timing Diagram.

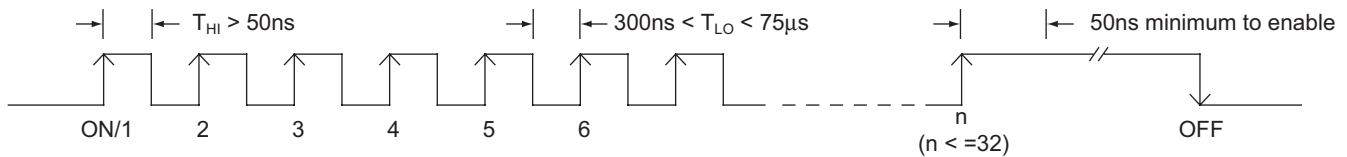

Figure 3: Enable / Disable / LED Brightness Level Set Data Input.

LED Selection

The AAT3194 is designed to drive white LEDs with forward voltages to 4.2V. Since the D1:D4 output current sources are matched with negligible voltage dependence, the LED brightness will be matched regardless of their forward voltage matching.

Charge Pump Efficiency

The AAT3194 uses a fractional charge pump. The efficiency (η) can be simply defined as a linear voltage regulator with an effective output voltage that is equal to one and one half times the input voltage. Efficiency (η) for an ideal 1.5X charge pump can typically be expressed as the output power divided by the input power:

$$\eta = \frac{P_{OUT}}{P_{IN}}$$

In addition, with an ideal 1.5X charge pump, the output current may be expressed as 2/3 of the input current. The expression to define the ideal efficiency (η) can be rewritten as:

$$\eta = \frac{P_{OUT}}{P_{IN}} = \frac{V_{OUT} \cdot I_{OUT}}{V_{IN} \cdot 1.5I_{OUT}} = \frac{V_{OUT}}{1.5V_{IN}}$$

-or-

$$\eta(\%) = 100 \left(\frac{V_{OUT}}{1.5V_{IN}} \right)$$

For a charge pump with an output of 5V and a nominal input of 3.5V, the theoretical efficiency is 95%. Due to

internal switching losses and IC quiescent current consumption, the actual efficiency can be measured at 93%. These figures are in close agreement for output load conditions from 1mA to 100mA. Efficiency will decrease as load current drops below 0.05mA or when the level of the power supply of IN approaches OUT. Refer to the Typical Characteristics section of this datasheet for measured plots of efficiency versus input voltage and output load current for the given charge pump output voltage options.

Power Efficiency and Device Evaluation

The charge pump efficiency discussion in the previous section only accounts for efficiency of the charge pump section itself. Due to the unique circuit architecture and design of the AAT3194, it is very difficult to measure efficiency in terms of a percent value comparing input power over output power. Since the device outputs are pure constant current sources, it is difficult to measure the output voltage for a given output (D1 to D4) to derive an output power measurement. For any given application, white LED forward voltage levels can differ, yet the output drive current will be maintained as a constant. This makes quantifying output power a difficult task when taken in the context of comparing to other white LED driver circuit topologies. A better way to quantify total device efficiency is to observe the total input power to the device for a given LED current drive level. The best white LED driver for a given application should be based on trade-offs of size, external components count, reliability, operating range, and total energy usage...not just "% efficiency."

ChargePump™ High Efficiency 1.5X Fractional Charge Pump For White LED Applications

Figure 3: Input Power vs. LED Current.

Capacitor Selection

Careful selection of the four external capacitors C_{IN} , C_1 , C_2 , and C_{OUT} is important because they will affect turn-on time, output ripple, and transient performance. Optimum performance will be obtained when low equivalent series resistance (ESR) ceramic capacitors are used. In general, low ESR may be defined as less than 100m Ω . A value of 1 μ F for all four capacitors is a good starting point when choosing capacitors. If the LED current sources are only programmed for minimal current levels, then the capacitor size may be decreased.

Capacitor Characteristics

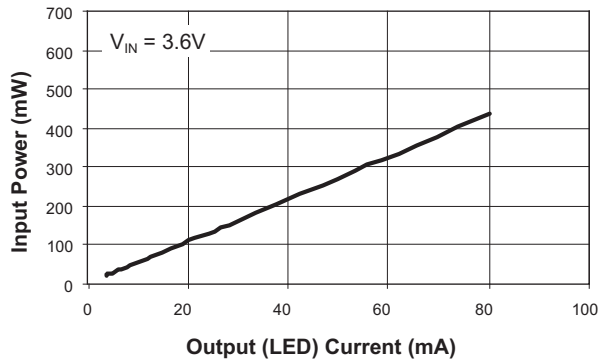
Ceramic composition capacitors are highly recommended over all other types of capacitors for use with the AAT3194. Ceramic capacitors offer many advantages over their tantalum and aluminum electrolytic counterparts. A ceramic capacitor typically has very low ESR, is lowest cost, has a smaller PCB footprint, and is non-polarized. Low ESR ceramic capacitors help maximize charge pump transient response. Since ceramic capacitors are non-polarized, they are not prone to incorrect connection damage.

Equivalent Series Resistance

ESR is an important characteristic to consider when selecting a capacitor. ESR is a resistance internal to a capacitor that is caused by the leads, internal connections, size or area, material composition, and ambient temperature. Capacitor ESR is typically measured in milliohms for ceramic capacitors and can range to more than several ohms for tantalum or aluminum electrolytic capacitors.

Ceramic Capacitor Materials

Ceramic capacitors less than 0.1 μ F are typically made from NPO or C0G materials. NPO and C0G materials generally have tight tolerance and are very stable over temperature. Larger capacitor values are usually composed of X7R, X5R, Z5U, or Y5V dielectric materials. Large ceramic capacitors (i.e., greater than 2.2 μ F) are often available in low-cost Y5V and Z5U dielectrics, but capacitors greater than 1 μ F are not typically required for AAT3194 applications.

Capacitor area is another contributor to ESR. Capacitors that are physically large will have a lower ESR when compared to an equivalent material smaller capacitor. These larger devices can improve circuit transient response when compared to an equal value capacitor in a smaller package size.

Test Current/Channel Disable

Each channel of the output is equipped with a test current function. The AAT3194 uses a small (\sim 2 μ A) current source injected into each output pin to detect the presence of an LED. Unused channels other than channel 1 should be left open and will be automatically disabled instead of wasting the programmed output current.

Thermal Protection

The AAT3194 has a thermal protection circuit that will shut down the charge pump and current outputs if the die temperature rises above the thermal limit.

ChargePump™ High Efficiency 1.5X Fractional Charge Pump For White LED Applications

Ordering Information

Package	Marking ¹	Part Number (Tape and Reel) ²
TSOPJW-12	UUXYY	AAT3194I TP-20-T1



All AnalogicTech products are offered in Pb-free packaging. The term “Pb-free” means semiconductor products that are in compliance with current RoHS standards, including the requirement that lead not exceed 0.1% by weight in homogeneous materials. For more information, please visit our website at <http://www.analogictech.com/about/quality.aspx>.

Package Information

TSOPJW-12

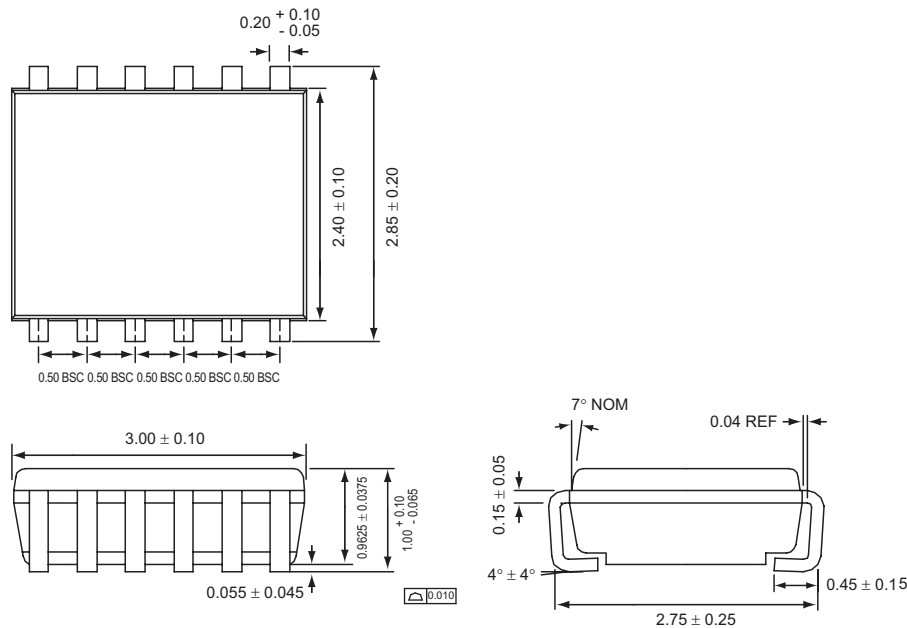

All dimensions in millimeters.

1. XYY = assembly and date code.
2. Sample stock is generally held on part numbers listed in **BOLD**.

Advanced Analogic Technologies, Inc.
 3230 Scott Boulevard, Santa Clara, CA 95054
 Phone (408) 737-4600
 Fax (408) 737-4611



© Advanced Analogic Technologies, Inc. AnalogicTech cannot assume responsibility for use of any circuitry other than circuitry entirely embodied in an AnalogicTech product. No circuit patent licenses, copyrights, mask work rights, or other intellectual property rights are implied. AnalogicTech reserves the right to make changes to their products or specifications or to discontinue any product or service without notice. Except as provided in AnalogicTech's terms and conditions of sale, AnalogicTech assumes no liability whatsoever, and AnalogicTech disclaims any express or implied warranty relating to the sale and/or use of AnalogicTech products including liability or warranties relating to fitness for a particular purpose, merchantability, or infringement of any patent, copyright or other intellectual property right. In order to minimize risks associated with the customer's applications, adequate design and operating safeguards must be provided by the customer to minimize inherent or procedural hazards. Testing and other quality control techniques are utilized to the extent AnalogicTech deems necessary to support this warranty. Specific testing of all parameters of each device is not necessarily performed. AnalogicTech and the AnalogicTech logo are trademarks of Advanced Analogic Technologies Incorporated. All other brand and product names appearing in this document are registered trademarks or trademarks of their respective holders.