

BLF6G22-180PN

Power LDMOS transistor

Rev. 02 — 23 April 2008

Product data sheet

1. Product profile

1.1 General description

180 W LDMOS power transistor for base station applications at frequencies from 2000 MHz to 2200 MHz.

Table 1. Typical performance

RF performance at $T_{case} = 25\text{ }^{\circ}\text{C}$ in a common source class-AB production test circuit.

Mode of operation	f (MHz)	V _{DS} (V)	P _{L(AV)} (W)	G _p (dB)	η _D (%)	ACPR (dBc)
2-carrier W-CDMA	2110 to 2170	32	50	17.5	27.5	-35 ^[1]

[1] Test signal: 3GPP; test model 1; 64 DPCH; PAR = 7.5 dB at 0.01 % probability on CCDF per carrier; carrier spacing 5 MHz.

CAUTION



This device is sensitive to ElectroStatic Discharge (ESD). Therefore care should be taken during transport and handling.

1.2 Features

- Typical 2-carrier W-CDMA performance at frequencies of 2110 MHz and 2170 MHz, a supply voltage of 32 V and an I_{DQ} of 1600 mA:
 - ◆ Average output power = 50 W
 - ◆ Power gain = 17.5 dB (typ)
 - ◆ Efficiency = 27.5 %
 - ◆ ACPR = -35 dBc
- Easy power control
- Integrated ESD protection
- Excellent ruggedness
- High efficiency
- Excellent thermal stability
- Designed for broadband operation (2000 MHz to 2200 MHz)
- Internally matched for ease of use
- Qualified up to a supply voltage of 32 V
- Compliant to Directive 2002/95/EC, regarding Restriction of Hazardous Substances (RoHS)

1.3 Applications

- RF power amplifiers for W-CDMA base stations and multicarrier applications in the 2000 MHz to 2200 MHz frequency range

2. Pinning information

Table 2. Pinning

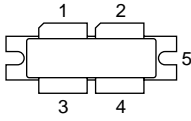
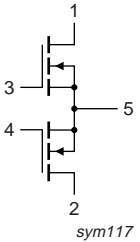
Pin	Description	Simplified outline	Graphic symbol
1	drain1		
2	drain2		
3	gate1		
4	gate2		
5	source		

[1] Connected to flange.

3. Ordering information

Table 3. Ordering information

Type number	Package		
	Name	Description	Version
BLF6G22-180PN	-	flanged balanced LDMOST ceramic package; 2 mounting holes; 4 leads	SOT539A

4. Limiting values

Table 4. Limiting values

In accordance with the Absolute Maximum Rating System (IEC 60134).

Symbol	Parameter	Conditions	Min	Max	Unit
V_{DS}	drain-source voltage		-	65	V
V_{GS}	gate-source voltage		-0.5	+13	V
T_{stg}	storage temperature		-65	+150	°C
T_{case}	case temperature		-	150	°C
T_j	junction temperature		-	225	°C

5. Thermal characteristics

Table 5. Thermal characteristics

Symbol	Parameter	Conditions	Typ	Unit
$R_{th(j-case)}$	thermal resistance from junction to case	$T_{case} = 80\text{ °C}; P_{L(AV)} = 50\text{ W}$	0.45	K/W

6. Characteristics

Table 6. Characteristics

$T_j = 25\text{ }^\circ\text{C}$ per section; unless otherwise specified.

Symbol	Parameter	Conditions	Min	Typ	Max	Unit
$V_{(BR)DSS}$	drain-source breakdown voltage	$V_{GS} = 0\text{ V}; I_D = 0.5\text{ mA}$	65	-	-	V
$V_{GS(th)}$	gate-source threshold voltage	$V_{DS} = 10\text{ V}; I_D = 144\text{ mA}$	1.575	1.9	2.3	V
V_{GSq}	gate-source quiescent voltage	$V_{DS} = 32\text{ V}; I_D = 800\text{ mA}$	1.725	2.1	2.45	V
I_{DSS}	drain leakage current	$V_{GS} = 0\text{ V}$				
		$V_{DS} = 28\text{ V}$	-	-	3	μA
		$V_{DS} = 60\text{ V}$	-	-	5	μA
I_{DSX}	drain cut-off current	$V_{GS} = V_{GS(th)} + 3.75\text{ V};$ $V_{DS} = 10\text{ V}$	-	25	-	A
I_{GSS}	gate leakage current	$V_{GS} = 11\text{ V}; V_{DS} = 0\text{ V}$	-	-	300	nA
g_{fs}	forward transconductance	$V_{DS} = 10\text{ V}; I_D = 7.2\text{ A}$	-	10	-	S
$R_{DS(on)}$	drain-source on-state resistance	$V_{GS} = V_{GS(th)} + 3.75\text{ V};$ $I_D = 5\text{ A}$	-	0.1	0.165	Ω

7. Application information

Table 7. Application information

Mode of operation: 2-carrier W-CDMA; PAR 7.5 dB at 0.01 % probability on CCDF; 3GPP test model 1; 1 to 64 PDPCH; $f_1 = 2112.5\text{ MHz}; f_2 = 2117.5\text{ MHz}; f_3 = 2162.5\text{ MHz}; f_4 = 2167.5\text{ MHz};$ RF performance at $V_{DS} = 32\text{ V}; I_{Dq} = 1600\text{ mA}; T_{case} = 25\text{ }^\circ\text{C};$ unless otherwise specified; in a class-AB production test circuit.

Symbol	Parameter	Conditions	Min	Typ	Max	Unit
G_p	power gain	$P_{L(AV)} = 50\text{ W}$	16.3	17.5	18.7	dB
RL_{in}	input return loss	$P_{L(AV)} = 50\text{ W}$	-	-10	-6.5	dB
η_D	drain efficiency	$P_{L(AV)} = 50\text{ W}$	25	27.5	-	%
ACPR	adjacent channel power ratio	$P_{L(AV)} = 50\text{ W}$	-	-35	-33	dBc

Table 8. Application information

Mode of operation: 1-carrier W-CDMA; PAR 7.5 dB at 0.01 % probability on CCDF; 3GPP test model 1; 1 to 64 PDPCH; $f_1 = 2162.5\text{ MHz}; f_2 = 2167.5\text{ MHz};$ RF performance at $V_{DS} = 32\text{ V}; I_{Dq} = 1600\text{ mA}; T_{case} = 25\text{ }^\circ\text{C};$ unless otherwise specified; in a class-AB production test circuit.

Symbol	Parameter	Conditions	Min	Typ	Max	Unit
PAR_O	output peak-to-average ratio	$P_{L(AV)} = 115\text{ W};$ at 0.01 % probability on CCDF	4.05	4.5	-	dB

7.1 Ruggedness in class-AB operation

The BLF6G22-180PN is capable of withstanding a load mismatch corresponding to $VSWR = 10 : 1$ through all phases under the following conditions: $V_{DS} = 28\text{ V}; I_{Dq} = 1600\text{ mA}; P_L = 180\text{ W (CW)}; f = 2170\text{ MHz}.$

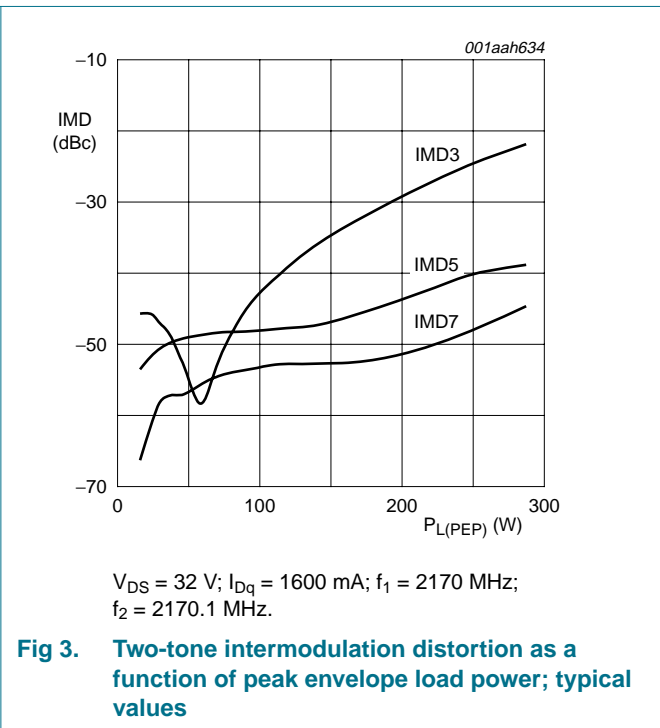
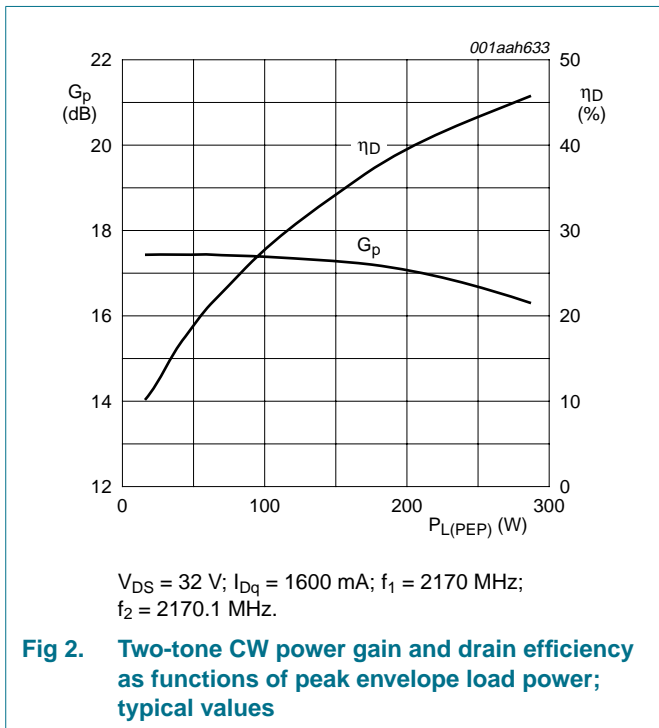
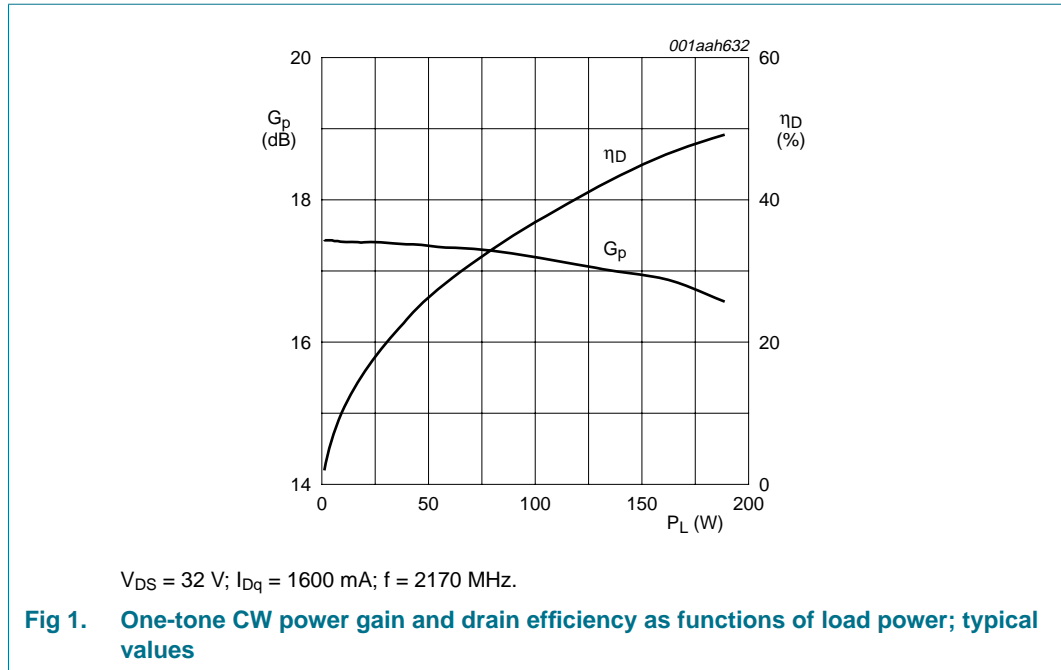

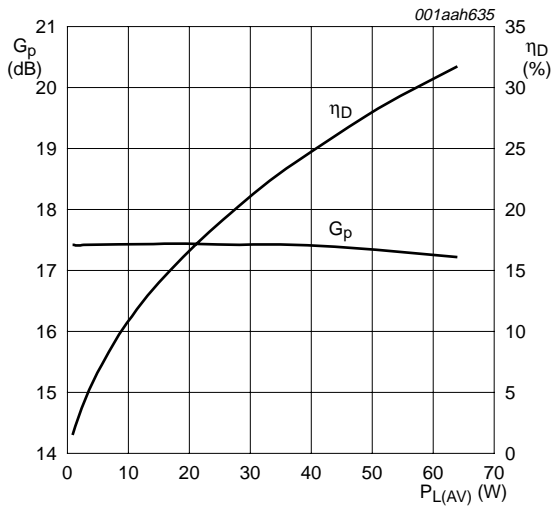

$V_{DS} = 32$ V; $I_{Dq} = 1600$ mA; $f_1 = 2162.5$ MHz; $f_2 = 2167.5$ MHz; carrier spacing 5 MHz.

Fig 4. 2-carrier W-CDMA power gain and drain efficiency as functions of average load power; typical values

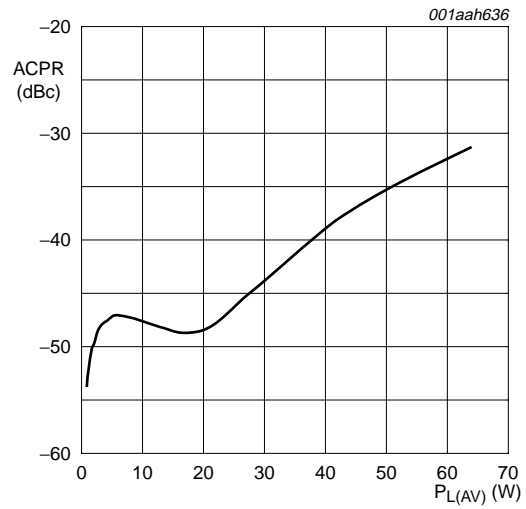

$V_{DS} = 32$ V; $I_{Dq} = 1600$ mA; $f_1 = 2162.5$ MHz; $f_2 = 2167.5$ MHz; carrier spacing 5 MHz.

Fig 5. 2-carrier W-CDMA adjacent channel power ratio as function of average load power; typical values

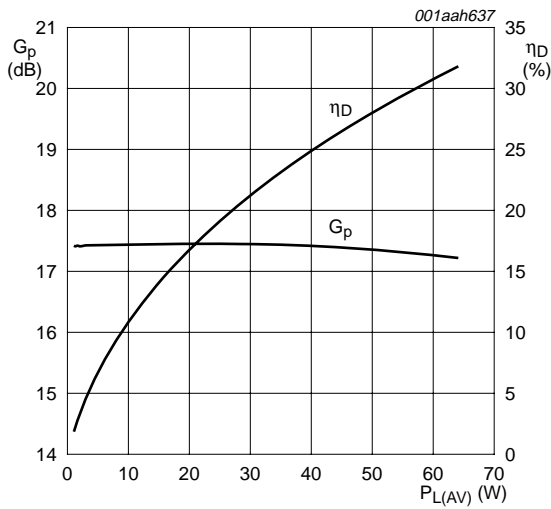

$V_{DS} = 32$ V; $I_{Dq} = 1600$ mA; $f_1 = 2157.5$ MHz; $f_2 = 2167.5$ MHz; carrier spacing 10 MHz.

Fig 6. 2-carrier W-CDMA power gain and drain efficiency as functions of average load power; typical values

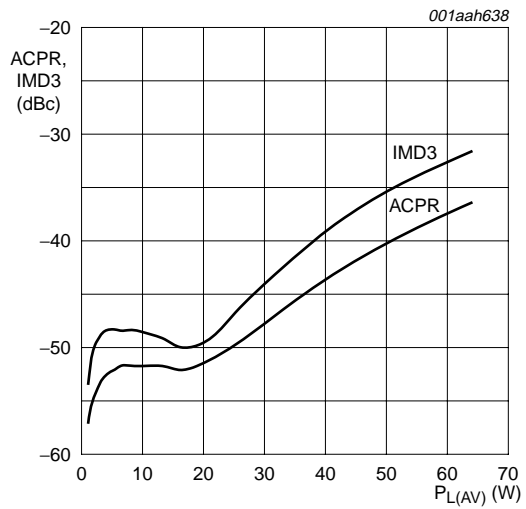

$V_{DS} = 32$ V; $I_{Dq} = 1600$ mA; $f_1 = 2157.5$ MHz; $f_2 = 2167.5$ MHz; carrier spacing 10 MHz.

Fig 7. 2-carrier W-CDMA adjacent channel power ratio and third order intermodulation distortion as functions of average load power; typical values

8. Test information

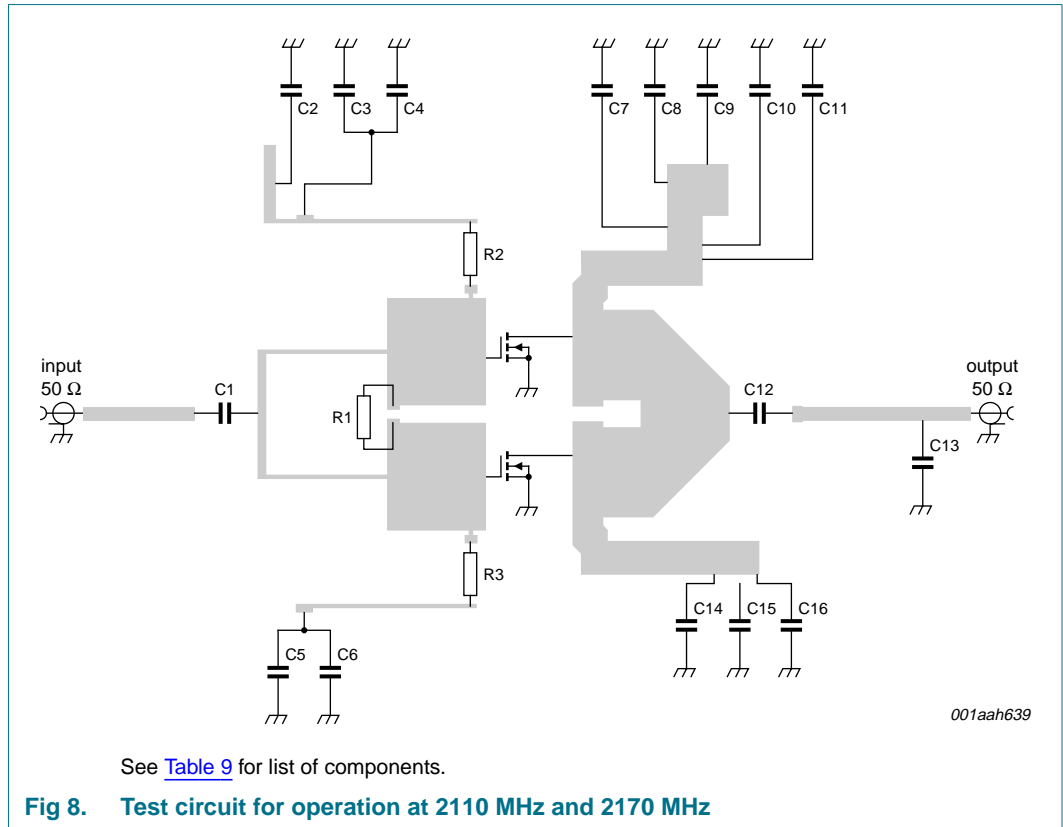

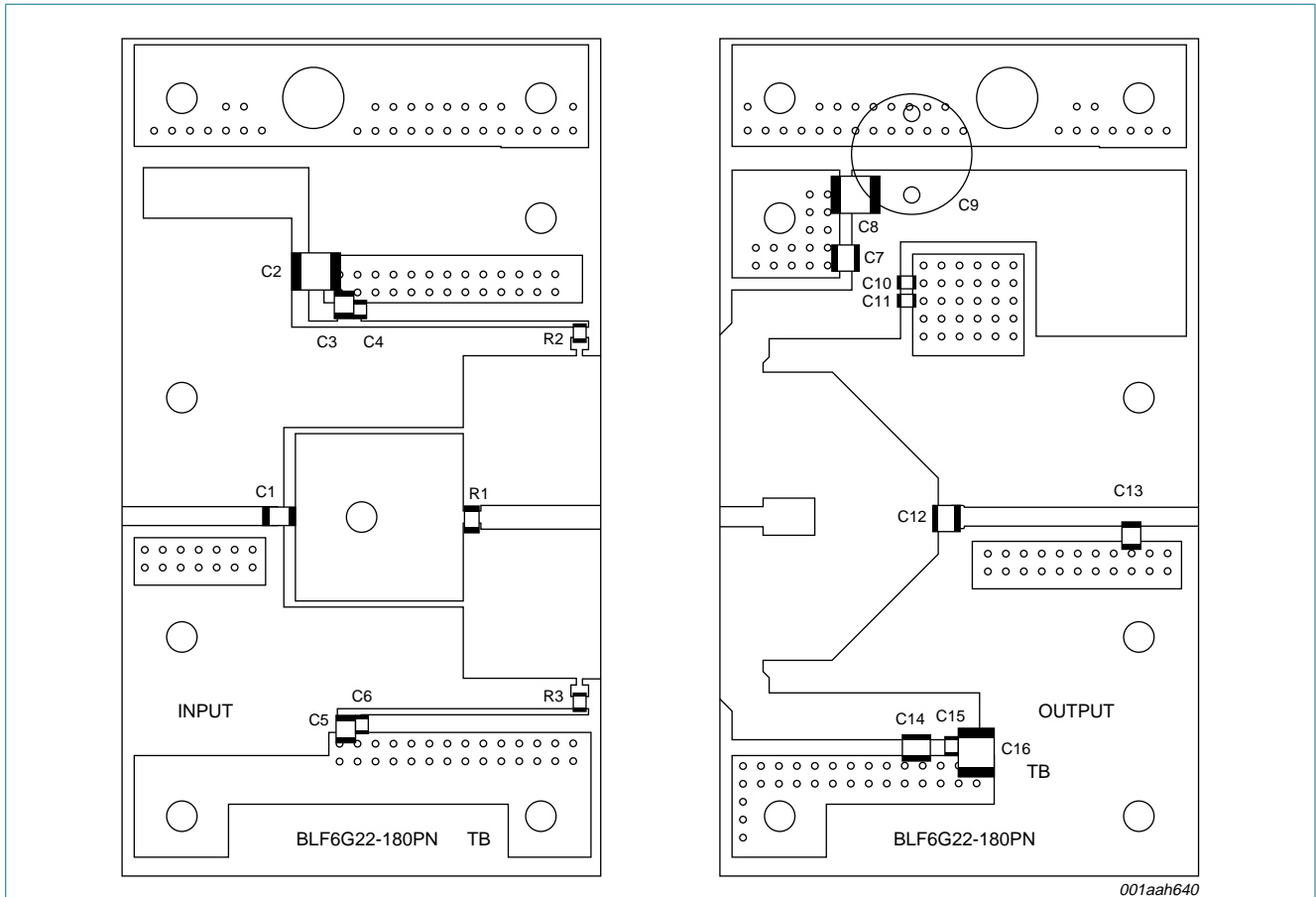

Striplines are on a double copper-clad Rogers R04350 Printed-Circuit Board (PCB) with $\epsilon_r = 3.5$ and thickness = 0.76 mm. See [Table 9](#) for list of components.

Fig 9. Component layout for 2110 MHz and 2170 MHz test circuit

Table 9. List of components
For test circuit, see [Figure 8](#) and [Figure 9](#).

Component	Description	Value	Remarks
C1, C3, C5	ATC multilayer ceramic chip capacitor	10 pF	[1]
C2, C8, C16	TDK multilayer ceramic chip capacitor	4.7 μ F	
C4, C6	TDK multilayer ceramic chip capacitor	220 nF	
C7, C14	ATC multilayer ceramic chip capacitor	10 pF	[2]
C9	electrolytic capacitor	220 μ F; 63 V	
C10, C11, C15	Murata ceramic chip capacitor	100 nF	
C12	ATC multilayer ceramic chip capacitor	15 pF	[2]
C13	ATC multilayer ceramic chip capacitor	0.3 pF	[1]
R1	chip resistor	33 Ω	
R2, R3	chip resistor	5.6 Ω	

[1] American technical ceramics type 100B or capacitor of same quality.
 [2] American technical ceramics type 180R or capacitor of same quality.

9. Package outline

Flanged balanced LDMOST ceramic package; 2 mounting holes; 4 leads

SOT539A

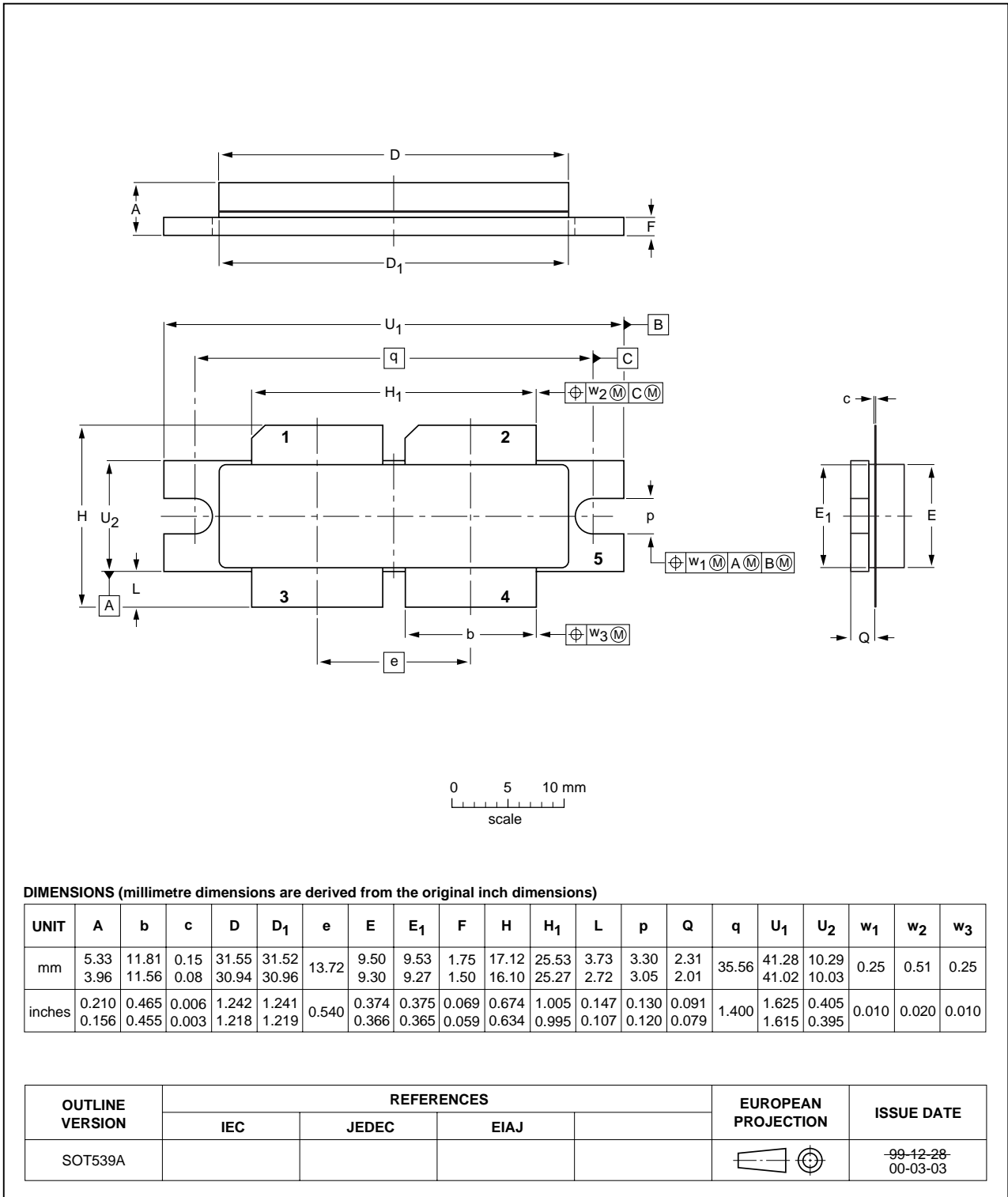

Fig 10. Package outline SOT539A

10. Abbreviations

Table 10. Abbreviations

Acronym	Description
3GPP	3rd Generation Partnership Project
CCDF	Complementary Cumulative Distribution Function
CW	Continuous Wave
DPCH	Dedicated Physical CHannel
IMD	InterModulation Distortion
LDMOS	Laterally Diffused Metal-Oxide Semiconductor
LDMOST	Laterally Diffused Metal-Oxide Semiconductor Transistor
PAR	Peak-to-Average power Ratio
PDPCH	transmission Power of the Dedicated Physical CHannel
RF	Radio Frequency
VSWR	Voltage Standing-Wave Ratio
W-CDMA	Wideband Code Division Multiple Access

11. Revision history

Table 11. Revision history

Document ID	Release date	Data sheet status	Change notice	Supersedes
BLF6G22-180PN_2	20080423	Product data sheet	-	BLF6G22-180PN_1
BLF6G22-180PN_1	20080221	Preliminary data sheet	-	-

12. Legal information

12.1 Data sheet status

Document status ^{[1][2]}	Product status ^[3]	Definition
Objective [short] data sheet	Development	This document contains data from the objective specification for product development.
Preliminary [short] data sheet	Qualification	This document contains data from the preliminary specification.
Product [short] data sheet	Production	This document contains the product specification.

[1] Please consult the most recently issued document before initiating or completing a design.

[2] The term 'short data sheet' is explained in section "Definitions".

[3] The product status of device(s) described in this document may have changed since this document was published and may differ in case of multiple devices. The latest product status information is available on the Internet at URL <http://www.nxp.com>.

12.2 Definitions

Draft — The document is a draft version only. The content is still under internal review and subject to formal approval, which may result in modifications or additions. NXP Semiconductors does not give any representations or warranties as to the accuracy or completeness of information included herein and shall have no liability for the consequences of use of such information.

Short data sheet — A short data sheet is an extract from a full data sheet with the same product type number(s) and title. A short data sheet is intended for quick reference only and should not be relied upon to contain detailed and full information. For detailed and full information see the relevant full data sheet, which is available on request via the local NXP Semiconductors sales office. In case of any inconsistency or conflict with the short data sheet, the full data sheet shall prevail.

12.3 Disclaimers

General — Information in this document is believed to be accurate and reliable. However, NXP Semiconductors does not give any representations or warranties, expressed or implied, as to the accuracy or completeness of such information and shall have no liability for the consequences of use of such information.

Right to make changes — NXP Semiconductors reserves the right to make changes to information published in this document, including without limitation specifications and product descriptions, at any time and without notice. This document supersedes and replaces all information supplied prior to the publication hereof.

Suitability for use — NXP Semiconductors products are not designed, authorized or warranted to be suitable for use in medical, military, aircraft, space or life support equipment, nor in applications where failure or

malfunction of an NXP Semiconductors product can reasonably be expected to result in personal injury, death or severe property or environmental damage. NXP Semiconductors accepts no liability for inclusion and/or use of NXP Semiconductors products in such equipment or applications and therefore such inclusion and/or use is at the customer's own risk.

Applications — Applications that are described herein for any of these products are for illustrative purposes only. NXP Semiconductors makes no representation or warranty that such applications will be suitable for the specified use without further testing or modification.

Limiting values — Stress above one or more limiting values (as defined in the Absolute Maximum Ratings System of IEC 60134) may cause permanent damage to the device. Limiting values are stress ratings only and operation of the device at these or any other conditions above those given in the Characteristics sections of this document is not implied. Exposure to limiting values for extended periods may affect device reliability.

Terms and conditions of sale — NXP Semiconductors products are sold subject to the general terms and conditions of commercial sale, as published at <http://www.nxp.com/profile/terms>, including those pertaining to warranty, intellectual property rights infringement and limitation of liability, unless explicitly otherwise agreed to in writing by NXP Semiconductors. In case of any inconsistency or conflict between information in this document and such terms and conditions, the latter will prevail.

No offer to sell or license — Nothing in this document may be interpreted or construed as an offer to sell products that is open for acceptance or the grant, conveyance or implication of any license under any copyrights, patents or other industrial or intellectual property rights.

12.4 Trademarks

Notice: All referenced brands, product names, service names and trademarks are the property of their respective owners.

13. Contact information

For more information, please visit: <http://www.nxp.com>

For sales office addresses, please send an email to: salesaddresses@nxp.com

14. Contents

1 Product profile 1

1.1 General description 1

1.2 Features 1

1.3 Applications 2

2 Pinning information 2

3 Ordering information 2

4 Limiting values 2

5 Thermal characteristics 2

6 Characteristics 3

7 Application information 3

7.1 Ruggedness in class-AB operation 3

8 Test information 6

9 Package outline 8

10 Abbreviations 9

11 Revision history 9

12 Legal information 10

12.1 Data sheet status 10

12.2 Definitions 10

12.3 Disclaimers 10

12.4 Trademarks 10

13 Contact information 10

14 Contents 11

Please be aware that important notices concerning this document and the product(s) described herein, have been included in section 'Legal information'.



© NXP B.V. 2008.

All rights reserved.

For more information, please visit: <http://www.nxp.com>

For sales office addresses, please send an email to: salesaddresses@nxp.com

Date of release: 23 April 2008

Document identifier: BLF6G22-180PN_2