



EVERLIGHT ELECTRONICS CO.,LTD.

Device Number : DLE-020-065 REV: 2.1

3mm Round Standard LEDs, T-1

MODEL NO : 204GT ECN : _____ Page: 1/4

Features :

- High luminous power.
- Can be driven at low current.
- 2.54mm lead spacing.
- Available on tape and reel.

Descriptions :

- The series is specially designed for applications require higher brightness than that achievable with standard lamp.
- The LED lamps are available with different colors,intensities, epoxy colors, etc.

Package Dimensions:

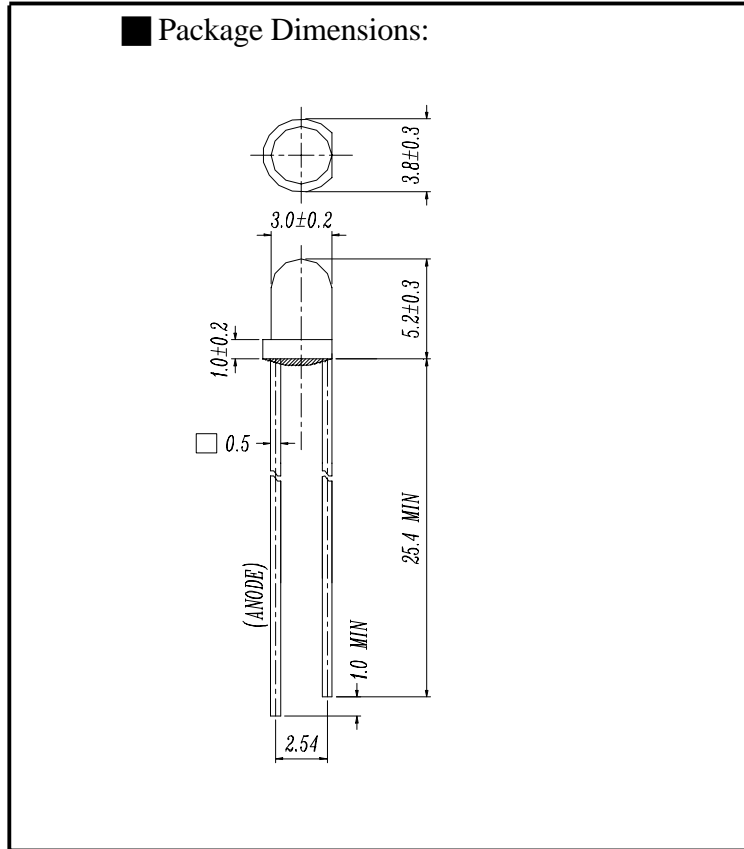

Applications :

- TV Set
- Monitor
- Telephone
- Computer

Notes :

- 1.All dimensions are in millimeters.
- 2.An epoxy meniscus may extend about 1.5mm(0.059") down to the lead.

PART NO	Chip		Lens Color
	Material	Emitted Color	
204GT	GaP	Green	Green Trans

OFFICE : NO. 25,Lane 76,Sec.3, Chung Yang Rd., Tucheng 236, Taipei, Taiwan, R.O.C.

TEL : 886-2-2267-2000,2267-9936

FAX : 886-2-2267-6244,22676189,22676306

<http://www.everlight.com>



EVERLIGHT ELECTRONICS CO.,LTD.

Device Number : DLE-020-065 REV: 2.1

3mm Round Standard LEDs, T-1

MODEL NO : 204GT ECN : _____ Page: 2/4

■ Absolute Maximum Ratings at Ta = 25°C

Parameter	Symbol	Rating	Unit
Forward Current	If	30	mA
Operating Temperature	Topr	-40 to +85	°C
Storage Temperature	Tstg	-40 to +100	°C
Soldering Temperature	Tsol	260 ± 5	°C
Power Dissipation	Pd	100	mW
Peak Forward Current(Duty 1/10 @ 1KHZ)	If(Peak)	160	mA
Reverse Voltage	Vr	5	V

■ Electronic Optical Characteristics :

Parameter	Symbol	MIN.	TYP.	MAX.	Unit	Condition
Luminous intensity	Iv	25	40	----	mcd	If=10mA
Viewing Angle	2θ 1/2	----	30	----	deg	If=20mA
Peak Wavelength	λ p	----	565	----	nm	If=20mA
Dominant Wavelength	λ d	-----	570	----	nm	If=20mA
Spectrum Radiation Bandwidth	△ λ	----	30	----	nm	If=20mA
Forward Voltage	Vf	1.7	2.1	2.4	V	If=20mA
Reverse Current	Ir	----	----	10	μ A	Vr=5V



Device Number : DLE-020-065 REV: 2.1

3mm Round Standard LEDs, T-1

MODEL NO 204GT ECN : _____ Page: 3/4

■ Typical Electro-Optical Characteristic Curves

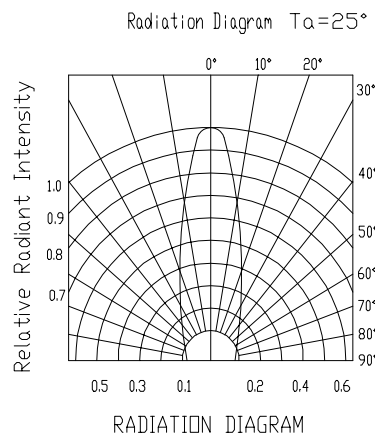
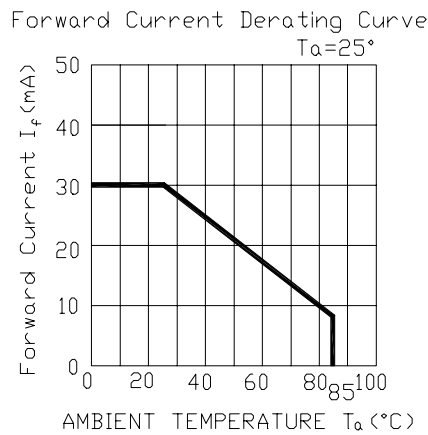
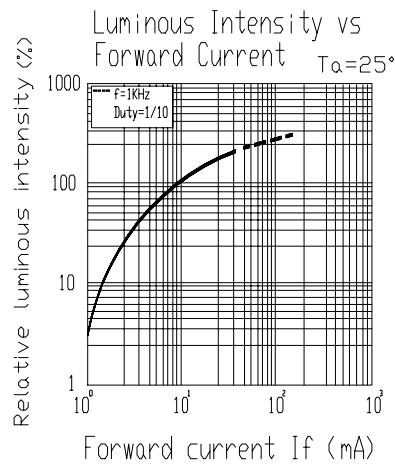
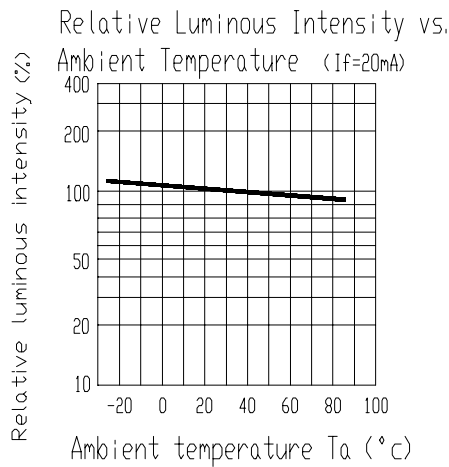
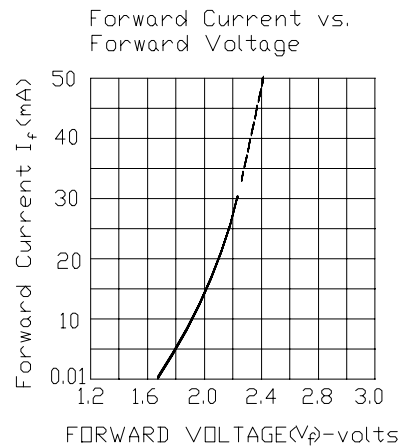
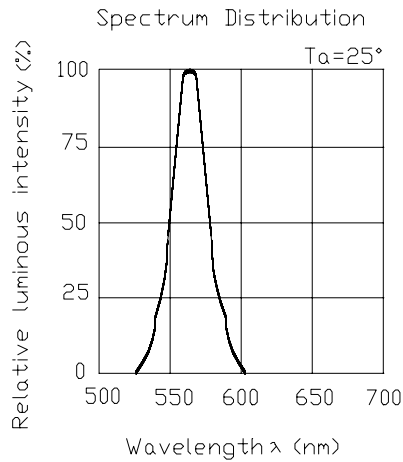



EVERLIGHT ELECTRONICS CO.,LTD.

Device Number : DLE-020-065 REV: 2.1

3mm Round Standard LEDs, T-1

MODEL NO 204GT ECN : Page: 4/4

■ Reliability test items and conditions

NO	Item	Test Conditions	Test Hours/Cycle	Sample Size	Ac/Re
1	Soldering Heat	TEMP : 260°C ± 5 °C	5 SEC	76 Pcs	0/1
2	Temperature Cycle	H : +85°C 30min ∫ 5 min L : -55°C 30min	50 CYCLE	76 Pcs	0/1
3	Thermal Shock	H : +100°C 5min ∫ 10 sec L : -10°C 5min	50 CYCLE	76 Pcs	0/1
4	High Temperature Storage	TEMP : 100°C	1000 HRS	76 Pcs	0/1
5	Low Temperature Storage	TEMP : -55°C	1000 HRS	76 Pcs	0/1
6	DC Operating Life	If = 20 mA	1000 HRS	76 Pcs	0/1
7	High Temperature / High Humidity	85°C/85% RH	1000 HRS	76 Pcs	0/1