

**PLEASE CHECK WWW.MOLEX.COM FOR LATEST PART INFORMATION**

**Part Number:** [5013290214](#)  
**Status:** **Active**  
**Overview:** [inertia lock 330mm wiretowire system](#)  
**Description:** 3.30mm (.130") Pitch Wire-to-Wire Inertia Lock Plug Housing, Single Row, 2 Circuits, Blue

**Documents:**

[Drawing \(PDF\)](#) [RoHS Certificate of Compliance \(PDF\)](#)  
[Product Specification PS-501328-001 \(PDF\)](#)

**General**

Product Family	Crimp Housings
Series	<a href="#">501329</a>
Overview	<a href="#">inertia lock 330mm wiretowire system</a>
Product Name	Inertia Lock

**Physical**

Circuits (maximum)	2
Color - Resin	Blue
Gender	Male
Glow-Wire Compliant	No
Lock to Mating Part	Yes
Material - Resin	Nylon
Number of Rows	1
Packaging Type	Bag
Panel Mount	No
Pitch - Mating Interface (in)	0.130 In
Pitch - Mating Interface (mm)	3.30 mm
Polarized to Mating Part	Yes
Stackable	No
Temperature Range - Operating	-25°C to +80°C

**Electrical**

Current - Maximum per Contact	4A
-------------------------------	----

**Material Info**

**Reference - Drawing Numbers**

Packaging Specification	SPK-501329-001
Product Specification	PS-501328-001, RPS-501328-001, RPS-501328-002, RPS-501328-003
Sales Drawing	SD-501329-001

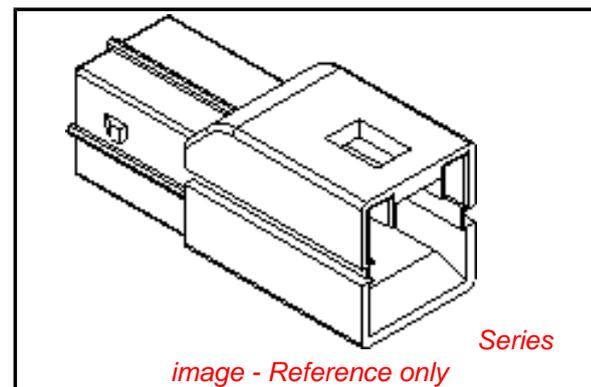

**EU RoHS**

**ELV and RoHS Compliant**  
**REACH SVHC**  
 Not Reviewed  
**Halogen-Free Status**  
 Not Reviewed

**China RoHS**



**Need more information on product environmental compliance?**

Email [productcompliance@molex.com](mailto:productcompliance@molex.com)  
 For a multiple part number RoHS Certificate of Compliance, [click here](#)

Please visit the [Contact Us](#) section for any non-product compliance questions.

**Search Parts in this Series**

[501329Series](#)

**Mates With**

[501328-0214](#) Receptacle Housing . [501395](#) Receptacle Terminal for AWG#18-20 . [500989](#) Receptacle Terminal for AWG#22-26

**Use With**

[51348-0213](#) Retainer . [56265](#) Plug Terminal for AWG#18- 20 . [56279](#) Plug Terminal for AWG#22-26

10 9 8 7 6 5 4 3 2 1

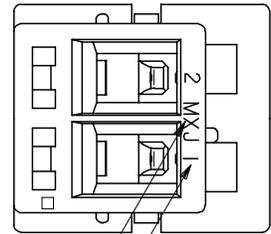

トレードマーク  
TRADE MARK.

回路番号  
CKT No.

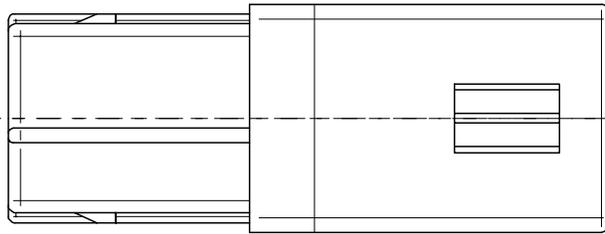

24.5

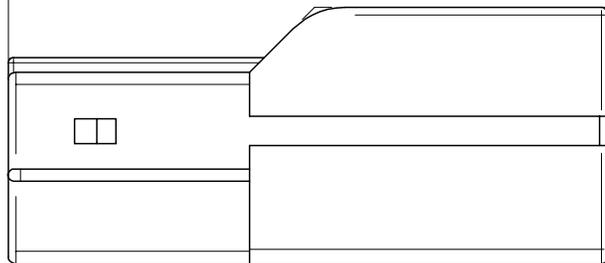

10.45

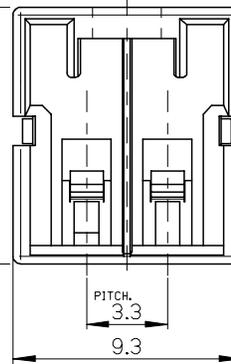

PITCH  
3.3  
9.3

注記  
NOTES.

- △ 適合リテーナ : 51348-0213  
APPLICABLE RETAINER  
詳細は SD-51348-001 を参照下さい。  
REFERENCE:SD-51348-001
- 2. 材料 : NYLON66,UL94V-0  
MATERIAL

本形状は 501329-0200 を示す。  
SHAPE OF 501329-0200

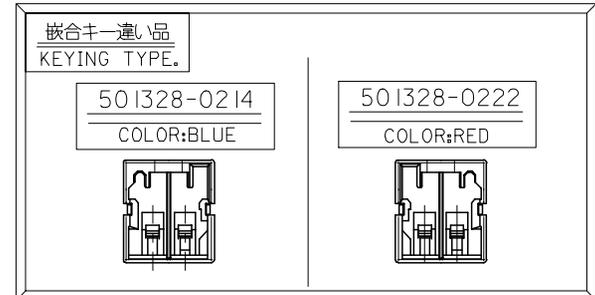
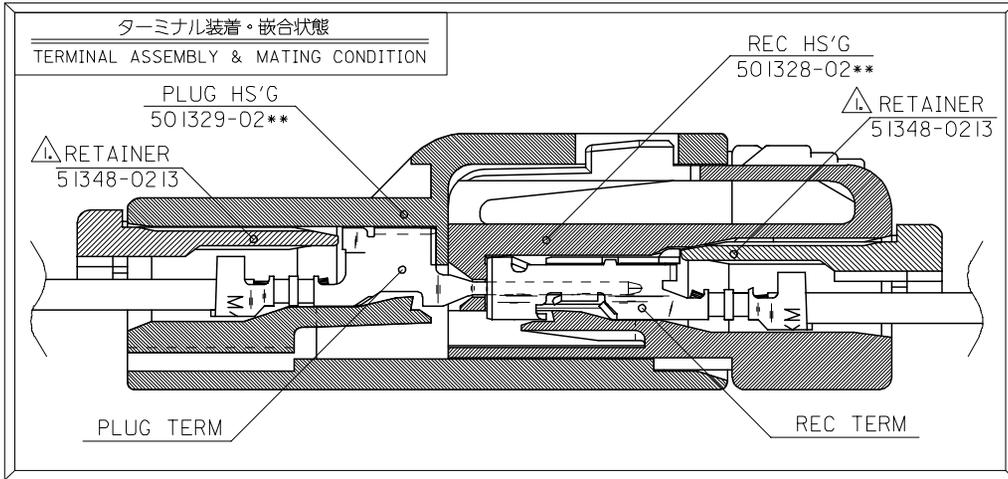

BLUE	501329-0214	501329-02**
RED	501329-0222	
WHITE	501329-0200	
COLOR	MATERIAL No.	MODEL No.

RELEASED EC NO: J2005-2177 DRWN:TODA 2005/03/31 CHKDK:ASAKAWA 2005/03/31 APPR:S.ICHIKAWA 2005/03/31	GENERAL TOLERANCES (UNLESS SPECIFIED)		DIMENSION STYLE MM ONLY		SCALE 5:1	DESIGN UNITS METRIC	THIRD ANGLE PROJECTION
	10 UNDER	±0.2	DRAWN BY T.ODA	DATE '04/09/30	TITLE 3.3 W/W INERTIA LOCK CONN PLUG 2CKT		
	10 OVER 30 UNDER	±0.25	CHECKED BY K.ASAKAWA	DATE '04/09/30	APPROVED BY S.ICHIKAWA		
	30 OVER	±0.3	DATE '04/09/30	MATERIAL NO.			
	ANGULAR	±3 °	DRAFT WHERE APPLICABLE MUST REMAIN WITHIN DIMENSIONS		SEE CHART	DOCUMENT NO. SD-501329-001	SHEET NO. 1 OF 1