

PLEASE CHECK WWW.MOLEX.COM FOR LATEST PART INFORMATION

Part Number: [0459846161](#)
Status: **Active**
Overview: [extreme_lphpower](#)
Description: 1.27mm (.050"), 12.00mm (.472") Pitch, EXTreme LPHPower™ Receptacle Header, Right Angle, 6 Power Contacts, 32 Signal Contacts, Select Gold (Au) Plating, for 3.18mm (.125") Thick PC Board

Documents:

[3D Model](#) [Product Specification PS-45984-001 \(PDF\)](#)
[Drawing \(PDF\)](#) [RoHS Certificate of Compliance \(PDF\)](#)

Agency Certification

CSA LR19980
 UL E29179

General

Product Family PCB Receptacles
 Series [45984](#)
 Application Board-to-Board
 Overview [extreme_lphpower](#)
 Product Name EXTreme LPHPower™

Physical

Circuits (Loaded) 38
 Circuits (maximum) 38
 Circuits Detail 6 Power, 32 Signal
 Color - Resin Black
 Durability (mating cycles max) 250
 Flammability 94V-0
 Glow-Wire Compliant No
 Guide to Mating Part No
 Keying to Mating Part Yes
 Lock to Mating Part No
 Material - Metal High Performance Alloy (HPA), Phosphor Bronze
 Material - Plating Mating Gold
 Material - Plating Termination Tin
 Material - Resin High Temperature Thermoplastic
 Number of Rows 2
 Orientation Right Angle
 PC Tail Length (in) 0.177 In
 PC Tail Length (mm) 4.50 mm
 PCB Locator No
 PCB Retention None
 PCB Thickness Recommended (in) 0.125 In
 PCB Thickness Recommended (mm) 3.18 mm
 Packaging Type Tray
 Pitch - Mating Interface (in) 0.050 In, 0.472 In
 Pitch - Mating Interface (mm) 1.27 mm, 12.00 mm
 Plating min: Mating (µin) 30
 Plating min: Mating (µm) 0.75
 Plating min: Termination (µin) 150, 75
 Plating min: Termination (µm) 1.875, 3.75
 Polarized to Mating Part Yes
 Polarized to PCB Yes
 Stackable No
 Surface Mount Compatible (SMC) Yes

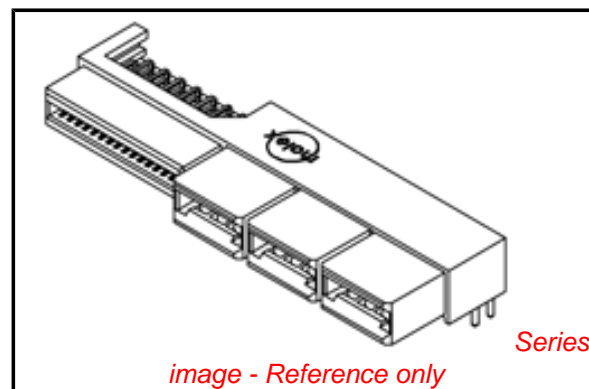

EU RoHS

ELV and RoHS Compliant
REACH SVHC Contains SVHC: No
Halogen-Free Status

China RoHS



Need more information on product environmental compliance?

Email productcompliance@molex.com
 For a multiple part number RoHS Certificate of Compliance, [click here](#)

Please visit the [Contact Us](#) section for any non-product compliance questions.

Search Parts in this Series

[45984Series](#)

Mates With

[45985](#) EXTreme LPHPower™ Headers, 1.57mm (.062") Card Edge

Temperature Range - Operating -40°C to +105°C
Termination Interface: Style Through Hole

Electrical

Current - Maximum per Contact 27A
Grounding to PCB No
Voltage - Maximum 250V AC (RMS)/DC

Solder Process Data

Duration at Max. Process Temperature (seconds) 20
Lead-free Process Capability Wave Capable (TH only)
Max. Cycles at Max. Process Temperature 3
Process Temperature max. C 260

Material Info

Reference - Drawing Numbers

Packaging Specification PK-45984-001
Product Specification PS-45984-001
Sales Drawing SD-45984-600

This document was generated on 05/31/2010

PLEASE CHECK WWW.MOLEX.COM FOR LATEST PART INFORMATION



- NOTES:
1. MATERIAL HOUSING: LCP, 94V-0, COLOR-BLACK.
CONTACT: COPPER ALLOY.
 2. FINISH: SELECT GOLD - .76µM/30 MI MIN. CONTACT AREA.
SELECT TIN - 3.81µM/150 MI MIN. TAIL AREA.
BOTH OVER NICKEL - 1.27µM/50 MI MIN.
 3. POWER TERMINALS LUBRICATED IN CONTACT AREA.
 4. PRODUCT SPECIFICATION: PS-45984-001.
 5. PACKAGING: TRAY PER PK-45984-001.
 6. SEE SHEET 5 FOR CKT IDENTIFICATION.
 7. PARTS ARE RoHS COMPLIANT.
 8. PEG HOLES ARE OPTIONAL - SEE SHEETS 3 & 4.
 9. MATES TO 1.57/.062 CARD EDGE OR MOLEX P/N 45985-6***.

NO OF SIGNAL	MATERIAL NUMBER	DIM A	DIM P	PCB THK
12	45984-6111	47.5	4.50	3.18
16	45984-6121	50.0		
20	45984-6131	52.6		
24	45984-6141	55.1		
28	45984-6151	57.6		
32	45984-6161	60.2	3.60	2.36
36	45984-6171	62.7		
40	45984-6181	65.3		
12	45984-6112	47.5		
16	45984-6122	50.0		
20	45984-6132	52.6	2.90	1.57
24	45984-6142	55.1		
28	45984-6152	57.6		
32	45984-6162	60.2		
36	45984-6172	62.7		
40	45984-6182	65.3		
12	45984-6113	47.5	2.90	1.57
16	45984-6123	50.0		
20	45984-6133	52.6		
24	45984-6143	55.1		
28	45984-6153	57.6		
32	45984-6163	60.2	2.90	1.57
36	45984-6173	62.7		
40	45984-6183	65.3		

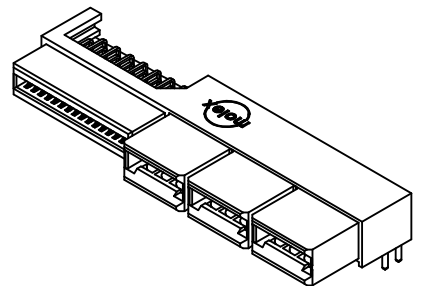
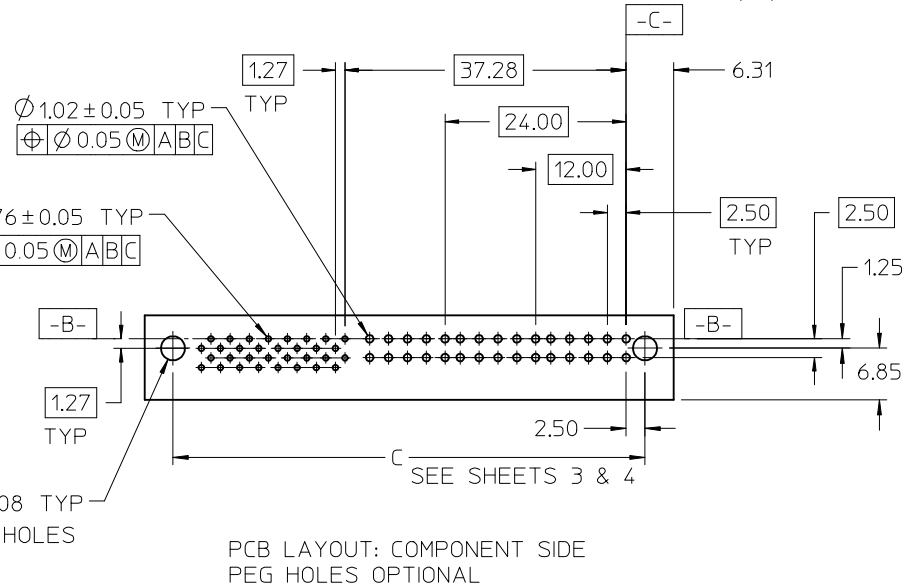
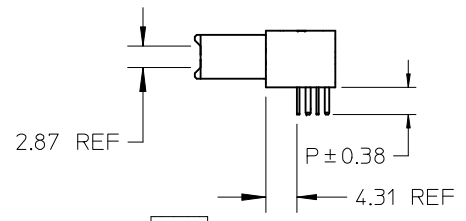
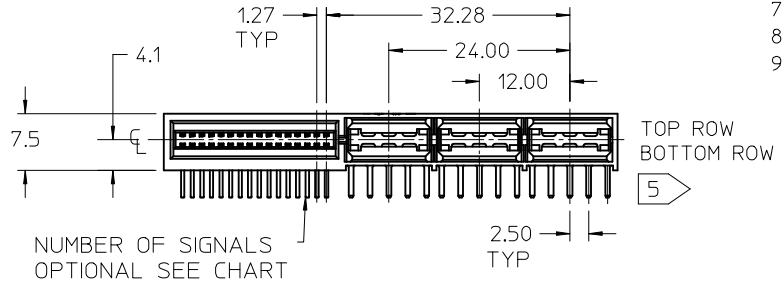

REVISED	DESCRIPTION
EC NO: UCP2009-0971	2008/11/13
DRWN:MBANDURA	2008/11/14
CHKD:	2008/11/14
APPR:APATEL	2008/11/17
REV	

GENERAL TOLERANCES (UNLESS SPECIFIED)	
	mm INCH
4 PLACES	± --- ± ---
3 PLACES	± --- ± ---
2 PLACES	± 0.25 ± ---
1 PLACE	± --- ± ---
ANGULAR ± 1/2°	
DRAFT WHERE APPLICABLE MUST REMAIN WITHIN DIMENSIONS	

DIMENSION STYLE	
MM ONLY	
DRAWN BY	DATE
SAMIEC	2005/05/13
CHECKED BY	DATE
SAMIEC	2005/05/13
APPROVED BY	DATE
MARGULIS	2005/05/13
MATERIAL NO.	

SCALE	DESIGN UNITS	THIRD ANGLE PROJECTION	
1:1	METRIC		
TITLE			
LPH RECEPTACLE ASSEMBLY RT ANGLE 6 CIRCUIT POWER CONNECTOR			
MOLEX INCORPORATED			
DOCUMENT NO.			SHEET NO.
SD-45984-600			1 OF 5
THIS DRAWING CONTAINS INFORMATION THAT IS PROPRIETARY TO MOLEX INCORPORATED AND SHOULD NOT BE USED WITHOUT WRITTEN PERMISSION			

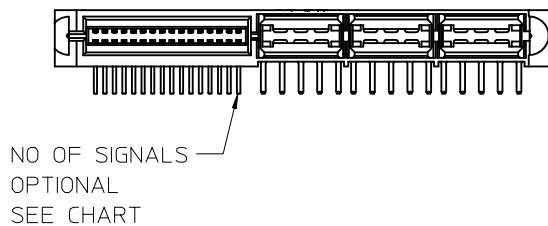
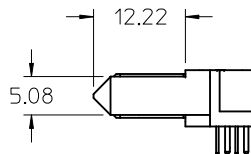
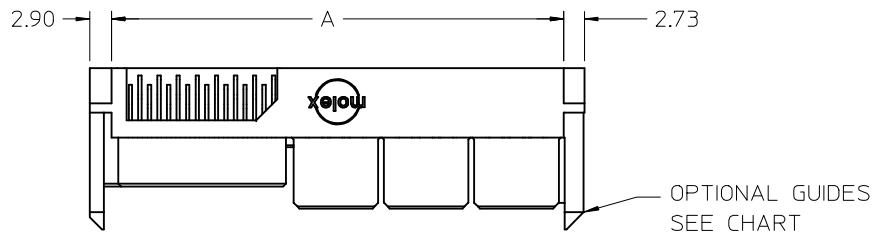

GUIDE POST OPTIONS

NO OF SIGNAL	MATERIAL NUMBER	DIM A	DIM P	PCB THK
12	45984-6211	47.5	4.50	3.18
16	45984-6221	50.0		
20	45984-6231	52.6		
24	45984-6241	55.1		
28	45984-6251	57.6		
32	45984-6261	60.2		
36	45984-6271	62.7	3.60	2.36
40	45984-6281	65.3		
12	45984-6212	47.5		
16	45984-6222	50.0		
20	45984-6232	52.6		
24	45984-6242	55.1		
28	45984-6252	57.6	2.90	1.57
32	45984-6262	60.2		
36	45984-6272	62.7		
40	45984-6282	65.3		
12	45984-6213	47.5		
16	45984-6223	50.0		
20	45984-6233	52.6		
24	45984-6243	55.1		
28	45984-6253	57.6		
32	45984-6263	60.2		
36	45984-6273	62.7		
40	45984-6283	65.3		

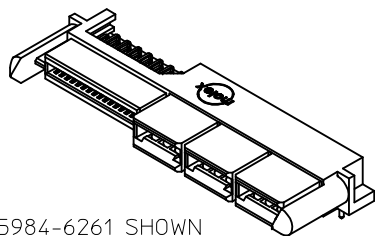

45984-6261 SHOWN
FOR REF ONLY
SEE CHART

REVISED	DESCRIPTION
EC NO: UCP2009-0971	
DRWN:MBANDURA 2008/11/13	
CHKD: 2008/11/14	
APPR:APATEL 2008/11/17	
REV	

GENERAL TOLERANCES
(UNLESS SPECIFIED)

	mm	INCH
4 PLACES	± ---	± ---
3 PLACES	± ---	± ---
2 PLACES	± 0.25	± ---
1 PLACE	± ---	± ---
ANGULAR ±1/2°		

DRAFT WHERE APPLICABLE
MUST REMAIN
WITHIN DIMENSIONS

DIMENSION STYLE
MM ONLY

DRAWN BY	DATE
SAMIEC	2005/05/13
CHECKED BY	DATE
SAMIEC	2005/05/13
APPROVED BY	DATE
MARGULIS	2005/05/13

MATERIAL NO.

SIZE
A

THIS DRAWING CONTAINS INFORMATION THAT IS PROPRIETARY TO MOLEX INCORPORATED AND SHOULD NOT BE USED WITHOUT WRITTEN PERMISSION

SCALE
1:1

DESIGN UNITS
METRIC

THIRD ANGLE
PROJECTION

TITLE
LPH RECEPTACLE ASSEMBLY
RT ANGLE 6 CIRCUIT
POWER CONNECTOR

molex MOLEX INCORPORATED

DOCUMENT NO.
SD-45984-600

SHEET NO.
2 OF 5

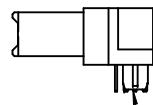
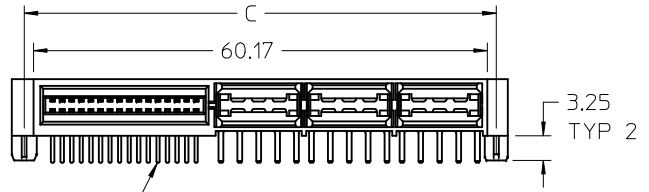
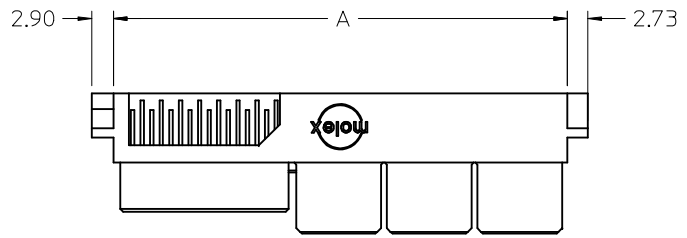

NO OF SIGNALS
OPTIONAL
SEE CHART

OPTIONAL PEGS

MOUNTING PEG OPTIONS

NO OF SIGNAL	MATERIAL NUMBER	DIM A	DIM C	DIM P	PCB THK
12	45984-6311	47.5	49.90	4.50	3.18
16	45984-6321	50.0	52.44		
20	45984-6331	52.6	54.98		
24	45984-6341	55.1	57.52		
28	45984-6351	57.6	60.06		
32	45984-6361	60.2	62.60		
36	45984-6371	62.7	65.14	3.60	2.36
40	45984-6381	65.3	67.68		
12	45984-6312	47.5	49.90		
16	45984-6322	50.0	52.44		
20	45984-6332	52.6	54.98		
24	45984-6342	55.1	57.52		
28	45984-6352	57.6	60.06	2.90	1.57
32	45984-6362	60.2	62.60		
36	45984-6372	62.7	65.14		
40	45984-6382	65.3	67.68		
12	45984-6313	47.5	49.90		
16	45984-6323	50.0	52.44		
20	45984-6333	52.6	54.98		
24	45984-6343	55.1	57.52		
28	45984-6353	57.6	60.06		
32	45984-6363	60.2	62.60		
36	45984-6373	62.7	65.14		
40	45984-6383	65.3	67.68		

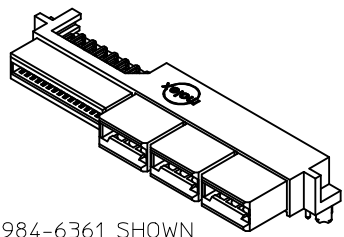

45984-6361 SHOWN
FOR REF ONLY
SEE CHART

REVISED EC NO: UCP2009-0971 DRWN:MBANDURA 2008/11/13 CHKD: 2008/11/14 APPR:APATEL 2008/11/17	DESCRIPTION	GENERAL TOLERANCES (UNLESS SPECIFIED)		DIMENSION STYLE MM ONLY		SCALE 1:1	DESIGN UNITS METRIC	THIRD ANGLE PROJECTION		
			mm	INCH	DRAWN BY SAMIEC	DATE 2005/05/13	TITLE LPH RECEPTACLE ASSEMBLY RT ANGLE 6 CIRCUIT POWER CONNECTOR			
		4 PLACES	± ---	± ---	CHECKED BY SAMIEC	DATE 2005/05/13				
		3 PLACES	± ---	± ---	APPROVED BY MARGULIS		DATE 2005/05/13	MOLEX INCORPORATED		
2 PLACES	± 0.25	± ---	MATERIAL NO.		DOCUMENT NO. SD-45984-600	SHEET NO. 3 OF 5				
		1 PLACE	± ---	± ---	DRAFT WHERE APPLICABLE MUST REMAIN WITHIN DIMENSIONS					
		ANGULAR ±1/2°		SIZE A		THIS DRAWING CONTAINS INFORMATION THAT IS PROPRIETARY TO MOLEX INCORPORATED AND SHOULD NOT BE USED WITHOUT WRITTEN PERMISSION				

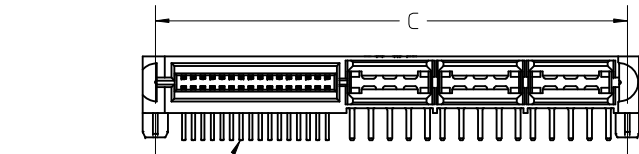
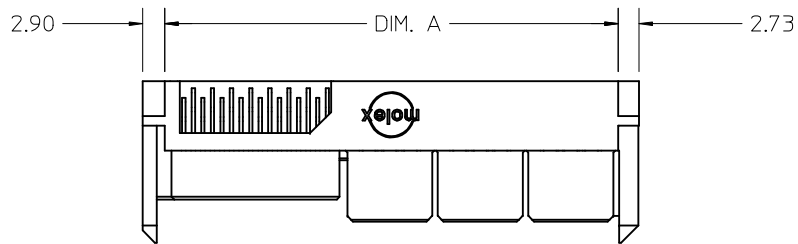

NO OF SIGNALS
OPTIONAL
SEE CHART

OPTIONAL GUIDES

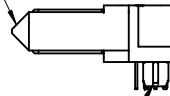

OPTIONAL PEGS

GUIDE POST & MOUNTING PEG OPTIONS

NO OF SIGNAL	MATERIAL NUMBER	DIM A	DIM C	DIM P	PCB THK
12	45984-6411	47.5	49.90	4.50	3.18
16	45984-6421	50.0	52.44		
20	45984-6431	52.6	54.98		
24	45984-6441	55.1	57.52		
28	45984-6451	57.6	60.06		
32	45984-6461	60.2	62.60	3.60	2.36
36	45984-6471	62.7	65.14		
40	45984-6481	65.3	67.68		
12	45984-6412	47.5	49.90		
16	45984-6422	50.0	52.44		
20	45984-6432	52.6	54.98	2.90	1.57
24	45984-6442	55.1	57.52		
28	45984-6452	57.6	60.06		
32	45984-6462	60.2	62.60		
36	45984-6472	62.7	65.14		
40	45984-6482	65.3	67.68	2.90	1.57
12	45984-6413	47.5	49.90		
16	45984-6423	50.0	52.44		
20	45984-6433	52.6	54.98		
24	45984-6443	55.1	57.52		
28	45984-6453	57.6	60.06		
32	45984-6463	60.2	62.60		
36	45984-6473	62.7	65.14		
40	45984-6483	65.3	67.68		

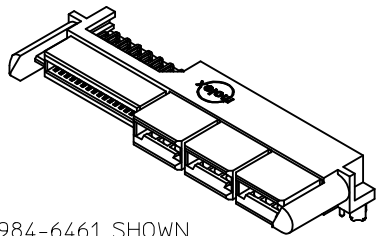

45984-6461 SHOWN
FOR REF ONLY
SEE CHART

REVISED	DESCRIPTION
EC NO: UCP2009-0971	
DRWN:MBANDURA 2008/11/13	
CHKD: 2008/11/14	
APPR:APATEL 2008/11/17	
REV	

GENERAL TOLERANCES
(UNLESS SPECIFIED)

	mm	INCH
4 PLACES	± ---	± ---
3 PLACES	± ---	± ---
2 PLACES	± 0.25	± ---
1 PLACE	± ---	± ---

ANGULAR ±1/2°

DRAFT WHERE APPLICABLE
MUST REMAIN
WITHIN DIMENSIONS

DIMENSION STYLE
MM ONLY

DRAWN BY	DATE
SAMIEC	2005/05/13
CHECKED BY	DATE
SAMIEC	2005/05/13
APPROVED BY	DATE
MARGULIS	2005/05/13
MATERIAL NO.	

SCALE
1:1

DESIGN UNITS
METRIC

THIRD ANGLE
PROJECTION

TITLE
LPH RECEPTACLE ASSEMBLY
RT ANGLE 6 CIRCUIT
POWER CONNECTOR

molex MOLEX INCORPORATED

DOCUMENT NO.
SD-45984-600

SHEET NO.
4 OF 5

THIS DRAWING CONTAINS INFORMATION THAT IS PROPRIETARY TO MOLEX
INCORPORATED AND SHOULD NOT BE USED WITHOUT WRITTEN PERMISSION

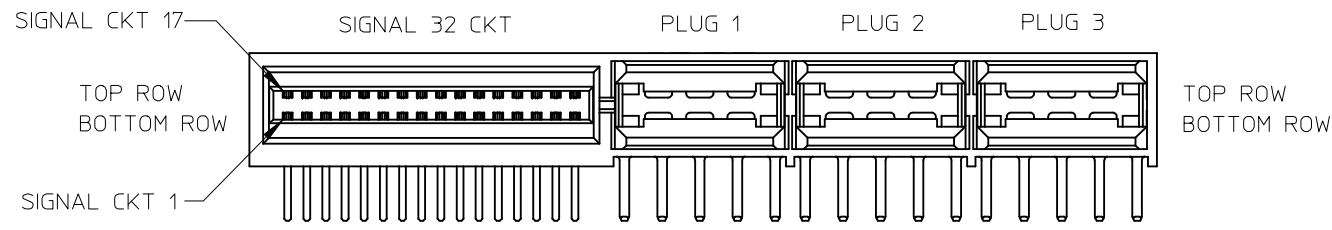

NO. OF SIGNAL	DIM. D
12	8.00
16	10.54
20	13.08
24	15.62
28	18.16
32	20.70
36	23.24
40	25.78

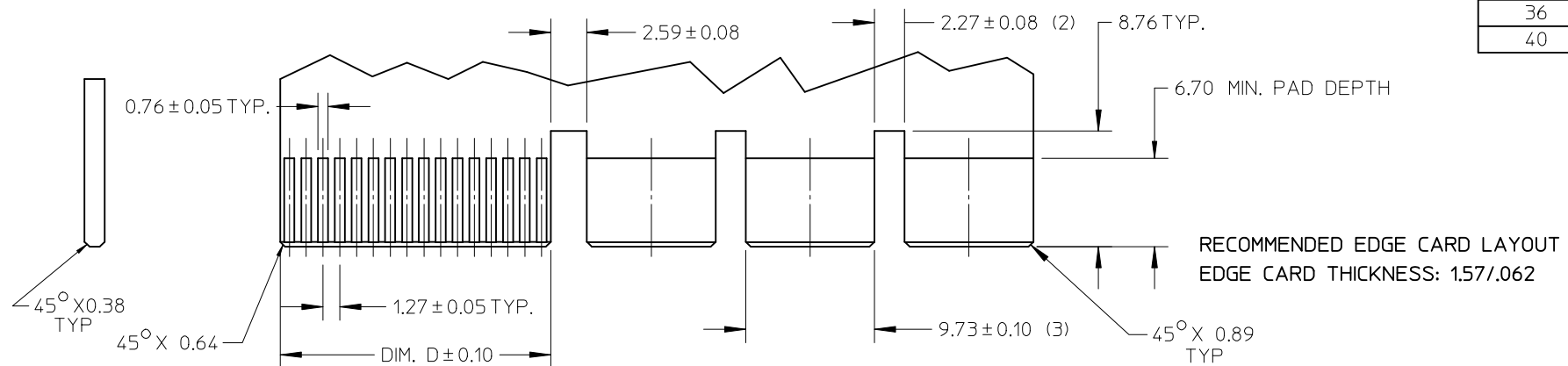

RECOMMENDED EDGE CARD LAYOUT
EDGE CARD THICKNESS: 1.57/0.62

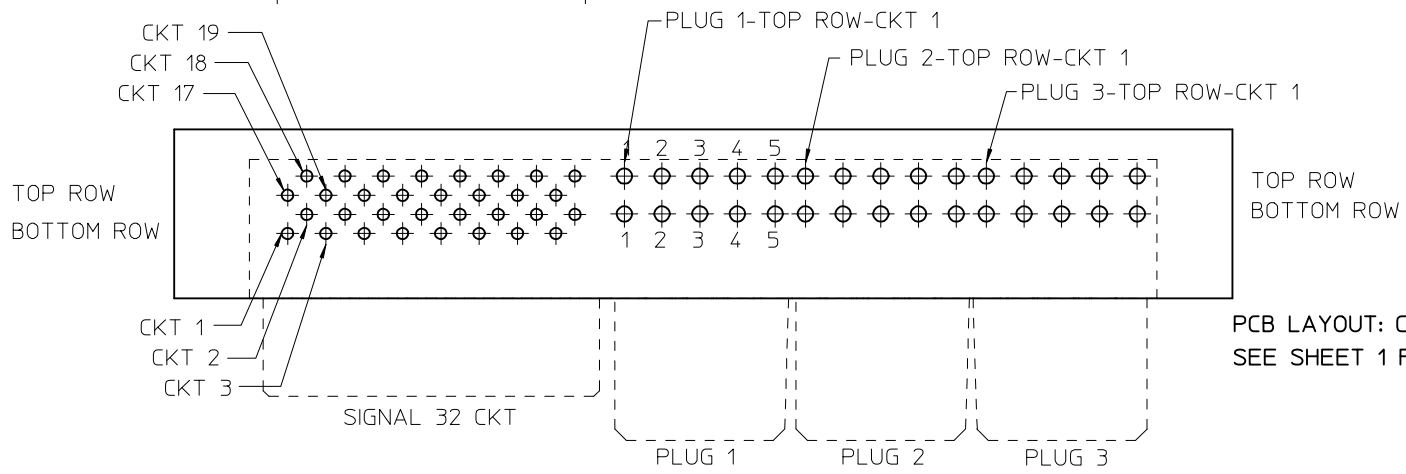

REVISED	EC NO: UCP2009-0971	2008/11/13
DRWN: MBANDURA	2008/11/14	
CHKD:		
APPR: APATEL	2008/11/17	
REV	DESCRIPTION	

GENERAL TOLERANCES (UNLESS SPECIFIED)		
	mm	INCH
4 PLACES	± ---	± ---
3 PLACES	± ---	± ---
2 PLACES	± 0.25	± ---
1 PLACE	± ---	± ---
ANGULAR ± 1/2°		
DRAFT WHERE APPLICABLE MUST REMAIN WITHIN DIMENSIONS		

DIMENSION STYLE	
MM ONLY	
DRAWN BY	DATE
SAMIEC	2005/05/13
CHECKED BY	DATE
SAMIEC	2005/05/13
APPROVED BY	DATE
MARGULIS	2005/05/13
MATERIAL NO.	

SCALE	DESIGN UNITS	THIRD ANGLE PROJECTION
2:1	METRIC	
TITLE		
LPH RECEPTACLE ASSEMBLY RT ANGLE 6 CIRCUIT POWER CONNECTOR		
MOLEX INCORPORATED		
DOCUMENT NO.	SHEET NO.	
SD-45984-600	5 OF 5	