

SPECIFICATION FOR APPROVAL

REF :

PAGE: 1

PROD. NAME	SHIELDED SMD POWER INDUCTOR	ABC'S DWG NO.	SP1204□□□□L□-□□□
		ABC'S ITEM NO.	

. MECHANICAL DIMENSIONS :

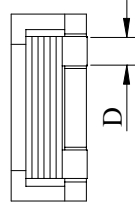
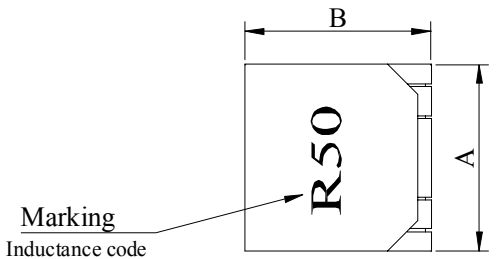

- A : 12.50±0.30 m/m
- B : 12.50±0.30 m/m
- C : 4.00⁺⁰ m/m
- D : 1.90±0.20 m/m
- E : 2.50 nom. m/m
- E1: 3.00 ref. m/m
- E2: 2.00 ref. m/m
- F : 7.50±0.25 m/m
- F1: 6.40 ref. m/m
- F2: 5.20 ref. m/m
- H : 10.50 ref. m/m
- I : 4.15 ref. m/m
- J : 3.00 ref. m/m
- K : 13.00 ref. m/m
- M : 4.70 ref. m/m
- N : 4.50 ref. m/m
- P : 7.50 ref. m/m
- P1 : 3.75 ref. m/m
- P2 : 3.75 ref. m/m

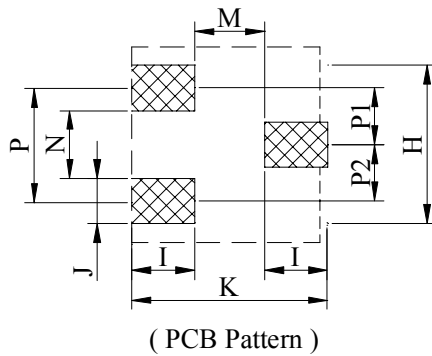
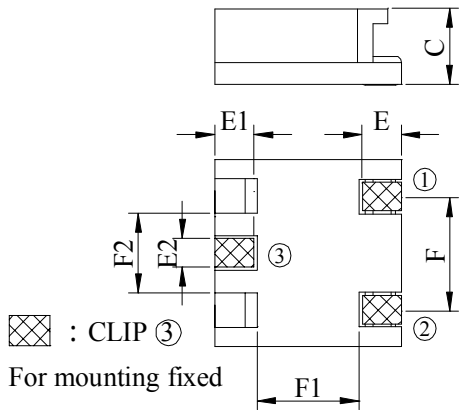

. SCHEMATIC DIAGRAM :

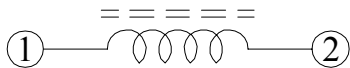

. MATERIALS LIST :

- a . Core : Ferrite ER core
- b . Core : Ferrite SB core
- c . Wire : Ultra-fine rectangular Enamelled copper wire (class F)
- d . Terminal : Cu/Sn
- e . Adhesive : Epoxy resin
- f . Adhesive : Epoxy resin
- g . Remark : Products comply with RoHS' requirements

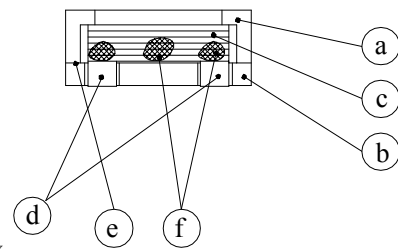

Peak Temp : 260 max.
 Max time above 230 : 50sec max.
 Max time above 200 : 70sec max.

. GENERAL SPECIFICATION :

- a . Temp. rise : 40 max.
- b . Storage temp. : -40 ~ +125
- c . Operating temp. : -40 ~ +105
- d . Resistance to solder heat : 260 . 10 secs.

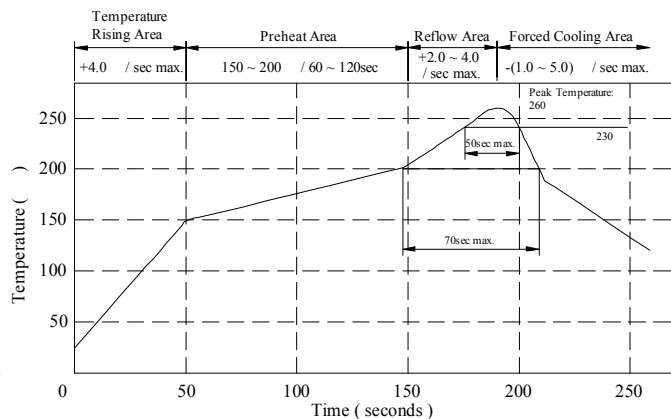

AR-001A

SPECIFICATION FOR APPROVAL

REF :

PAGE: 2

PROD. NAME	SHIELDED SMD POWER INDUCTOR	ABC'S DWG NO.	SP1204□□□□L□-□□□
		ABC'S ITEM NO.	

. ELECTRICAL CHARACTERISTICS :

DWG No.	Initial Inductance L0 (uH)	Inductance at flatpoint L1 (uH)	Flat Point ref. (A)	Irms (A)	Isat (A)	DC Resistance max. (mΩ)
SP1204R50ML□-□□□	0.75±20%	0.55±20%	2.0	13.0	14.0	3.0
SP12041R1ML□-□□□	1.30±20%	1.10±20%	2.0	12.0	13.0	4.5
SP12041R8ML□-□□□	2.00±20%	1.80±20%	2.0	10.0	11.0	6.0

- 1). □ : Packaging information... A : Bulk B : Taping Reel
- 2). "-□□□":Reference code
- 3). Measured Frequency of inductance is 100 KHz / 1V
- 4). Irms Base on temp. rise 40 max.
- 5). Isat Base on inductance drop 20% typ. of L1 Value

@ Inductance VS. DC Superposition Characteristics

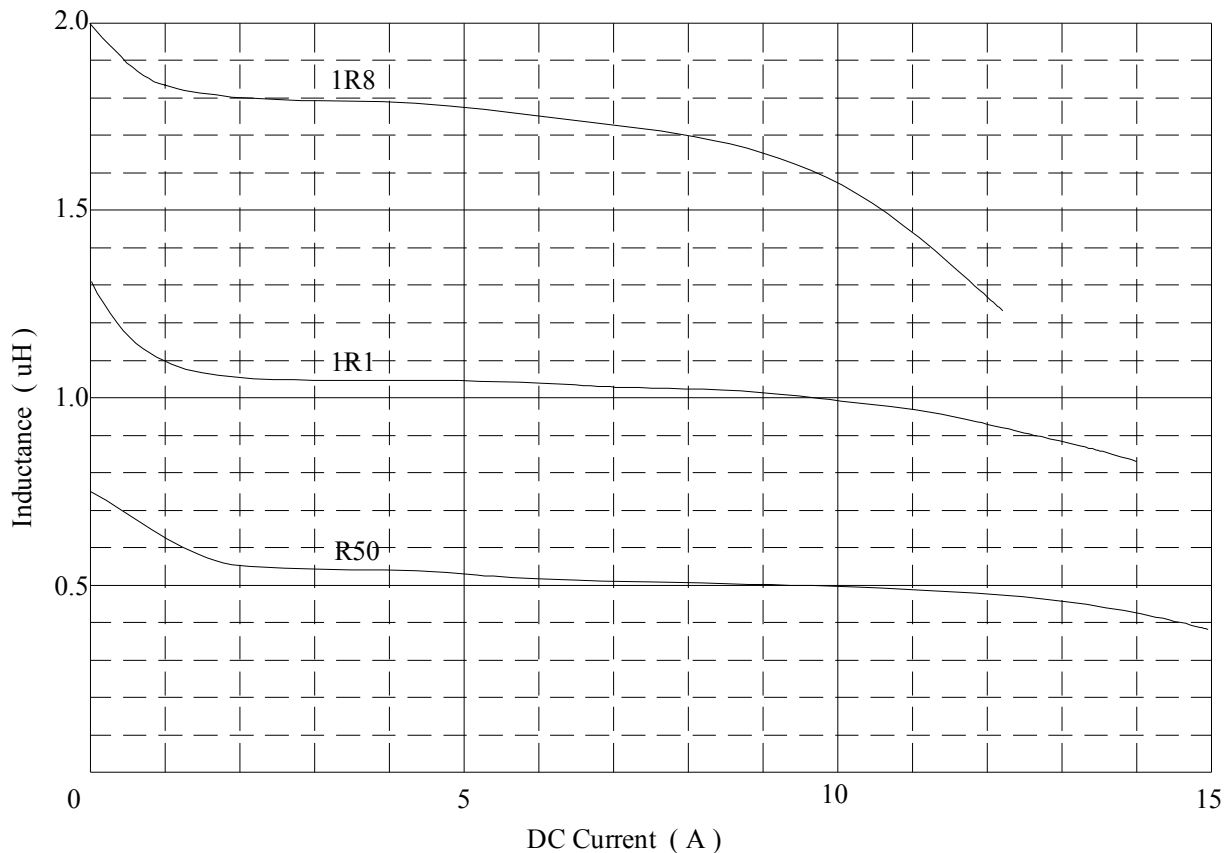

AR-001A



SPECIFICATION FOR APPROVAL

REF :

PAGE: 2

PROD. NAME	SHIELDED SMD POWER INDUCTOR	ABC'S DWG NO.	SP1204□□□□L□-□□□
		ABC'S ITEM NO.	

. ELECTRICAL CHARACTERISTICS :

DWG No.	Initial Inductance L0 (uH)	Inductance at flatpoint L1 (uH)	Flat Point ref. (A)	Irms (A)	Isat (A)	DC Resistance max. (mΩ)
SP1204R50ML□-□□□	0.75±20%	0.55±20%	2.0	13.0	14.0	3.0
SP12041R1ML□-□□□	1.30±20%	1.10±20%	2.0	12.0	13.0	4.5
SP12041R8ML□-□□□	2.00±20%	1.80±20%	2.0	10.0	11.0	6.0

- 1). □ : Packaging information... [A]: Bulk [B]: Taping Reel
- 2). "- □□□ ":Reference code
- 3). Measured Frequency of inductance is 100 KHz / 1V
- 4). Irms Base on temp. rise 40 max.
- 5). Isat Base on inductance drop 20% typ. of L1 Value

@ Inductance VS. DC Superposition Characteristics

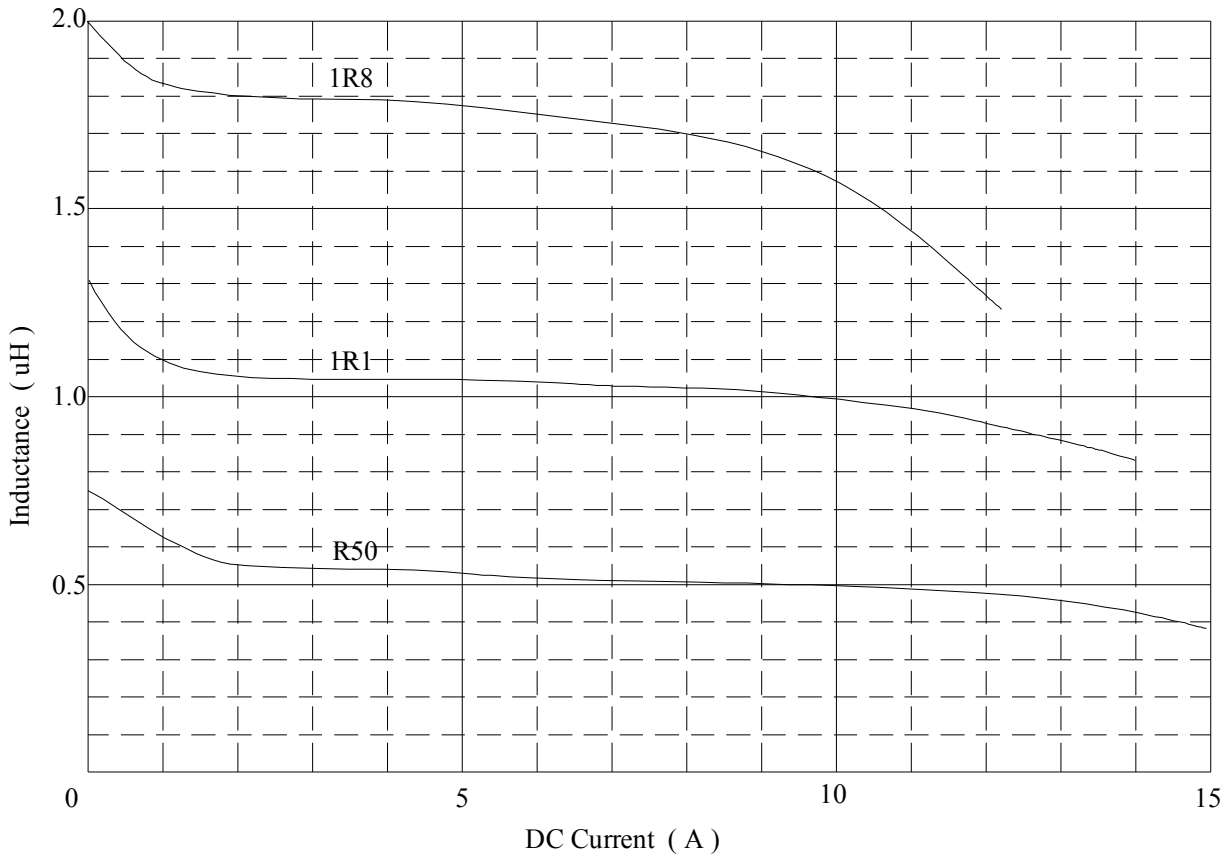

AR-001A

SPECIFICATION FOR APPROVAL

REF :

PAGE: 3

PROD. NAME	SHIELDED SMD POWER INDUCTOR	ABC'S DWG NO.	SP1204□□□□L□-□□□
		ABC'S ITEM NO.	

. PACKAGING INFORMATION :

(1) Configuratonn

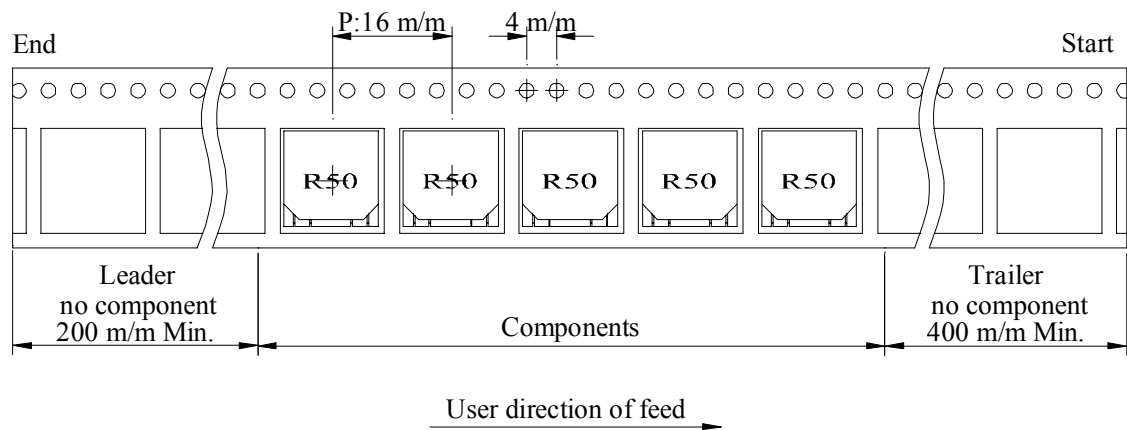
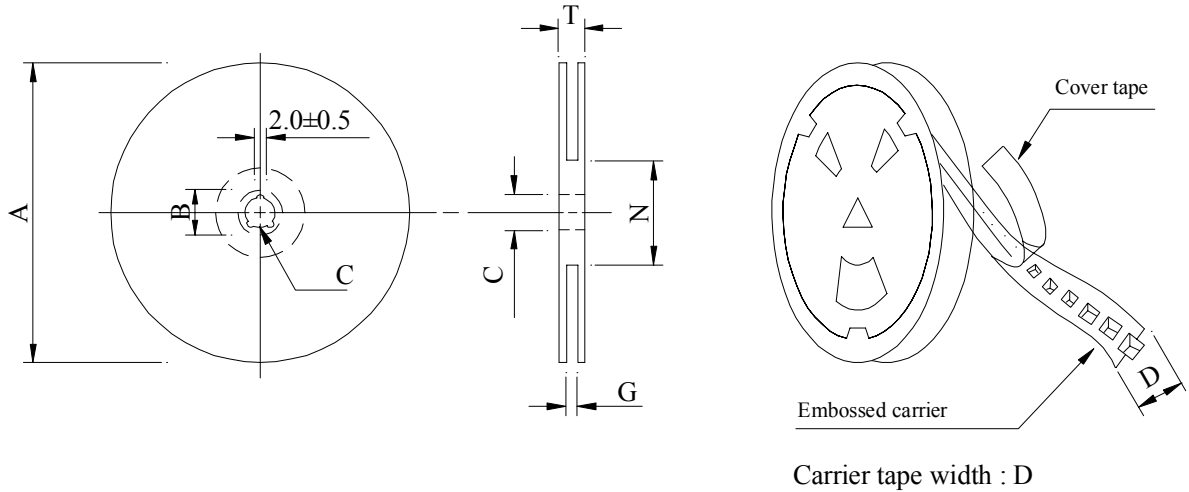

(2) Dimensions

Unit:m/m

Style	A	B	C	D	G	N	T
13 - 24	330	21±0.8	13	24	26 ⁺⁰	50 ⁻⁰	30.4

(3) Q'TY & G.W. Per package

Series	Inner : Reel			Outer : Carton		
	Q'TY (pcs)	G.W. (gw)	Style	Q'TY (pcs)	G.W. (Kg)	Size (cm)
SP1204	800	2,150	13 - 24	3,200	11.30	40 x 40 x 24

AR-001A



SPECIFICATION FOR APPROVAL

REF :

PAGE: 4

PROD. NAME	SHIELDED SMD POWER INDUCTOR	ABC'S DWG NO.	SP1204□□□□L□-□□□
		ABC'S ITEM NO.	

. DWGING NUMBER EXPRESSION :

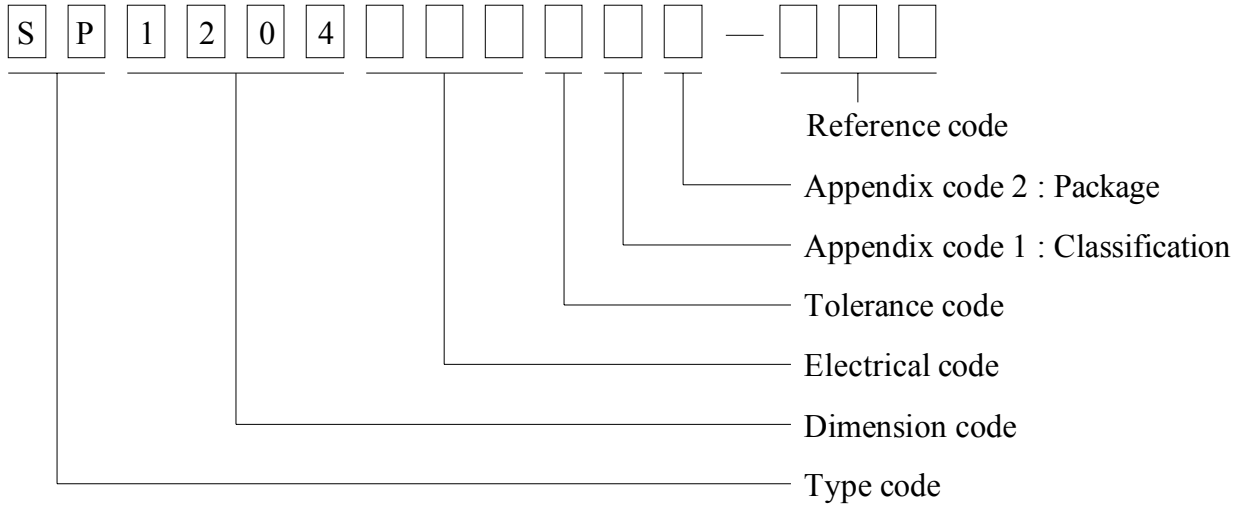

Appendix code 1 : Product Classification

- L : Lead Free Standard products comply with RoHS' requirements
- 1 ~ 9 : Lead Free Special products comply with RoHS' requirements

Appendix code 2 : Package Information

Code	Inner package	Inner package Q'TY	Remark
A	T.B.D.	T.B.D.	
B	T / R (Reel package)	800 pcs	

SPECIFICATION FOR APPROVAL

REF :

PAGE: 5

PROD. NAME	SHIELDED SMD POWER CHOKE	ABC'S DWG NO.	SP1204□□□□L□-□□□
		ABC'S ITEM NO.	

. RELIABILITY TEST :

Test item	Specification	Test condition						
Solderability	More than 90% of the terminal electrode shall be covered With fresh solder.	Preheat : 150±25 for 60 seconds Solder : Sn96.5 / Ag3 / Cu0.5 or equivalent Solder temp. : 235±5 Flux : Rosin Dip time : 4±1 seconds						
Thermal shock test (Temp. cycle)	Inductance shall not change more than ±20%	<table style="width: 100%; border: none;"> <tr> <td style="text-align: center;">Room temp. 15 minutes</td> <td style="text-align: center;">—————></td> <td style="text-align: center;">-25±2 30 minutes</td> </tr> <tr> <td style="text-align: center;">Room temp. 15 minutes</td> <td style="text-align: center;">—————></td> <td style="text-align: center;">85±2 30 minutes</td> </tr> </table> <p>Total : 50 cycles</p>	Room temp. 15 minutes	—————>	-25±2 30 minutes	Room temp. 15 minutes	—————>	85±2 30 minutes
Room temp. 15 minutes	—————>	-25±2 30 minutes						
Room temp. 15 minutes	—————>	85±2 30 minutes						
Humidity Resistance test		Temperature : 40±2 Humidity : 90 ~ 95% Applied current : Per spec. Time : 500 hours						
High temp. Resistance test		Temperature : 105±2 Applied current : Per spec. Time : 500 hours						

AR-001A

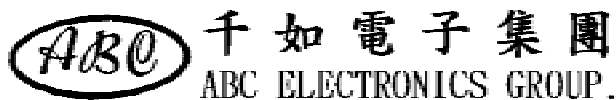

SPECIFICATION FOR APPROVAL

REF :

PAGE: 6

PROD. NAME	SHIELDED SMD POWER INDUCTOR	ABC'S DWG NO.	SP1204□□□□L□-□□□
		ABC'S ITEM NO.	

. UL CARD :

OBMW2	January 7, 1988	
Component-Magnet Wire		E104048 (S)
MITSUBISHI CABLE INDUSTRIES LTD		
4-3 IKEJIRI ITAMI , HYOGO 664 JAPAN		
Mtl	Coat Typ	ANSI
Dsg	BC	Oyercoat
EDW-R52	Medis	Ester-imide
		Temp
		Class
		155
Marking : Company name and type designation on package or reels.		
See General Information Preceding These Recognitions.		
For use only in equipment where the acceptability of the combination is determined by Underwriters Laboratories Inc.		
Report : January 5, 1988.		
302279005	H7642	Underwriters Laboratories Inc.® D11/0149909

AR-001A

