

Features

- Attenuation: 0.5 dB Steps to 15.5 dB
- Low DC Power Consumption
- Small Footprint, JEDEC Package
- Integral TTL Driver
- 50 ohm Impedance
- Test Boards are Available
- Tape and Reel Packaging Available
- CSP-1 Package

Description

M/A-COM's AT90-0283 is a GaAs FET 5-bit digital attenuator with integral TTL driver. Step size is 0.5 dB providing a 15.5 dB total attenuation range. This device is in an PQFN plastic surface mount package. AT90-0283 is ideally suited for use where accuracy, fast speed, very low power consumption and low costs are required.

Functional Schematic

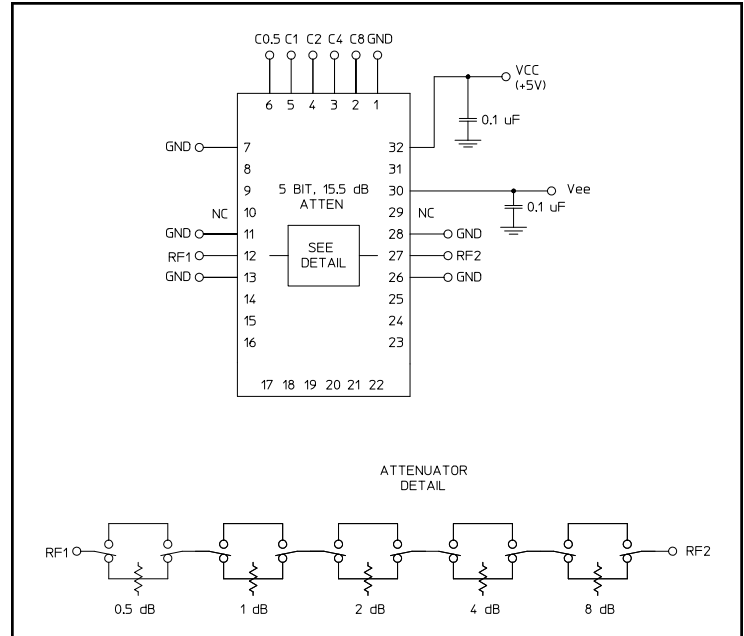

Pin Configuration¹

| Pin No. | Function | Pin No. | Function |
|---------|-----------------|---------|-----------------|
| 1 | GND | 17 | NC |
| 2 | C8 | 18 | NC |
| 3 | C4 | 19 | NC |
| 4 | C2 | 20 | NC |
| 5 | C1 | 21 | NC |
| 6 | C0.5 | 22 | NC |
| 7 | GND | 23 | NC |
| 8 | NC | 24 | NC |
| 9 | NC | 25 | NC |
| 10 | NC ² | 26 | GND |
| 11 | GND | 27 | RF2 |
| 12 | RF1 | 28 | GND |
| 13 | GND | 29 | NC ² |
| 14 | NC | 30 | -Vee |
| 15 | NC | 31 | NC |
| 16 | NC | 32 | +Vcc |

1. The exposed pad centered on the package bottom must be connected to RF and DC ground. (For PQFN Packages)
2. Pins 10 & 29 must be isolated

Ordering Information

| Part Number | Package |
|--------------|-------------------|
| AT90-0283 | Bulk Packaging |
| AT90-0283TR | 1000 piece reel |
| AT90-0283-TB | Sample Test Board |

Note: Reference Application Note M513 for reel size information.

ADVANCED: Data Sheets contain information regarding a product M/A-COM Technology Solutions is considering for development. Performance is based on target specifications, simulated results, and/or prototype measurements. Commitment to develop is not guaranteed.
PRELIMINARY: Data Sheets contain information regarding a product M/A-COM Technology Solutions has under development. Performance is based on engineering tests. Specifications are typical. Mechanical outline has been fixed. Engineering samples and/or test data may be available. Commitment to produce in volume is not guaranteed.

• **North America** Tel: 800.366.2266 • **Europe** Tel: +353.21.244.6400
 • **India** Tel: +91.80.4155721 • **China** Tel: +86.21.2407.1588
 Visit www.macomtech.com for additional data sheets and product information.

M/A-COM Technology Solutions Inc. and its affiliates reserve the right to make changes to the product(s) or information contained herein without notice.

Electrical Specifications: $T_A = 25^\circ\text{C}$, $Z_0 = 50\Omega$

| Parameter | Test Conditions | Frequency | Units | Min | Typ | Max |
|---|--|---------------|--------------------|------|-------|-----------------------------------|
| Insertion Loss | — | DC - 3.5 GHz | dB | — | 2.8 | 3.2 |
| Attenuation Accuracy | Individual Bits 0.5-1-4-8 dB Individual Bit 2 dB Any Combination of Bits 1 to 15.5 dB | DC - 3.5 GHz | dB | — | — | $\pm(.3 + 5\%$ of atten setting) |
| | | DC - 3.5 GHz | dB | — | — | $\pm(.4 + 10\%$ of atten setting) |
| | | DC - 3.5 GHz | dB | — | — | $\pm(.5 + 7\%$ of atten setting) |
| VSWR | Full Range | DC - 3.5 GHz | Ratio | — | 1.6:1 | 1.8:1 |
| Switching Speed | 50% Cntl to 90%/10% RF 10% to 90% or 90% to 10% | — | ns | — | 75 | 150 |
| | | — | ns | — | 20 | 50 |
| 1 dB Compression | — | 50 MHz | dBm | — | +21 | — |
| | | 0.5 - 3.5 GHz | dBm | — | +29 | — |
| Input IP_3 | Two-tone inputs up to +5 dBm | 50 MHz | dB | — | +35 | — |
| | | 0.5-3.5 GHz | dB | — | +48 | — |
| V_{CC} | — | — | V | 4.75 | 5.0 | 5.25 |
| V_{EE} | — | — | V | -8.0 | -5.0 | -4.75 |
| V_{IL} | LOW-level input voltage | — | V | 0.0 | — | 0.8 |
| V_{IH} | HIGH-level input voltage | — | V | 2.0 | — | 5.0 |
| I_{in} (Input Leakage Current) | $V_{in} = V_{CC}$ or GND | — | μA | -1.0 | — | 1.0 |
| I_{CC} (Quiescent Supply Current) | $V_{cntrl} = V_{CC}$ or GND | — | μA | — | 250 | 400 |
| ΔI_{CC} (Additional Supply Current Per TTL Input Pin) | $V_{CC} = \text{Max}$, $V_{cntrl} = V_{CC} - 2.1 \text{ V}$ | — | mA | — | — | 1.0 |
| I_{EE} | V_{EE} min to max, $V_{in} = V_{IL}$ or V_{IH} | — | mA | -1.0 | -0.2 | — |
| Thermal Resistance θ_{jc} | — | — | $^\circ\text{C/W}$ | — | 15 | — |

Absolute Maximum Ratings ^{3,4}

| Parameter | Absolute Maximum |
|---|---|
| Max. Input Power 0.05 GHz 0.5 - 3.5 GHz | +27 dBm +34 dBm |
| V_{CC} | $-0.5V \leq V_{CC} \leq +7.0V$ |
| V_{EE} | $-8.5V \leq V_{EE} \leq +0.5V$ |
| $V_{CC} - V_{EE}$ | $-0.5V \leq V_{CC} - V_{EE} \leq 14.5V$ |
| V_{in}^5 | $-0.5V \leq V_{in} \leq V_{CC} + 0.5V$ |
| Operating Temperature | -40°C to +85°C |
| Storage Temperature | -65°C to +125°C |

- Exceeding any one or combination of these limits may cause permanent damage to this device.
- M/A-COM does not recommend sustained operation near these survivability limits.
- Standard CMOS TTL interface, latch-up will occur if logic signal is applied prior to power supply.

Handling Procedures

Please observe the following precautions to avoid damage:

Static Sensitivity

Gallium Arsenide Integrated Circuits are sensitive to electrostatic discharge (ESD) and can be damaged by static electricity. Proper ESD control techniques should be used when handling these devices.

Moisture Sensitivity

The MSL rating for this part is defined as Level 2 per IPC/JEDEC J-STD-020. Parts shall be stored and/or baked as required for MSL Level 2 parts.

Recommended PCB Configuration ⁶

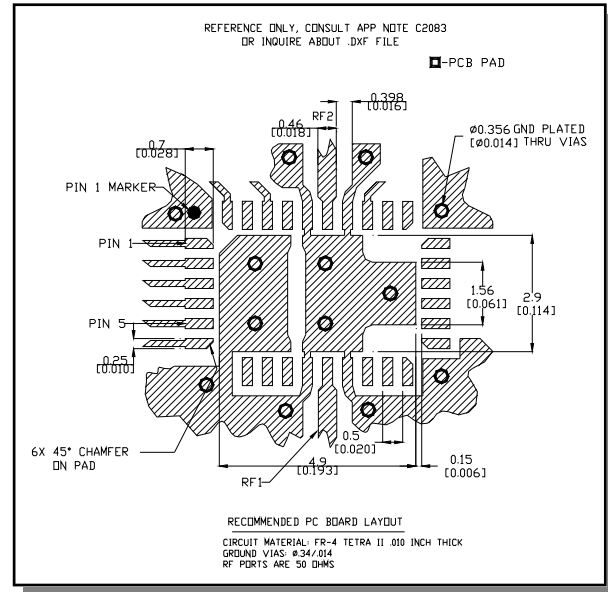

- Application Note C2083 is available on line at www.macom.com

Truth Table (Digital Attenuator)

| C8 | C4 | C2 | C1 | C0.5 | Attenuation |
|----|----|----|----|------|-----------------|
| 0 | 0 | 0 | 0 | 0 | Loss, Reference |
| 0 | 0 | 0 | 0 | 1 | 0.5 dB |
| 0 | 0 | 0 | 1 | 0 | 1.0 dB |
| 0 | 0 | 1 | 0 | 0 | 2.0 dB |
| 0 | 1 | 0 | 0 | 0 | 4.0 dB |
| 1 | 0 | 0 | 0 | 0 | 8.0 dB |
| 1 | 1 | 1 | 1 | 1 | 15.5 dB |

0 = TTL Low; 1 = TTL High

Typical Performance Curves

Insertion Loss

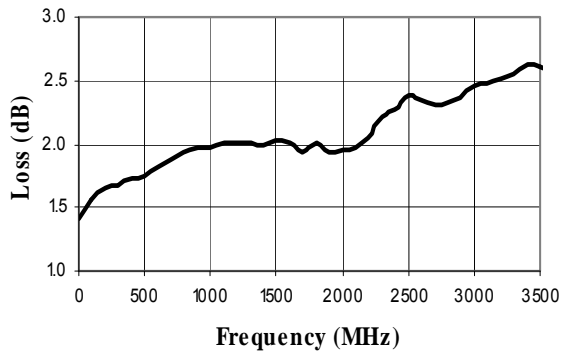

VSWR @ Insertion Loss

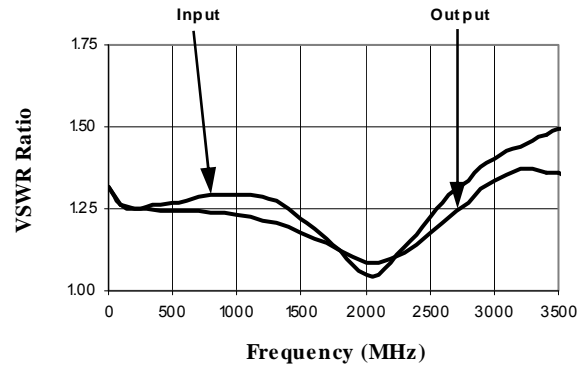

Attenuation Error, 0.5 dB Bit

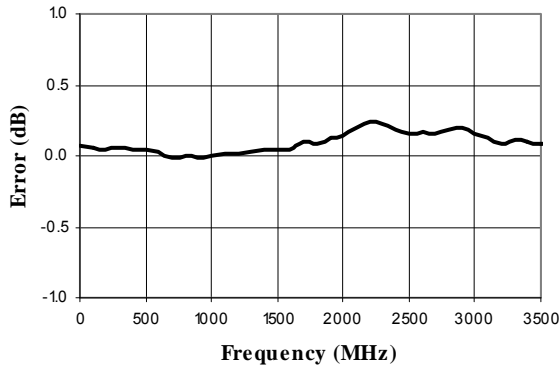

Attenuation Error, 1 dB Bit

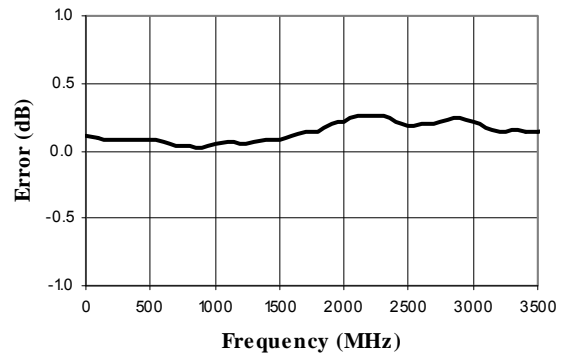

Attenuation Error, 2 dB Bit

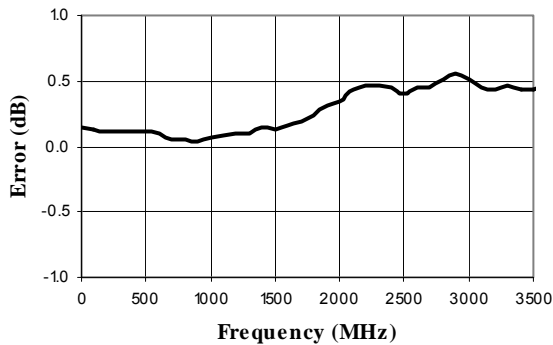

Attenuation Error, 4 dB Bit

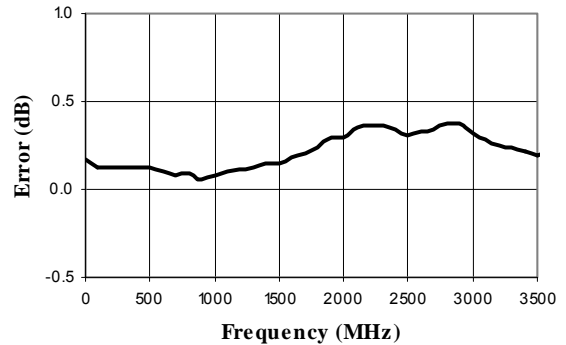

Typical Performance Curves

Attenuation Error, 8 dB Bit

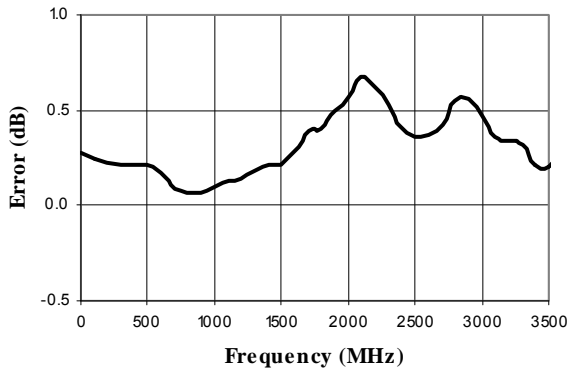

Attenuation Error, Max. Attenuation

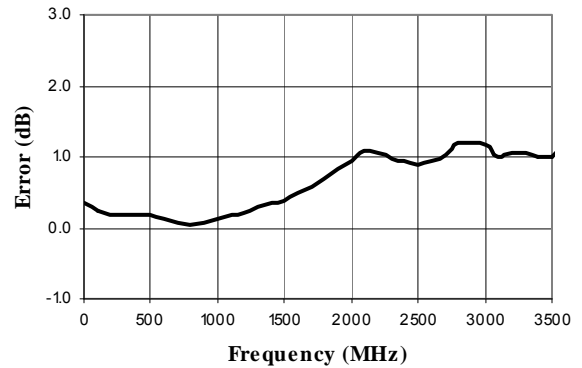

VSWR, 0.5 dB Bit

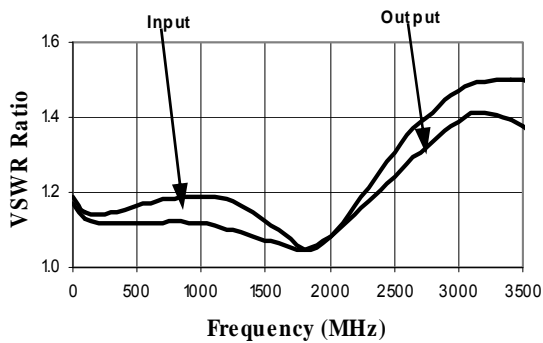

VSWR, 1 dB Bit

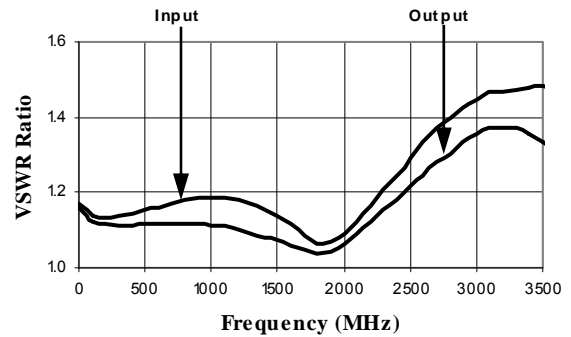

Typical Performance Curves

VSWR, 2 dB Bit

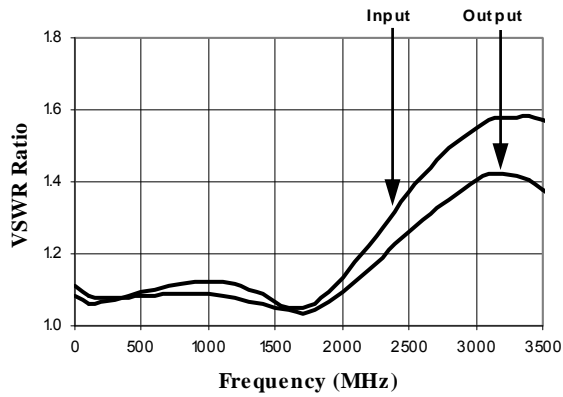

VSWR, 4 dB Bit

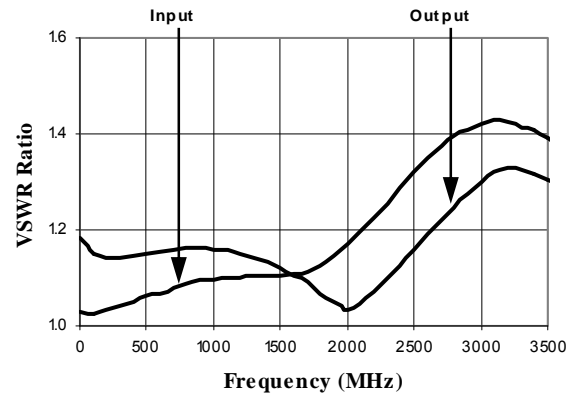

VSWR, 8 dB Bit

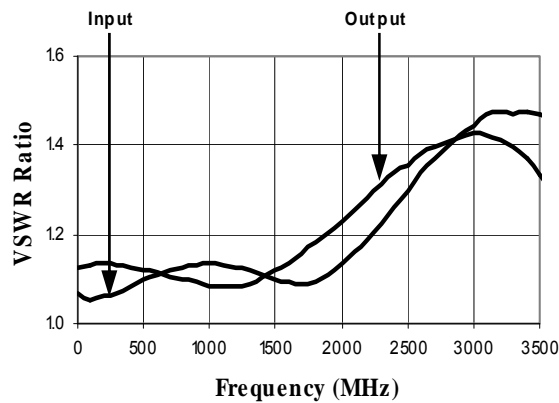

VSWR, Maximum Attenuation

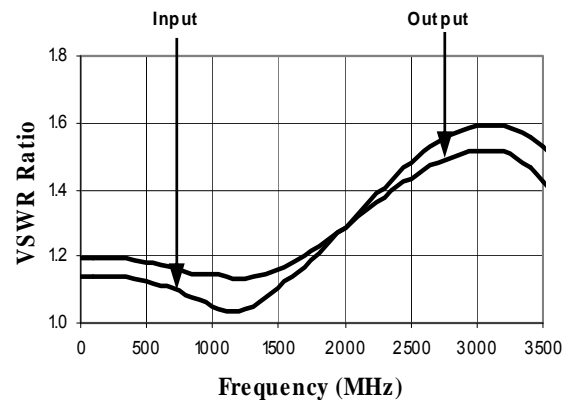

AT90-0283

Digital Attenuator
15.5 dB, 5-Bit, TTL Driver, DC-3.5 GHz

Rev. V10

CSP-1, 4 x 6 mm, 32-lead PQFN†

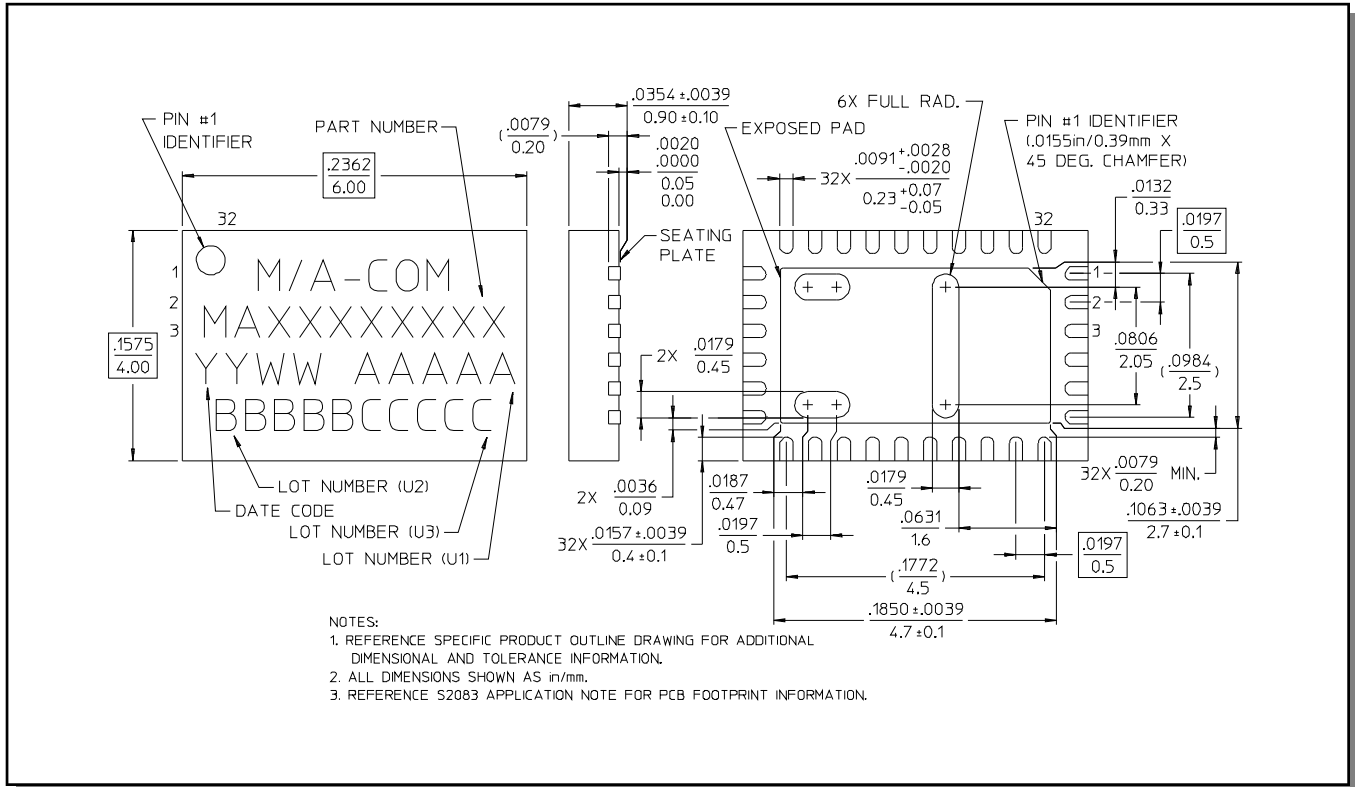

† Reference Application Note M538 for lead-free solder reflow recommendations.